



NEXCOM International Co., Ltd.

IoT Automation Solutions Business Group

PC-based Factory Automation System

NIFE 200 Series

User Manual

CONTENTS

Preface

Copyright	iv
Disclaimer	iv
Acknowledgements	iv
Regulatory Compliance Statements	iv
Declaration of Conformity	iv
RoHS Compliance	v
Warranty and RMA	vi
Safety Information	viii
Installation Recommendations	viii
Safety Precautions	ix
Technical Support and Assistance	x
Conventions Used in this Manual	x
Global Service Contact Information	xi
Package Contents	xiii
Ordering Information	xiv

Chapter 1: Product Introduction

Overview	1
Key Features	1
Hardware Specifications	2
Knowing Your NIFE 200/200P2	4
Front View	4
Top View	5
Mechanical Dimensions	6

NIFE 200	6
NIFE 200P2	7

Chapter 2: Jumpers and Connectors

Before You Begin	8
Precautions	8
Jumper Settings	9
Locations of the Jumpers and Connectors for NIFB 200	10
Jumpers	11
AT/ATX Mode Select	11
RTC Connector	11
Connector Pin Definitions	12
External I/O Interfaces - Front Panel	12
DVI-I Connector	12
DisplayPort Connector	12
LAN1 and USB 3.0/USB 2.0 Ports	13
LAN2 and USB 2.0 Ports	14
COM 1 Port (RS232/422/485)	15
COM 2 Port (RS232/422/485)	15
24V DC Power Input	16
LED Indicators	16
Internal Connectors	17
SATA Connector	17
SATA Power Connector	17
Internal USB Dongle Connector	18
SD Card Slot	18



- Debug Card Connector 19
- Line-out Pin Header..... 19
- Power Connector..... 20
- PS2 KB/MS Pin Header 20
- Remote Push Button Connector 21
- System Reset Connector..... 21
- Battery Connector..... 22
- Internal COM3 Connector..... 22
- Internal COM4 Connector..... 23
- Internal GPIO Pin Header..... 23
- Mini-PCIe Connector..... 24
- Mini-PCIe Connector..... 25

Chapter 3: System Setup

- Installing a SO-DIMM Memory Module 26
- Installing a 2.5" SATA HDD 29
- Installing a Mini-PCIe Module (Half-Size) 32
- Installing a Mini-PCIe Module (Full-Size) 35
- Installing a SD Card or SIM Card 37
 - SD Card Installation Instructions 37
 - SIM Card Installation Instructions..... 39
- Installing an Antenna or Audio Cable..... 41
 - Antenna Installation Instructions..... 41
 - Audio Cable Installation Instructions..... 43
- Removing the Side Cover 45
- Installing a PCI or PCIe Card 47

Chapter 4: BIOS Setup

- About BIOS Setup 53
- When to Configure the BIOS..... 53
- Default Configuration 54

- Entering Setup 54
- Legends 54
- BIOS Setup Utility..... 56
 - Main 56
 - Advanced 57
 - Chipset..... 64
 - Security 66
 - Boot..... 67
 - Save & Exit 67

Appendix A: Power Consumption68

Appendix B: GPI/O Programming Guide69

Appendix C: Watchdog Timer Setting.....71

Appendix D: LED Programming Guide72

PREFACE

Copyright

This publication, including all photographs, illustrations and software, is protected under international copyright laws, with all rights reserved. No part of this manual may be reproduced, copied, translated or transmitted in any form or by any means without the prior written consent from NEXCOM International Co., Ltd.

Disclaimer

The information in this document is subject to change without prior notice and does not represent commitment from NEXCOM International Co., Ltd. However, users may update their knowledge of any product in use by constantly checking its manual posted on our website: <http://www.nexcom.com>. NEXCOM shall not be liable for direct, indirect, special, incidental, or consequential damages arising out of the use of any product, nor for any infringements upon the rights of third parties, which may result from such use. Any implied warranties of merchantability or fitness for any particular purpose is also disclaimed.

Acknowledgements

NIFE 200, NIFE 200P2 and NIFE 200P2E are trademarks of NEXCOM International Co., Ltd. All other product names mentioned herein are registered trademarks of their respective owners.

Regulatory Compliance Statements

This section provides the FCC compliance statement for Class A devices and describes how to keep the system CE compliant.

Declaration of Conformity

FCC

This equipment has been tested and verified to comply with the limits for a Class A digital device, pursuant to Part 15 of FCC Rules. These limits are designed to provide reasonable protection against harmful interference when the equipment is operated in a commercial environment. This equipment generates, uses, and can radiate radio frequency energy and, if not installed and used in accordance with the instructions, may cause harmful interference to radio communications. Operation of this equipment in a residential area (domestic environment) is likely to cause harmful interference, in which case the user will be required to correct the interference (take adequate measures) at their own expense.

CE

The product(s) described in this manual complies with all applicable European Union (CE) directives if it has a CE marking. For computer systems to remain CE compliant, only CE-compliant parts may be used. Maintaining CE compliance also requires proper cable and cabling techniques.

RoHS Compliance



NEXCOM RoHS Environmental Policy and Status Update

NEXCOM is a global citizen for building the digital infrastructure. We are committed to providing green products and services, which are compliant with European Union RoHS (Restriction on Use of Hazardous Substance in Electronic Equipment) directive 2011/65/EU, to be your trusted green partner and to protect our environment.

RoHS restricts the use of Lead (Pb) < 0.1% or 1,000ppm, Mercury (Hg) < 0.1% or 1,000ppm, Cadmium (Cd) < 0.01% or 100ppm, Hexavalent Chromium (Cr6+) < 0.1% or 1,000ppm, Polybrominated biphenyls (PBB) < 0.1% or 1,000ppm, and Polybrominated diphenyl Ethers (PBDE) < 0.1% or 1,000ppm.

In order to meet the RoHS compliant directives, NEXCOM has established an engineering and manufacturing task force to implement the introduction of green products. The task force will ensure that we follow the standard NEXCOM development procedure and that all the new RoHS components and new manufacturing processes maintain the highest industry quality levels for which NEXCOM are renowned.

The model selection criteria will be based on market demand. Vendors and suppliers will ensure that all designed components will be RoHS compliant.

How to recognize NEXCOM RoHS Products?

For existing products where there are non-RoHS and RoHS versions, the suffix "(LF)" will be added to the compliant product name.

All new product models launched after January 2013 will be RoHS compliant. They will use the usual NEXCOM naming convention.

Warranty and RMA

NEXCOM Warranty Period

NEXCOM manufactures products that are new or equivalent to new in accordance with industry standard. NEXCOM warrants that products will be free from defect in material and workmanship for 2 years, beginning on the date of invoice by NEXCOM.

NEXCOM Return Merchandise Authorization (RMA)

- Customers shall enclose the “NEXCOM RMA Service Form” with the returned packages.
- Customers must collect all the information about the problems encountered and note anything abnormal or, print out any on-screen messages, and describe the problems on the “NEXCOM RMA Service Form” for the RMA number apply process.
- Customers can send back the faulty products with or without accessories (manuals, cable, etc.) and any components from the card, such as CPU and RAM. If the components were suspected as part of the problems, please note clearly which components are included. Otherwise, NEXCOM is not responsible for the devices/parts.
- Customers are responsible for the safe packaging of defective products, making sure it is durable enough to be resistant against further damage and deterioration during transportation. In case of damages occurred during transportation, the repair is treated as “Out of Warranty.”
- Any products returned by NEXCOM to other locations besides the customers’ site will bear an extra charge and will be billed to the customer.

Repair Service Charges for Out-of-Warranty Products

NEXCOM will charge for out-of-warranty products in two categories, one is basic diagnostic fee and another is component (product) fee.

System Level

- Component fee: NEXCOM will only charge for main components such as SMD chip, BGA chip, etc. Passive components will be repaired for free, ex: resistor, capacitor.
- Items will be replaced with NEXCOM products if the original one cannot be repaired. Ex: motherboard, power supply, etc.
- Replace with 3rd party products if needed.
- If RMA goods can not be repaired, NEXCOM will return it to the customer without any charge.

Board Level

- Component fee: NEXCOM will only charge for main components, such as SMD chip, BGA chip, etc. Passive components will be repaired for free, ex: resistors, capacitors.
- If RMA goods can not be repaired, NEXCOM will return it to the customer without any charge.

Warnings

Read and adhere to all warnings, cautions, and notices in this guide and the documentation supplied with the chassis, power supply, and accessory modules. If the instructions for the chassis and power supply are inconsistent with these instructions or the instructions for accessory modules, contact the supplier to find out how you can ensure that your computer meets safety and regulatory requirements.

Cautions

Electrostatic discharge (ESD) can damage system components. Do the described procedures only at an ESD workstation. If no such station is available, you can provide some ESD protection by wearing an antistatic wrist strap and attaching it to a metal part of the computer chassis.

Safety Information

Before installing and using the device, note the following precautions:

- Read all instructions carefully.
- Do not place the unit on an unstable surface, cart, or stand.
- Follow all warnings and cautions in this manual.
- When replacing parts, ensure that your service technician uses parts specified by the manufacturer.
- Avoid using the system near water, in direct sunlight, or near a heating device.
- The load of the system unit does not solely rely for support from the rackmounts located on the sides. Firm support from the bottom is highly necessary in order to provide balance stability.
- The computer is provided with a battery-powered real-time clock circuit. There is a danger of explosion if battery is incorrectly replaced. Replace only with the same or equivalent type recommended by the manufacturer. Discard used batteries according to the manufacturer's instructions.

Installation Recommendations

Ensure you have a stable, clean working environment. Dust and dirt can get into components and cause a malfunction. Use containers to keep small components separated.

Adequate lighting and proper tools can prevent you from accidentally damaging the internal components. Most of the procedures that follow require only a few simple tools, including the following:

- A Philips screwdriver
- A flat-tipped screwdriver
- A grounding strap
- An anti-static pad

Using your fingers can disconnect most of the connections. It is recommended that you do not use needle-nose pliers to disconnect connections as these can damage the soft metal or plastic parts of the connectors.

Safety Precautions

1. Read these safety instructions carefully.
2. Keep this User Manual for later reference.
3. Disconnect this equipment from any AC outlet before cleaning. Use a damp cloth. Do not use liquid or spray detergents for cleaning.
4. For plug-in equipment, the power outlet socket must be located near the equipment and must be easily accessible.
5. Keep this equipment away from humidity.
6. Put this equipment on a stable surface during installation. Dropping it or letting it fall may cause damage.
7. The openings on the enclosure are for air convection to protect the equipment from overheating. DO NOT COVER THE OPENINGS.
8. Make sure the voltage of the power source is correct before connecting the equipment to the power outlet.
9. Place the power cord in a way so that people will not step on it. Do not place anything on top of the power cord. Use a power cord that has been approved for use with the product and that it matches the voltage and current marked on the product's electrical range label. The voltage and current rating of the cord must be greater than the voltage and current rating marked on the product.
10. All cautions and warnings on the equipment should be noted.
11. If the equipment is not used for a long time, disconnect it from the power source to avoid damage by transient overvoltage.
12. Never pour any liquid into an opening. This may cause fire or electrical shock.
13. Never open the equipment. For safety reasons, the equipment should be opened only by qualified service personnel.
14. If one of the following situations arises, get the equipment checked by service personnel:
 - a. The power cord or plug is damaged.
 - b. Liquid has penetrated into the equipment.
 - c. The equipment has been exposed to moisture.
 - d. The equipment does not work well, or you cannot get it to work according to the user's manual.
 - e. The equipment has been dropped and damaged.
 - f. The equipment has obvious signs of breakage.
15. Do not place heavy objects on the equipment.
16. The unit uses a three-wire ground cable which is equipped with a third pin to ground the unit and prevent electric shock. Do not defeat the purpose of this pin. If your outlet does not support this kind of plug, contact your electrician to replace your obsolete outlet.
17. CAUTION: DANGER OF EXPLOSION IF BATTERY IS INCORRECTLY REPLACED. REPLACE ONLY WITH THE SAME OR EQUIVALENT TYPE RECOMMENDED BY THE MANUFACTURER. DISCARD USED BATTERIES ACCORDING TO THE MANUFACTURER'S INSTRUCTIONS.
18. This product is intended to be supplied by a Listed Power Adapter, suitable for use at Tma 55 degree C whose output meets SELV and rating is 24Vdc, 2.5A min.

Technical Support and Assistance

1. For the most updated information of NEXCOM products, visit NEXCOM's website at www.nexcom.com.
2. For technical issues that require contacting our technical support team or sales representative, please have the following information ready before calling:
 - Product name and serial number
 - Detailed information of the peripheral devices
 - Detailed information of the installed software (operating system, version, application software, etc.)
 - A complete description of the problem
 - The exact wordings of the error messages

Warning!

1. Handling the unit: carry the unit with both hands and handle it with care.
2. Maintenance: to keep the unit clean, use only approved cleaning products or clean with a dry cloth.
3. CompactFlash: Turn off the unit's power before inserting or removing a CompactFlash storage card.

Conventions Used in this Manual



Warning:

Information about certain situations, which if not observed, can cause personal injury. This will prevent injury to yourself when performing a task.



Caution:

Information to avoid damaging components or losing data.



Note:

Provides additional information to complete a task easily.

Global Service Contact Information

Headquarters

NEXCOM International Co., Ltd.

9F, No. 920, Chung-Cheng Rd.,
Zhonghe District, New Taipei City, 23586,
Taiwan, R.O.C.
Tel: +886-2-8226-7786
Fax: +886-2-8226-7782
www.nexcom.com

Asia

Taiwan

NexAIoT Headquarters

Industry 4.0 and Cloud Services

13F, No.916, Zhongzheng Rd.,
Zhonghe District, New Taipei City,
23586, Taiwan, R.O.C.
Tel: +886-2-8226-7796
Fax: +886-2-8226-7926
Email: sales@nexaiot.com
www.nexaiot.com

NexAIoT Co., Ltd.

Taichung Office

16F, No.250, Sec. 2, Chongde Rd.,
Beitun District,
Taichung City, 406, Taiwan, R.O.C.
Tel: +886-4-2249-1179
Fax: +886-4-2249-1172
Email: sales@nexaiot.com
www.nexaiot.com

NexCOBOT Taiwan Co., Ltd.

13F, No.916, Chung-Cheng Rd.,
Zhonghe District,
New Taipei City, 23586, Taiwan, R.O.C.
Tel: +886-2-8226-7786
Fax: +886-2-8226-7926
Email: sales@nexcobot.com
www.nexcobot.com

GreenBase Technology Corp.

13F, No.922, Chung-Cheng Rd.,
Zhonghe District,
New Taipei City, 23586, Taiwan, R.O.C.
Tel: +886-2-8226-7786
Fax: +886-2-8226-7900
Email: sales@nexcom.com.tw
www.nexcom.com.tw

EMBUX Technology Co., Ltd.

13F, No.916, Chung-Cheng Rd.,
Zhonghe District,
New Taipei City, 23586, Taiwan, R.O.C.
Tel: +886-2-8226-7786
Fax: +886-2-8226-7782
Email: sales@nexcom.com.tw
www.nexcom.com.tw

TMR Technology Corp.

13F, No.916, Chung-Cheng Rd.,
Zhonghe District,
New Taipei City, 23586, Taiwan, R.O.C.
Tel: +886-2-8226-7786
Fax: +886-2-8226-7782
Email: sales@nexcom.com.tw
www.nexcom.com.tw

China

NEXSEC Incorporated

5F, No.4, No.7 Fengxian Middle Rd.,
(Beike Industrial Park), Haidian District,
Beijing, 100094, China
Tel: +86-10-5704-2680
Fax: +86-10-5704-2681
Email: marketing@nexsec.cn
www.nexsec.cn

NEXCOM Shanghai

No.4, 16 Building,
Shanghai OMNI Tech & Science Park
No. 1699, Douhui Rd.,
Shanghai, 201108, China
Tel: +86-21-5278-5868
Fax: +86-21-3251-6358
Email: sales@nexcom.cn
www.nexcom.cn

NEXCOM Surveillance Technology Corp.

5F, Building C, ZhenHan Industrial Zone,
GanKeng Community, Buji Street,
LongGang District,
ShenZhen, 518112, China
Tel: +86-755-8364-7768
Fax: +86-755-8364-7738
Email: steveyang@nexcom.com.tw
www.nexcom.cn

NEXCOM United System Service

Room 603/604, Huiyinmingzun Plaza Bldg. 1,
No. 609, Yunlin East Rd.,
Shanghai, 200062, China
Tel: +86-21-5278-5868
Fax: +86-21-3251-6358
Email: renwang@nexcom.com.tw
www.nexcom.cn

NEXGOL Chongqing

1F, Building B4, Electronic 2nd Area,
(Phoenix Lake Industrial Park), Yongchuan Dist.,
Chongqing City, 402160, China
Tel: +86-23-4960-9080
Fax: +86-23-4966-5855
Email: sales@nexgol.com.cn
www.nexcobot.com/NexGOL

NexCOBOT China

Room 501, Building 1, Haichuang Building,
No.7 Qingyi Road, Guicheng Street,
Nanhai District, Foshan City,
Guangdong Province, 528314, China
Tel: +86-757-8625-7118
Email: sales@nexcobot.com
www.nexcobot.com.cn

Beijing NexGemo Technology Co.,Ltd.

5F, Gemotech Building, No.1, Development Rd.,
Changping International Information Industry Base,
Changping District,
Beijing, 102206, China
Tel: +86-10-8190-9328
Fax: +86-10-8190-9456
Email: sales@gemotech.cn
www.nexgemo.cn

Japan

NEXCOM Japan

9F, Tamachi Hara Bldg.,
4-11-5, Shiba Minato-ku,
Tokyo, 108-0014, Japan
Tel: +81-3-5419-7830
Fax: +81-3-5419-7832
Email: sales@nexcom-jp.com
www.nexcom-jp.com

America

USA NEXCOM USA

46665 Fremont Blvd.,
Fremont CA 94538, USA
Tel: +1-510-656-2248
Fax: +1-510-656-2158
Email: sales@nexcom.com
www.nexcomusa.com

Europe

United Kingdom NEXCOM EUROPE

10 Vincent Avenue,
Crownhill Business Centre,
Milton Keynes, Buckinghamshire
MK8 0AB, United Kingdom
Tel: +44-1908-267121
Fax: +44-1908-262042
Email: sales.uk@nexcom.eu
www.nexcom.co.uk

Package Contents

Before continuing, verify that the package that you received is complete. Your package should have all the items listed in the following table.

Item	Part Number	Description	Specification	Qty
1	4NCPF00310X00	Terminal Blocks 3P Phoenix Contact:1803581	3.81mm Female DIP Green	1
2	4NCPM00302X00	(T)Terminal Blocks 3P Phoenix Contact:1777992	5.08mm Male DIP Green	1
3	50311F0295X00	Flat Head Screw Long Fei:F2x4 NYLOK NIGP	F2x4 NIGP NYLOK	2
4	50311F0326X00	Flat Head Screw Long Fei:F3x5 NYLOK NI+Heat Treatment	F3x5 NYLOK NI+Heat Treatment	4
5	50311F0330X00	Round Head Screw Long Fei:P2x3 ISO+NYLON	P2x3 NI NYLOK	4
6	50311P0001X00	Price for Plastic Screw	HS6-75P 75mm	2
7	50322P0002X00	Plastic Nut Gin Lian:M6HW	10mmx6mm	2
8	5060900226X00	Mini PCIe Bracket CHYUAN-JYH	29x30x2.1mm SPCC t=1.0mm NI	1
9	6012200052X00	PE Zipper Bag #8	170x240mm, w/China RoHS Symbol	1
10	6012200053X00	PE Zipper Bag #3	100x70mm, w/China RoHS Symbol	2
11	60177A0464X00	(E)NIFE 200 Quick Reference Guide VER:A SIZE:A4	KRAMER	1
12	602DCD1049X00	(E)NIFE 200 DVD Driver VER:1.0	JCL	1
13	7800000078X00	DVI-I to VGA Adapter for NISE 104 ST:ADDH27B	DVI-I (24+5) Pin Male to VGA 15-pin Female	1

Ordering Information

The following information below provides ordering information for NIFE 200 series.

NIFE 200 (P/N: 10J70020000X0)

Intel® Atom™ processor J1900 Quad Core 2.0GHz fanless™ system

NIFE 200P2 (P/N: 10J70020001X0)

Intel® Atom™ processor J1900 Quad Core 2.0GHz fanless™ system

24V, 60W AC/DC power adapter w/ o power cord (P/N: 7400060054X00)

CHAPTER 1: PRODUCT INTRODUCTION

Overview



NIFE 200



NIFE 200P2

Key Features

- On-board Intel® Celeron® processor J1900 Quad Core 2.0GHz
- Dual independent display from DP and DVI-I
- 2 x Intel® I210AT GbE LAN ports support WoL, Teaming and PXE
- 3 x USB 2.0 & 1 x USB 3.0
- 2 x RS232/422/485
- 2 x Mini-PCIe socket for optional Wi-Fi/3.5G/4G LTE/Fieldbus modules
- Top access SD card socket
- Support -5 ~ 55 degree C operating temperature
- Typical 24V DC input with +/-20% range

Hardware Specifications

CPU Support

- On-board Intel® Celeron® processor J1900 Quad Core 2.0GHz
- Support Intel® Atom™ E3800 processor family from single core E3815, Dual Core E3825/E3826/E3827 and Quad Core E3845 with different SKUs

Main Memory

- 2 x DDR3L 1066/1333 SO-DIMM sockets, support 8GB

Display Option

- Dual independent display
 - DVI-I and DP

I/O Interface - Front

- ATX power on/off switch
- LEDs for HDD LED, Battery LEDs, Power LED, COM port TX/RX, 5 x programmable GPO LEDs
- 1 x External SD Card
- 1 x SIM card holder
- 2 x Intel® I210AT GbE LAN ports, support WoL, Teaming and PXE
- 1 x DP display output
- 1 x DVI-I display output
- 1 x USB 3.0 (900mA per each)
- 3 x USB 2.0 (500mA per each)
- 2 x RS232/422/485 support auto flow control
 - Jumper-free setting on RS232/422/485
 - Support 2.5KV isolation protection on COM1
- 1 x 3-pin DC input, Typical 24V DC input with +/-20% range

Storage Device

- 1 x 2.5" SSD/HDD (SATA 2.0) -- front accessible
- 1 x SD card (Data storage only)
- 1 x mSATA

Expansion Slot

- Two PCI Expansions (NIFE 200P2 only)
 - Add-on card length: 176mm max.
 - Power consumption: 10W/ slot max.
- 2 x Mini-PCIe sockets for optional Wi-Fi/3.5G/4G LTE/Fieldbus modules

Power Requirements

- Typical 24V DC input with +/-20% range
- 1 x optional 24V, 60W power adapter

Dimensions

- NIFE 200: 85mm (W) x 157mm (D) x 214mm (H)
- NIFE 200P2: 151mm (W) x 157mm (D) x 230mm (H)

Construction

- Aluminum and metal chassis with fanless design

Environment

- Operating temperature:
 - Ambient with air flow: -5°C to 55°C
 - (According to IEC60068-2-1, IEC60068-2-2, IEC60068-2-14)
- Storage temperature: -20°C to 80°C
- Relative humidity: 10% to 95% (non-condensing)

- Shock protection:
 - HDD: 20G, half sine, 11ms, IEC60068-2-27
 - SSD: 50G, half sine, 11ms, IEC60068-2-27
- Vibration protection w/SSD condition:
 - Random: 2Grms @ 5 ~ 500Hz, IEC60068-2-64
 - Sinusoidal: 2Grms @ 5 ~ 500Hz, IEC60068-2-6

Certifications

- CE Approval
 - EN61000-6-2
 - EN61000-6-4
- FCC Class A
- LVD
- UL60950

Support OS

- Windows 8, 32-bit/64-bit
- Windows Embedded Standard 8, 32-bit/64-bit
- Windows 7, 32-bit/64-bit
- Windows Embedded Standard 7, 32-bit/64-bit
- Linux Kernel version 3.8.0

Knowing Your NIFE 200/200P2

Front View

NIFE 200

NIFE 200P2

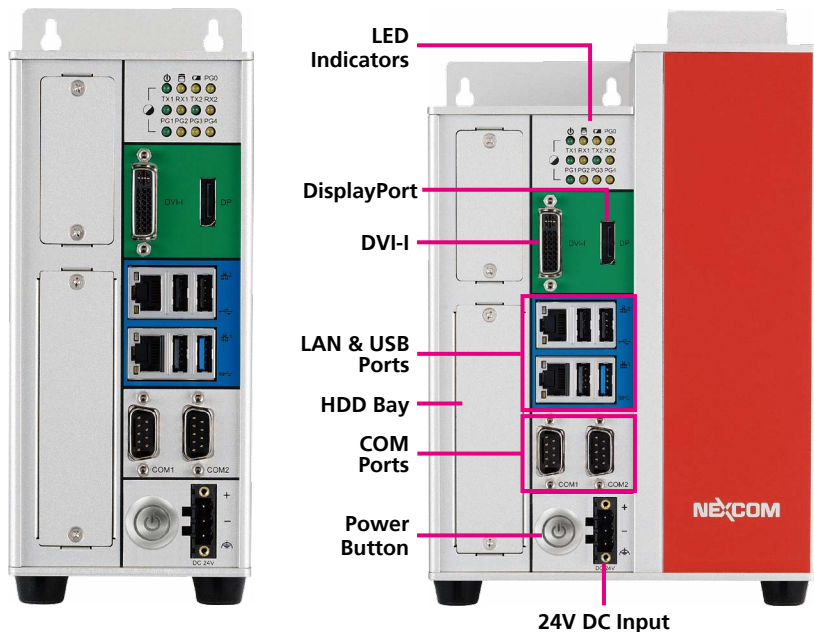

LED Indicators

Indicates the power, hard drive, battery, COM1/2 and GPO activity of the system.

DVI-I

Used to connect a digital LCD panel.

DisplayPort

Used to connect the system with display devices.

LAN Ports

Two LAN ports used to connect the system to a local area network.

USB Ports

USB 2.0 and USB 3.0 ports to connect the system with USB devices.

HDD Bay

A hard drive bay used to install 2.5" HDDs.

COM1 and COM2

Two DB9 ports used to connect RS232/422/485 compatible devices.

Power Button

Press to power-on or power-off the system.

24V DC Input

Used to plug a DC power cord.

Top View

NIFE 200P2 has the same top panel connectors as NIFE 200, with two additional PCI expansions.

NIFE 200

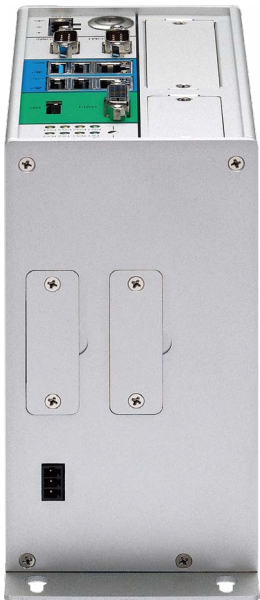

NIFE 200P2

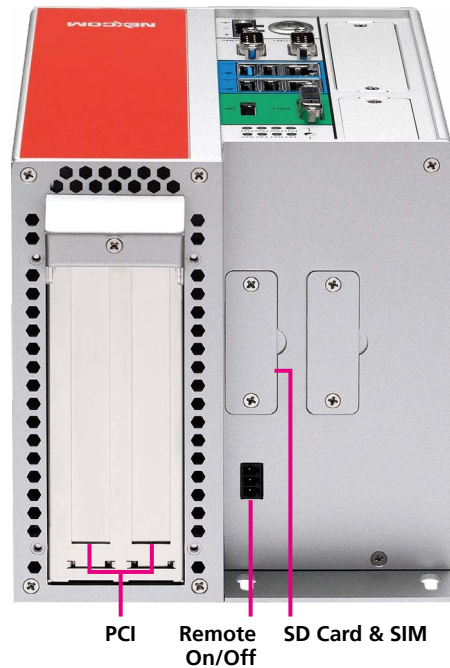

PCI Expansions

Two PCI expansion slots for add-on cards.

Remote On/Off Switch

Used to connect a remote to power on/off the system.

SD Card Slot

Used to insert a SD card.

SIM Slot

Used to insert a SIM card.

Mechanical Dimensions

NIFE 200

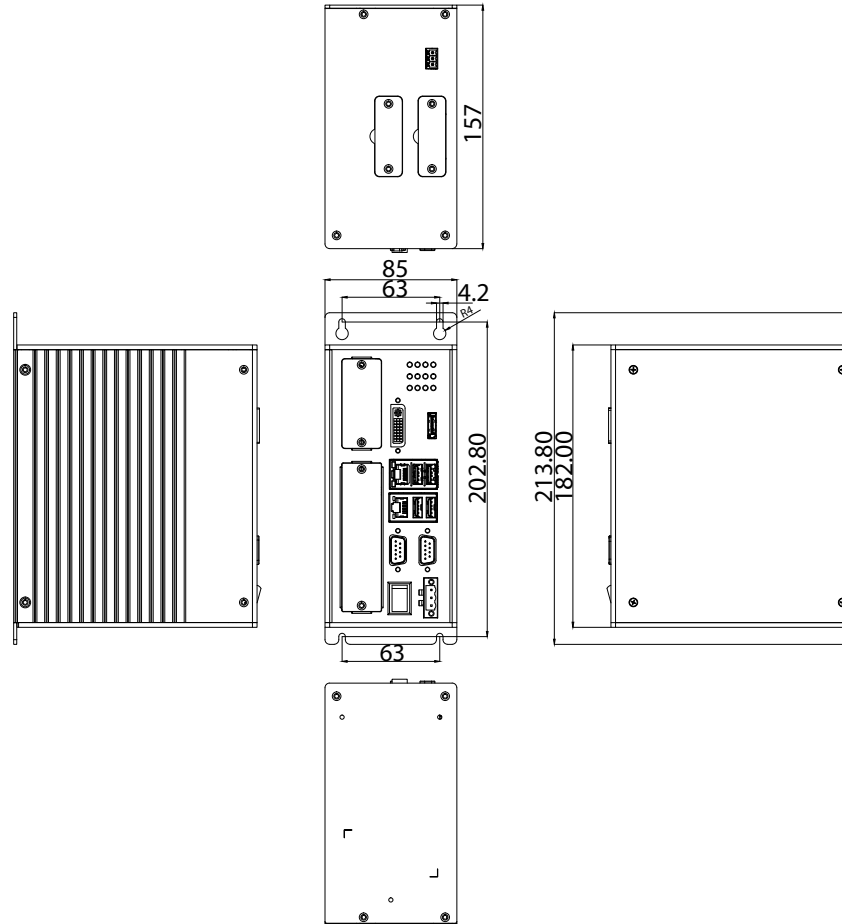

NIFE 200P2

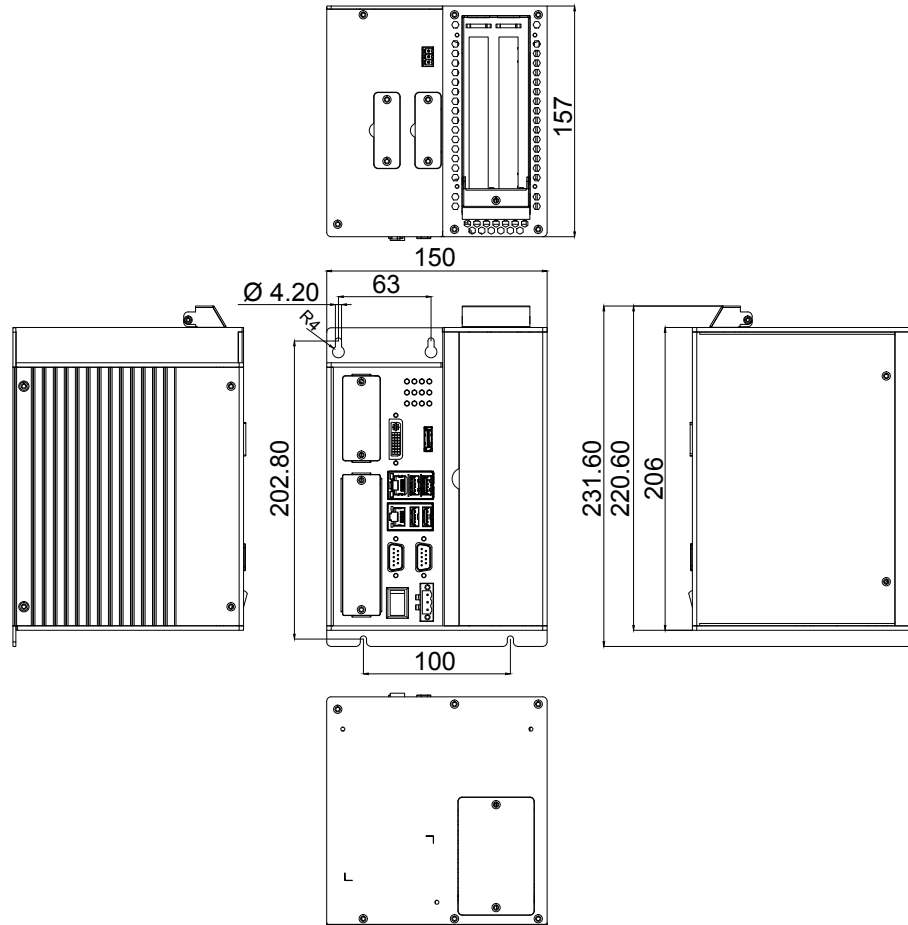

CHAPTER 2: JUMPERS AND CONNECTORS

This chapter describes how to set the jumpers and connectors on the NIFE 200 series motherboard.

Before You Begin

- Ensure you have a stable, clean working environment. Dust and dirt can get into components and cause a malfunction. Use containers to keep small components separated.
- Adequate lighting and proper tools can prevent you from accidentally damaging the internal components. Most of the procedures that follow require only a few simple tools, including the following:
 - A Philips screwdriver
 - A flat-tipped screwdriver
 - A set of jewelers screwdrivers
 - A grounding strap
 - An anti-static pad
- Using your fingers can disconnect most of the connections. It is recommended that you do not use needle-nosed pliers to disconnect connections as these can damage the soft metal or plastic parts of the connectors.
- Before working on internal components, make sure that the power is off. Ground yourself before touching any internal components, by touching a metal object. Static electricity can damage many of the electronic components. Humid environments tend to have less static electricity than

dry environments. A grounding strap is warranted whenever danger of static electricity exists.

Precautions

Computer components and electronic circuit boards can be damaged by discharges of static electricity. Working on computers that are still connected to a power supply can be extremely dangerous.

Follow the guidelines below to avoid damage to your computer or yourself:

- Always disconnect the unit from the power outlet whenever you are working inside the case.
- If possible, wear a grounded wrist strap when you are working inside the computer case. Alternatively, discharge any static electricity by touching the bare metal chassis of the unit case, or the bare metal body of any other grounded appliance.
- Hold electronic circuit boards by the edges only. Do not touch the components on the board unless it is necessary to do so. Don't flex or stress the circuit board.
- Leave all components inside the static-proof packaging that they shipped with until they are ready for installation.
- Use correct screws and do not over tighten screws.

Jumper Settings

A jumper is the simplest kind of electric switch. It consists of two metal pins and a cap. When setting the jumpers, ensure that the jumper caps are placed on the correct pins. When the jumper cap is placed on both pins, the jumper is short. If you remove the jumper cap, or place the jumper cap on just one pin, the jumper is open.

Refer to the illustrations below for examples of what the 2-pin and 3-pin jumpers look like when they are short (on) and open (off).

Two-Pin Jumpers: Open (Left) and Short (Right)

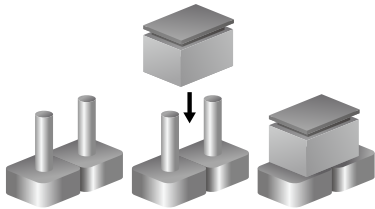

Three-Pin Jumpers: Pins 1 and 2 are Short

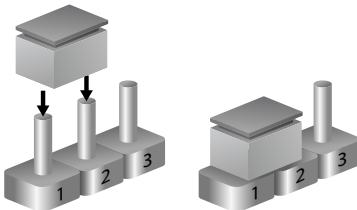

Locations of the Jumpers and Connectors for NIFB 200

The figure below is the top view of the NIFB 200 main board which is the main board used in NIFE 200 series. It shows the locations of the jumpers and connectors.

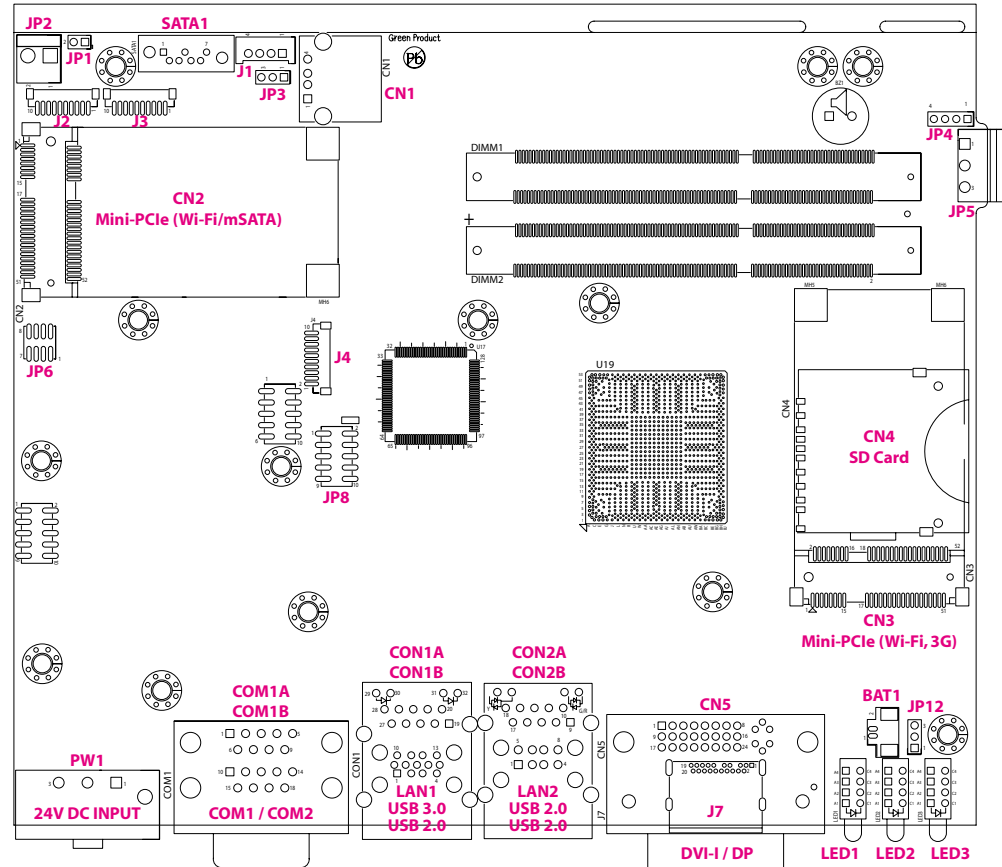

Jumpers

AT/ATX Mode Select

Connector type: 1x3 3-pin header, 2.0mm pitch

Connector location: JP3

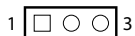

Pin	Definition
1	3VSB
2	AT/ATX_SEL
3	ATXBT_R

RTC Connector

Connector type: 1x3 3-pin header, 2.0mm pitch

Connector location: JP12

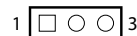

Pin	Definition
1	NC
2	RTC_TEST#
3	GND

Connector Pin Definitions

External I/O Interfaces - Front Panel

DVI-I Connector

Connector type: 24-pin D-Sub, 2.0mm-M-180 (DVI)

Connector location: CN5

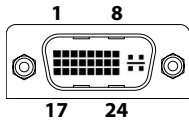

Pin	Definition	Pin	Definition
1	DVI1_DATA2_N_C	2	DVI1_DATA2_P_C
3	GND	4	NC
5	NC	6	DVI1_CTRL_CLK_C
7	DVI1_CTRL_DAT_C	8	VSYNC_VGA
9	DVI1_DATA1_N_C	10	DVI1_DATA1_P_C
11	GND	12	NC
13	NC	14	DVI1_PWR
15	GND	16	DVI1_HPD
17	DVI1_DATA0_N_C	18	DVI1_DATA0_P_C
19	GND	20	DDC_CLK_VGA_C
21	DDC_DATA_VGA_C	22	NC
23	DVI1_CLK_P_C	24	DVI1_CLK_N_C
C1	RED_VGA	C2	GREEN_VGA
C3	BLUE_VGA	C4	HSYNC_VGA
C5A	VGADET	C5B	GND

DisplayPort Connector

Connector type: DisplayPort

Connector location: J7

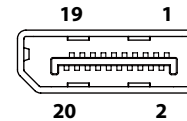

Pin	Definition	Pin	Definition
1	DP_DATA0_P_C	2	GND
3	DP_DATA0_N_C	4	DP_DATA1_P_C
5	GND	6	DP_DATA1_N_C
7	DP_DATA2_P_C	8	GND
9	DP_DATA2_N_C	10	DP_DATA3_P_C
11	GND	12	DP_DATA3_N_C
13	DPC_CONFIG1	14	DPC_CONFIG2
15	DPC_AUXP_C	16	GND
17	DPC_AUXN_C	18	DP_HPD_R
19	N21809347	20	HDMI_PWR

LAN1 and USB 3.0/USB 2.0 Ports

Connector type: RJ45 port with LEDs

USB 3.0 and USB 2.0 port, Type A

Connector location: CON1A (USB) and CON1B (LAN)

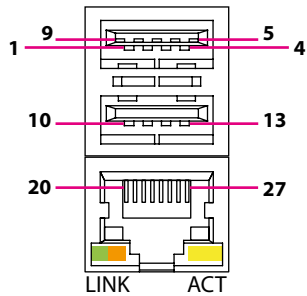

Act	Status
Flashing Yellow	Data activity
Off	No activity

Link	Status
Steady Green	1G network link
Steady Orange	100Mbps network link
Off	10Mbps or no link

USB

Pin	Definition	Pin	Definition
1	P5V_OC01_C	2	USB_ON_C
3	USB_OP_C	4	GND
5	USB3_RX0_N_C	6	USB3_RX0_P_C
7	GND	8	USB3_TX0_N_C
9	USB3_TX0_P_C	10	P5V_OC01_C
11	HUBUSB_DN4_C	12	HUBUSB_DP4_C
13	GND		

LAN

Pin	Definition	Pin	Definition
19	V1P5_LAN2	20	LAN2_MDI0P
21	LAN2_MDI0N	22	LAN2_MDI1P
23	LAN2_MDI1N	24	LAN2_MDI2P
25	LAN2_MDI2N	26	LAN2_MDI3P
27	LAN2_MDI3N	28	GND
29	LAN2_ACT_CON	30	LAN2_LED_ACT#
31	LAN2_100#_CON	32	LAN2_LINK1G#

LAN2 and USB 2.0 Ports

Connector type: RJ45 port with LEDs

USB 2.0 ports, Type A

Connector location: CON2A (USB) and CON2B (LAN)

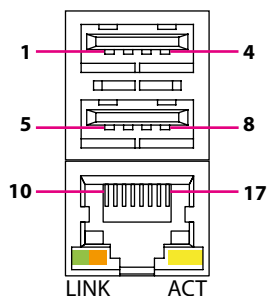

Act	Status
Flashing Yellow	Data activity
Off	No activity

Link	Status
Steady Green	1G network link
Steady Orange	100Mbps network link
Off	10Mbps or no link

USB

Pin	Definition	Pin	Definition
1	USB_OC12	2	DN1_C
3	DP1_C	4	GND
5	USB_OC12	6	DN2_C
7	DP2_C	8	GND

LAN

Pin	Definition	Pin	Definition
9	V1P5_LAN	10	LAN1_MDI0P
11	LAN1_MDI0N	12	LAN1_MDI1P
13	LAN1_MDI1N	14	LAN1_MDI2P
15	LAN1_MDI2N	16	LAN1_MDI3P
17	LAN1_MDI3N	18	GND
19	LAN1_LINK1G#	20	LAN1_100#_CON
21	LAN1_LED_ACT#	22	LAN1_ACT_CON

COM 1 Port (RS232/422/485)

Connector type: DB-9 port, 9-pin D-Sub
 Connector location: COM1A

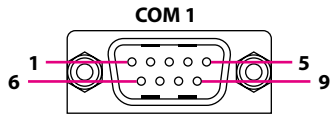

RS232		RS485		RS422	
Pin	Definition	Pin	Definition	Pin	Definition
1	SP1_DCD	1	SP1_DATA-	1	SP1_TX-
2	SP1_RXD	2	SP1_DATA+	2	SP1_TX+
3	SP1_TXD	3	NC	3	SP1_RX+
4	SP1_DTR	4	NC	4	SP1_RX-
5	GND	5	GND	5	GND
6	SP1_DSR	6	NC	6	SP1_RTS-
7	SP1_RTS	7	NC	7	SP1_RTS+
8	SP1_CTS	8	NC	8	SP1_CTS+
9	SP1_RI	9	NC	9	SP1_CTS-
MH2	REAR_GND	MH2	REAR_GND	MH2	REAR_GND
MH1	REAR_GND	MH1	REAR_GND	MH1	REAR_GND

COM 2 Port (RS232/422/485)

Connector type: DB-9 port, 9-pin D-Sub
 Connector location: COM1B

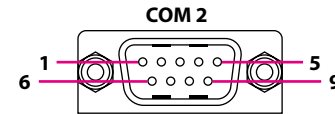

RS232		RS485		RS422	
Pin	Definition	Pin	Definition	Pin	Definition
1	SP2_DCD	1	SP2_DATA-	1	SP2_TX-
2	SP2_RXD	2	SP2_DATA+	2	SP2_TX+
3	SP2_TXD	3	NC	3	SP2_RX+
4	SP2_DTR	4	NC	4	SP2_RX-
5	GND	5	GND	5	GND
6	SP2_DSR	6	NC	6	SP2_RTS-
7	SP2_RTS	7	NC	7	SP2_RTS+
8	SP2_CTS	8	NC	8	SP2_CTS+
9	SP2_RI	9	NC	9	SP2_CTS-
MH2	REAR_GND	MH2	REAR_GND	MH2	REAR_GND
MH1	REAR_GND	MH1	REAR_GND	MH1	REAR_GND

24V DC Power Input

Connector type: Phoenix Contact 1x3 3-pin terminal block

Connector location: PW1

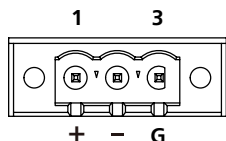

Pin	Definition
1	VIN_1
2	VIN_VSS
3	H3_GND

LED Indicators

Connector location: LED1, LED2 and LED3

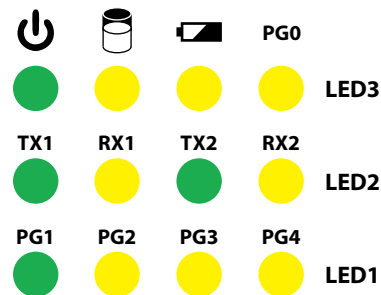

	Pin	Definition	Pin	Definition
LED1	A1	GPIO3_LED	C1	GPO_PR3
	A2	GPIO2_LED	C2	GPO_PR2
	A3	GPIO1_LED	C3	GPO_PR1
	A4	GPIO0_LED	C4	GPO_PR0
LED2	A1	COM2_RXLEDN	C1	COM2_RXLEDP
	A2	COM2_TXLEDN	C2	COM2_TXLEDP
	A3	COM1_RXLEDN	C3	COM1_RXLEDP
	A4	COM1_TXLEDN	C4	COM1_TXLEDP
LED3	A1	GPIO4_LED	C1	GPO_PR4
	A2	BAT_LED_N	C2	GND
	A3	HDD_LED_PWR	C3	HDD_LED_N
	A4	POWER_LED_PWR	C4	PWR_LED_N

Internal Connectors

SATA Connector

Connector type: Standard Serial ATA 7P (1.27mm, SATA-M-180)

Connector location: SATA1

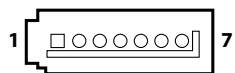

Pin	Definition	Pin	Definition
1	GND	2	S_TXP1
3	S_TXN1	4	GND
5	S_RXN1	6	S_RXP1
7	GND		

SATA Power Connector

Connector type: 1x4 4-pin header, 2.0mm pitch

Connector location: J1

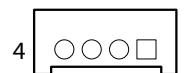

Pin	Definition
1	VCC12
2	GND
3	GND
4	VCC5

Internal USB Dongle Connector

Connector type: USB port

Connector location: CN1



Pin	Definition
1	USB_OC3
2	DN3_C
3	DP3_C
4	GND

SD Card Slot

Connector location: CN4

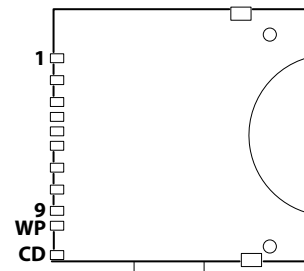

Pin	Definition	Pin	Definition
1	SD_D3	2	SD_CMD
3	GND	4	VSD
5	SD_CLK	6	GND
7	SD_D0	8	SD_D1
9	SD_D2	WP	SD_WP
CD	SD_DET		

Debug Card Connector

Connector type: 1x10 10-pin header, 1.0mm pitch

Connector location: J4



Pin	Definition	Pin	Definition
1	GND	2	PLTRST_3P3#
3	LPC_CLK0_DEBUG	4	LPC_FRAME#
5	LPC_AD3	6	LPC_AD2
7	LPC_AD1	8	LPC_ADO
9	VCC3	10	VCC3

Line-out Pin Header

Connector type: 1x4 4-pin header, 2.0mm pitch

Connector location: JP4

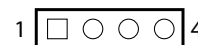

Pin	Definition
1	FRONT_LCI
2	AGND
3	EXLINEOUT_JD
4	FRONT_RCI

Power Connector

Connector type: 1x2 2-pin header, 3.96mm pitch
Connector location: JP2

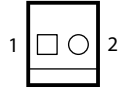

Pin	Definition
1	VCC12
2	GND

PS2 KB/MS Pin Header

Connector type: 2x4 8-pin header, 1.27mm pitch
Connector location: JP6

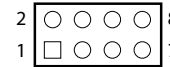

Pin	Definition	Pin	Definition
1	5VSB	2	5VSB
3	KDAT_R	4	MDAT_R
5	KCLK_R	6	MCLK_R
7	GND	8	GND

Remote Push Button Connector

Connector type: 1x3 3-pin terminal block, 3.81mm pitch
Connector location: JP5

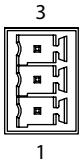

Pin	Definition
1	PBT_TR
2	GND
3	3VSB

System Reset Connector

Connector type: 1x2 2-pin header, 2.0mm pitch
Connector location: JP1



Pin	Definition
1	PM_RESET#_J
2	GND

Battery Connector

Connector type: 1x2 2-pin header, 2.0mm pitch

Connector location: BAT1

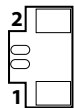

Pin	Definition
1	GND
2	VBAT

Internal COM3 Connector

Connector type: 1x10 10-pin header JST, 1.0mm pitch

Connector location: J2

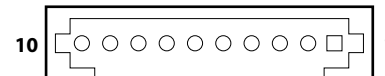

Pin	Definition	Pin	Definition
1	SP3_DCD	2	SP3_RXD
3	SP3_TXD	4	SP3_DTR
5	GND	6	SP3_DSR
7	SP3_RTS	8	SP3_CTS
9	SP3_RI	10	VCC5

Internal COM4 Connector

Connector type: 1x10 10-pin header JST, 1.0mm pitch

Connector location: J3

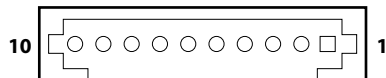

Pin	Definition	Pin	Definition
1	SP4_DCD	2	SP4_RXD
3	SP4_TXD	4	SP4_DTR
5	GND	6	SP4_DSR
7	SP4_RTS	8	SP4_CTS
9	SP4_RI	10	VCC12

Internal GPIO Pin Header

Connector type: 2x5 10-pin header, 2.0mm pitch

Connector location: JP8

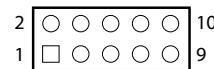

Pin	Definition	Pin	Definition
1	VCC5	2	GND
3	ICH_GPO0_OUT	4	ICH_GPIO_IN
5	ICH_GPO1_OUT	6	ICH_GPI1_IN
7	ICH_GPO2_OUT	8	ICH_GPI2_IN
9	ICH_GPO3_OUT	10	ICH_GPI3_IN

Mini-PCIe Connector

Connector location: CN3

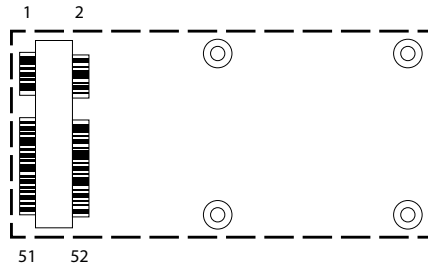

Pin	Definition	Pin	Definition
1	PCIE_WAKE#	2	3VSB_MINI2
3	NC	4	GND
5	NC	6	1V5
7	PCIE_CLKREQ2#	8	UIM_PWR
9	GND	10	UIM_DATA
11	PCIE_CLKN2	12	UIM_CLK
13	PCIE_CLKP2	14	UIM_RESET
15	GND	16	UIM_VCCP
17	NC	18	GND
19	NC	20	MINICARD2DIS#
21	GND	22	PLTRST_3P3#_CON
23	PCIE_RN2	24	3VSB_MINI2
25	PCIE_RP2	26	GND

Pin	Definition	Pin	Definition
27	GND	28	1V5
29	GND	30	SMB_CLK_CON
31	PCIE_TXN2	32	SMB_DATA_CON
33	PCIE_TXP2	34	GND
35	GND	36	MINI2USBN
37	GND	38	MINI2USBP
39	3VSB_MINI2	40	GND
41	3VSB_MINI2	42	NC
43	GND	44	NC
45	NC	46	NC
47	NC	48	1V5
49	NC	50	GND
51	NC	52	3VSB

Mini-PCIe Connector

Connector location: CN2

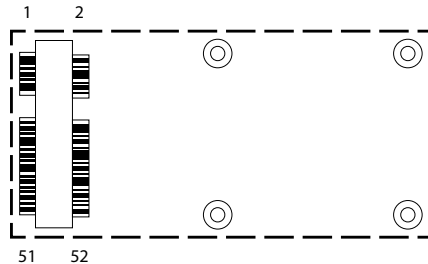

Pin	Definition	Pin	Definition
1	PCIE_WAKE#	2	3VSB_MINI1
3	NC	4	GND
5	NC	6	1V5
7	PCIE_CLKREQ3#	8	NC
9	GND	10	NC
11	HUB_CLKN3_R	12	NC
13	HUB_CLKP3_R	14	NC
15	GND	16	NC
17	NC	18	GND
19	NC	20	MINICARD1DIS#
21	GND	22	PLTRST_3P3#_CON
23	PCIE_mSATA_RXP_R	24	3VSB_MINI1
25	PCIE_mSATA_RXN_R	26	GND

Pin	Definition	Pin	Definition
27	GND	28	1V5_1
29	GND	30	SMB_CLK_CON
31	PCIE_mSATA_TXN_R	32	SMB_DATA_CON
33	PCIE_mSATA_TXP_R	34	GND
35	GND	36	DN2
37	GND	38	DP2
39	3VSB_MINI1	40	GND
41	3VSB_MINI1	42	NC
43	GND	44	NC
45	NC	46	NC
47	NC	48	1V5_1
49	NC	50	GND
51	NC	52	3VSB_MINI1

CHAPTER 3: SYSTEM SETUP

Installing a SO-DIMM Memory Module

1. Place the NIFE 200P2 system on a flat surface to prepare for installation.
2. Locate the four screws on the side of the chassis.



3. Remove the four screws and gently lift up the side cover.



4. Locate the memory module sockets.

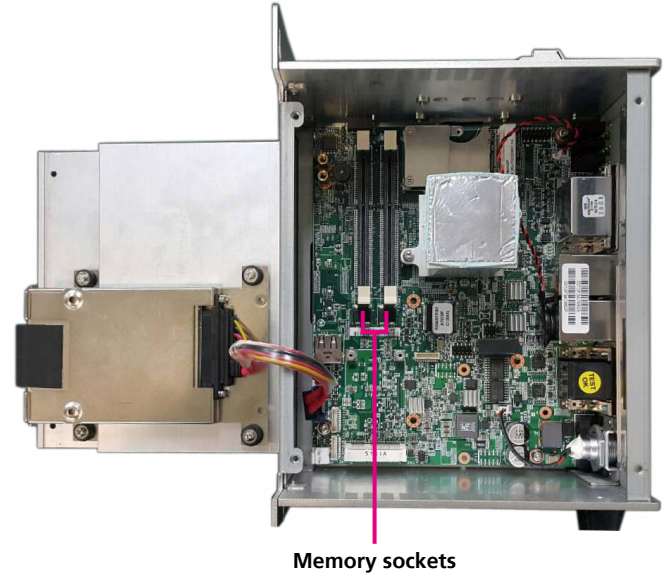

5. Insert the memory module into the socket.



6. Ensure the memory module is secured properly into the socket.



Installing a 2.5" SATA HDD

1. Locate the HDD drive bay cover on the front panel.



2. Remove the screws on the HDD drive bay cover.



3. Pull out the HDD bracket by pulling the tape.



4. Install the 2.5" HDD into the bracket and secure it with screws.

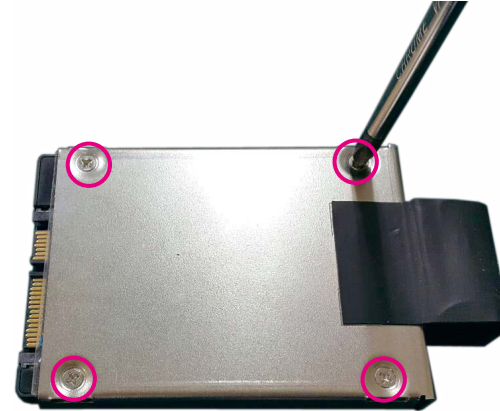

5. Place the HDD bracket back to its original location.



6. Secure the HDD drive bay cover with screws.



Installing a Mini-PCle Module (Half-Size)

1. Locate the mini-PCle slot on the board.

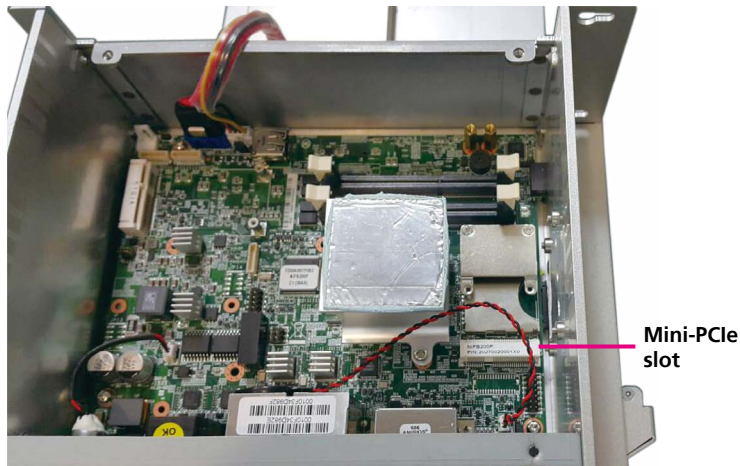

2. Remove the mini-PCle bracket from the board.

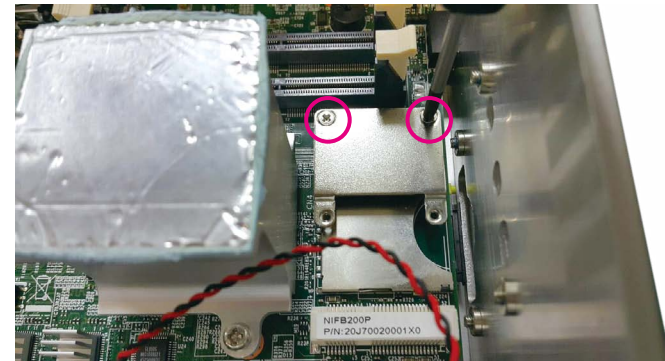

3. Screw the mini-PCIe bracket to the mini-PCIe module.



4. Insert the mini-PCIe module into the mini-PCIe slot at a 45 degree angle until the gold-plated connector on the edge of the module completely disappears into the slot.



5. Push the module down and secure it with screws.



Installing a Mini-PCle Module (Full-Size)

1. Locate the mini-PCle slot on the board and remove the mini-PCle bracket.

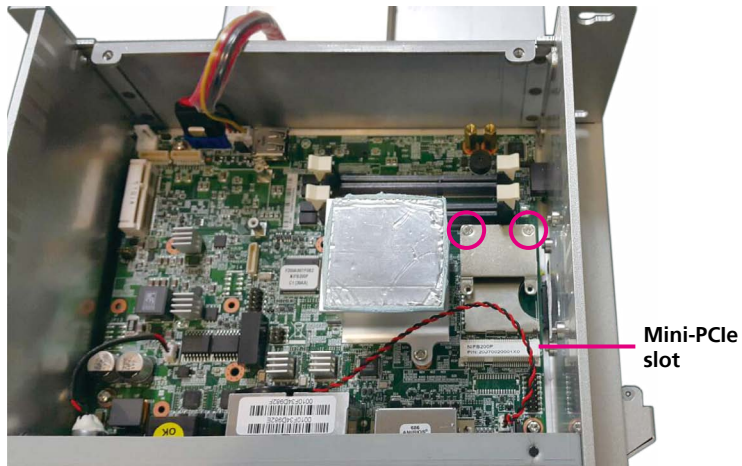

2-1. Insert the mini-PCle module into the mini-PCle slot at a 45 degree angle until the gold-plated connector on the edge of the module completely disappears into the slot.



2-2. Secure the module with screws.

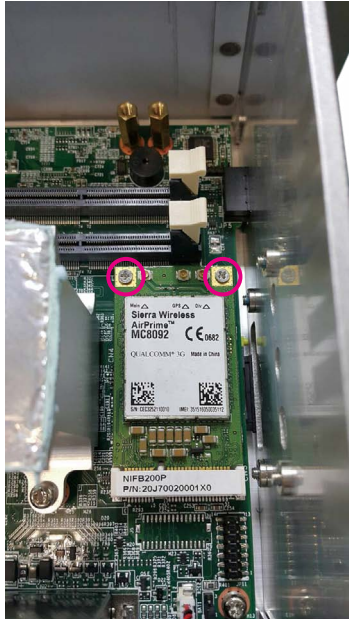

Installing a SD Card or SIM Card

SD Card Installation Instructions

1. Locate the SIM/SD card cover on the top of NIFE 200P2 and loosen the screws on the cover.
2. Remove the cover.

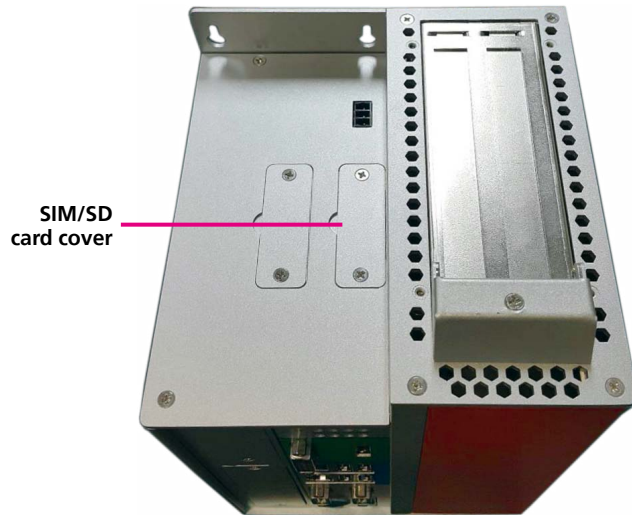

3. Insert the SD card into the SD card socket.



4. Ensure the SD card is correctly secured in position.



5. Press down the SD card until it is fixed into the socket.



SIM Card Installation Instructions

6. Locate the SIM Card socket on the top of NIFE 200P2 and press the yellow button gently to retrieve the SIM card holder.

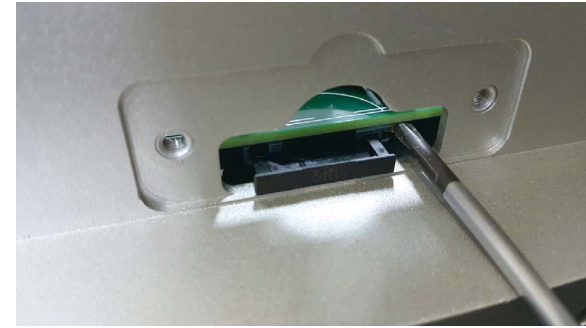

7. Place the SIM card into the holder.



8. Insert the SIM card holder back to its original position.



Installing an Antenna or Audio Cable

Antenna Installation Instructions

1. Remove the side cover of the chassis first.

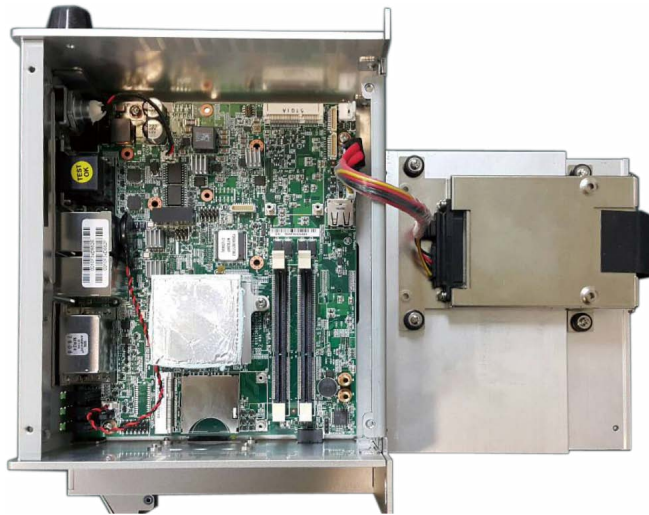

2. Remove the antenna hole cover located on the top of NIFE 200P2.
(2x Antenna Holes, 1x Audio Cable Hole)

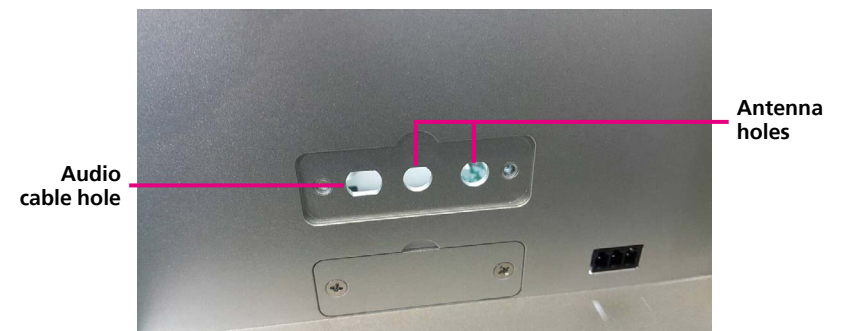

3. Separate the 2 rings (ring 1 and ring 2) from the antenna jack.



4. Insert the antenna jack through the antenna hole, and then install ring 1 and ring 2 onto the antenna jack.

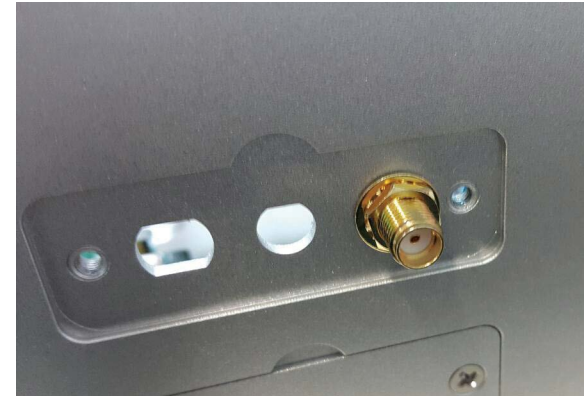

5. Attach the antenna cable end onto the 3G or Wi-Fi mini-PCle module.



Audio Cable Installation Instructions

6. Separate ring 3 from the audio cable.

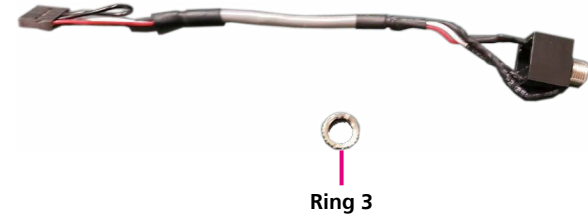

7. Insert the audio cable through the audio cable hole, and then install ring 3 onto the audio jack.



8. Attach the audio cable end to the JP4 connector, which is the audio pin header for the NIFE 200 series.

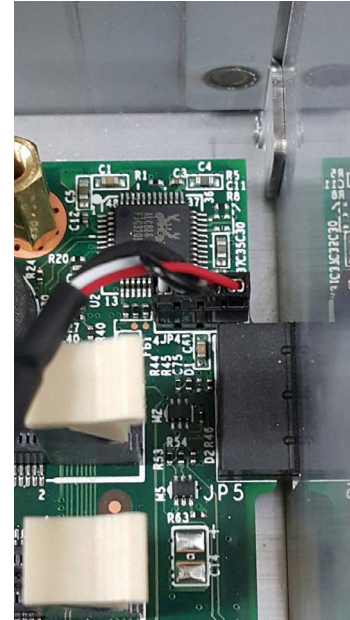

Removing the Side Cover

1. Remove the screw circled below, located on the top of NIFE 200P2.

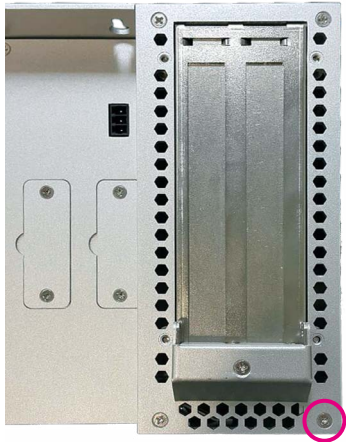

2. Remove the screw circled below, located on the bottom of NIFE 200P2.



3. Locate the two screws on the side cover of NIFE 200P2.

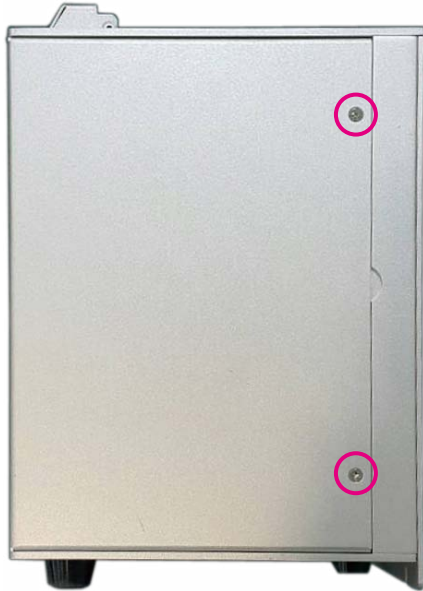

4. Remove the screws and gently lift up the side cover.



Installing a PCI or PCIe Card



Remove the side cover first.
These steps only apply to NIFE 200P2 and NIFE 200P2E

1. Locate and remove the screw on the PCI bracket cover.

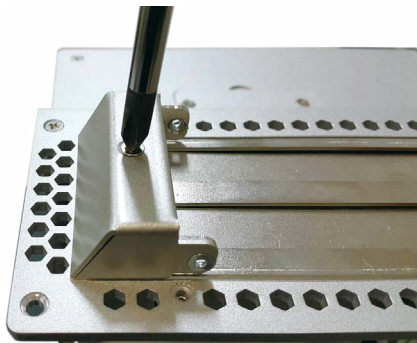
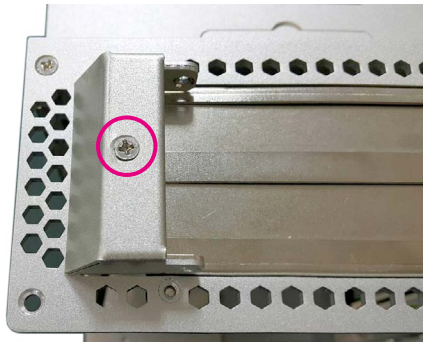

2. Lift up the bracket cover and remove the PCI bracket.

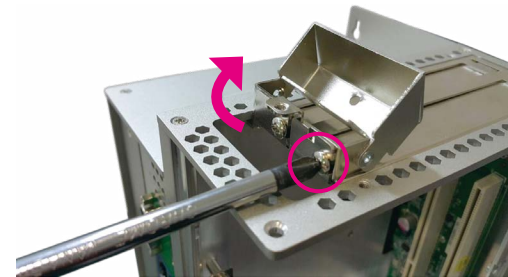

3. Install the PCI or PCIe card into the slot.

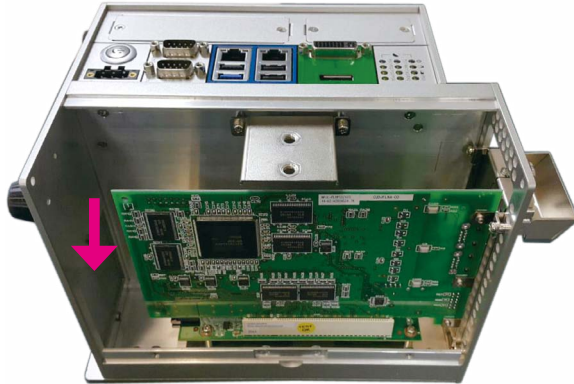

4. Remove the PCI card holder kit.



5. Secure the screw to the PCI bracket to fix the PCI or PCIe card.

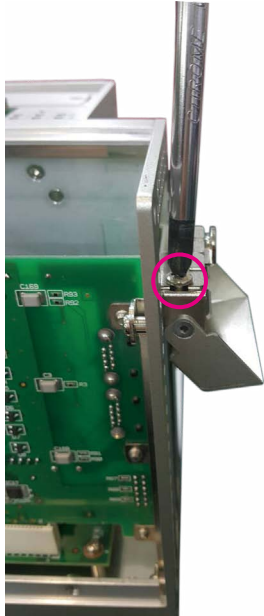

6. Install the plastic screw into the PCI holder kit.

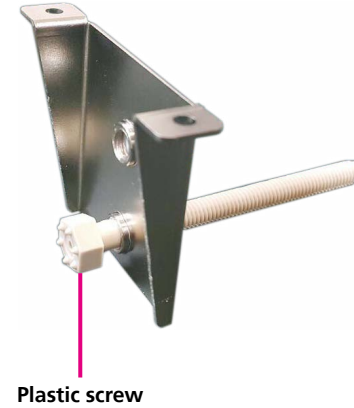

7. Install the plastic nut into the PCI holder kit.

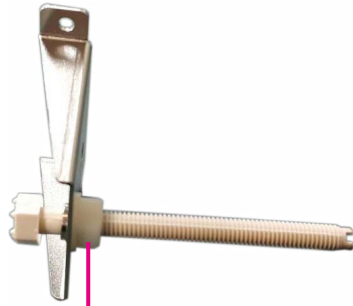

Plastic nut

8. Secure the PCI holder kit with screws to fix the PCI or PCIe card.

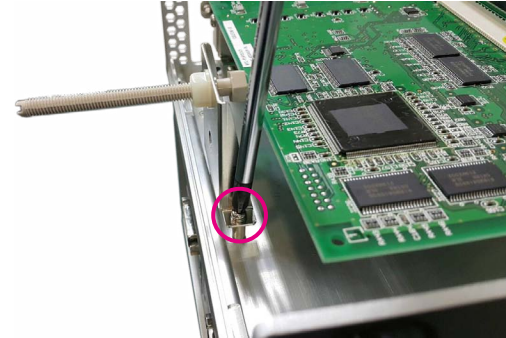

9. Install the plastic screw until it touches the edge of PCI or PCIe card, and fix the plastic nut. Do not squeeze or apply too much force down on the PCI or PCIe card since the purpose of having the plastic screw is to help position the PCI card.

(Check if the plastic screw is fixed correctly to the edge of the PCI or PCIe card. There should be three positioning dots on each side.)

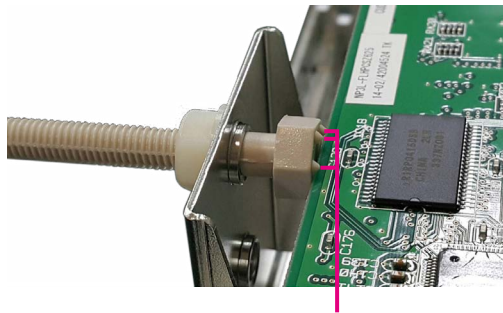

Positioning dots



10. Cut off the extra length of the plastic screw. The cutting position should be the same height as the edge of the plastic nut.

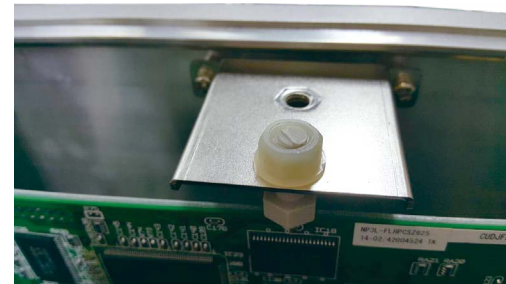
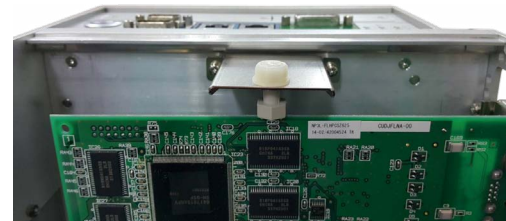
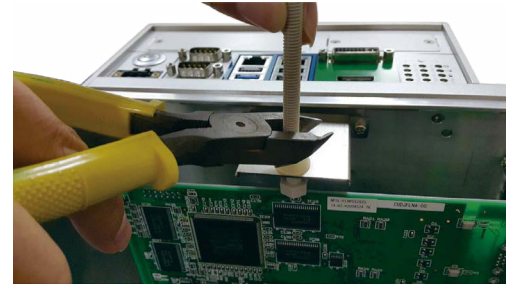

11. Please do a final check to ensure that the PCI or PCIe card is firmly in place and not installed crooked.



CHAPTER 4: BIOS SETUP

This chapter describes how to use the BIOS setup program for the NIFE 200 series. The BIOS screens provided in this chapter are for reference only and may change if the BIOS is updated in the future.

To check for the latest updates and revisions, visit the NEXCOM website at www.nexcom.com.tw.

About BIOS Setup

The BIOS (Basic Input and Output System) Setup program is a menu driven utility that enables you to make changes to the system configuration and tailor your system to suit your individual work needs. It is a ROM-based configuration utility that displays the system's configuration status and provides you with a tool to set system parameters.

These parameters are stored in non-volatile battery-backed-up CMOS RAM that saves this information even when the power is turned off. When the system is turned back on, the system is configured with the values found in CMOS.

With easy-to-use pull down menus, you can configure items such as:

- Hard drives, diskette drives, and peripherals
- Video display type and display options
- Password protection from unauthorized use
- Power management features

The settings made in the setup program affect how the computer performs. It is important, therefore, first to try to understand all the setup options, and second, to make settings appropriate for the way you use the computer.

When to Configure the BIOS

- This program should be executed under the following conditions:
 - When changing the system configuration
 - When a configuration error is detected by the system and you are prompted to make changes to the setup program
 - When resetting the system clock
 - When redefining the communication ports to prevent any conflicts
 - When making changes to the Power Management configuration
 - When changing the password or making other changes to the security setup

Normally, CMOS setup is needed when the system hardware is not consistent with the information contained in the CMOS RAM, whenever the CMOS RAM has lost power, or the system features need to be changed.

Default Configuration

Most of the configuration settings are either predefined according to the Load Optimal Defaults settings which are stored in the BIOS or are automatically detected and configured without requiring any actions. There are a few settings that you may need to change depending on your system configuration.

Entering Setup











When the system is powered on, the BIOS will enter the Power-On Self Test (POST) routines. These routines perform various diagnostic checks; if an error is encountered, the error will be reported in one of two different ways:

- If the error occurs before the display device is initialized, a series of beeps will be transmitted.
- If the error occurs after the display device is initialized, the screen will display the error message.

Powering on the computer and immediately pressing allows you to enter Setup.

Press the  key to enter Setup:

Legends

Key	Function
	Moves the highlight left or right to select a menu.
	Moves the highlight up or down between sub-menus or fields.
	Exits the BIOS Setup Utility.
	Scrolls forward through the values or options of the highlighted field.
	Scrolls backward through the values or options of the highlighted field.
	Selects a field.
	Displays General Help.
	Load previous values.
	Load optimized default values.
	Saves and exits the Setup program.
	Press <Enter> to enter the highlighted sub-menu

Scroll Bar

When a scroll bar appears to the right of the setup screen, it indicates that there are more available fields not shown on the screen. Use the up and down arrow keys to scroll through all the available fields.

Submenu

When “▶” appears on the left of a particular field, it indicates that a submenu which contains additional options are available for that field. To display the submenu, move the highlight to that field and press  .

BIOS Setup Utility

Once you enter the AMI BIOS Setup Utility, the Main Menu will appear on the screen. The main menu allows you to select from several setup functions and one exit. Use arrow keys to select among the items and press  to accept or enter the submenu.

Main

The Main menu is the first screen that you will see when you enter the BIOS Setup Utility.

System Date

The date format is <day>, <month>, <date>, <year>. Day displays a day, from Monday to Sunday. Month displays the month, from January to December. Date displays the date, from 1 to 31. Year displays the year, from 1999 to 2099.

System Time

The time format is <hour>, <minute>, <second>. The time is based on the 24-hour military-time clock. For example, 1 p.m. is 13:00:00. Hour displays hours from 00 to 23. Minute displays minutes from 00 to 59. Second displays seconds from 00 to 59.



The screenshot shows the Aptio Setup Utility Main menu. The title bar reads "Aptio Setup Utility - Copyright (C) 2015 American Megatrends, Inc." The menu has tabs for Main, Advanced, Chipset, Security, Boot, and Save & Exit. The Main menu is selected, showing the following information:

BIOS Information		Set the Date. Use Tab to switch between Date elements.
BIOS Vendor	American Megatrends	
Core Version	5.009	
Compliancy	UEFI 2.3; PI 1.2	
Project Version	F200A009 x64	
Build Date and Time	06/16/2015 09:43:50	
CPU Configuration		---: Select Screen ↑↓: Select Item Enter: Select +/-: Change Opt. F1: General Help F2: Previous Values F3: Optimized Defaults F4: Save & Exit ESC: Exit
Microcode Patch	815	
Memory Information		
Total Memory	8192 MB	
GOP Information		
Intel(R) GOP Driver	[N/A]	
System Date	[Thu 11/26/2015]	
System Time	[13:15:49]	

At the bottom of the screen, it says "Version 2.17.1249. Copyright (C) 2015 American Megatrends, Inc."

Advanced

The Advanced menu allows you to configure your system for basic operation. Some entries are defaults required by the system board, while others, if enabled, will improve the performance of your system or let you set some features according to your preference.



Setting incorrect field values may cause the system to malfunction.

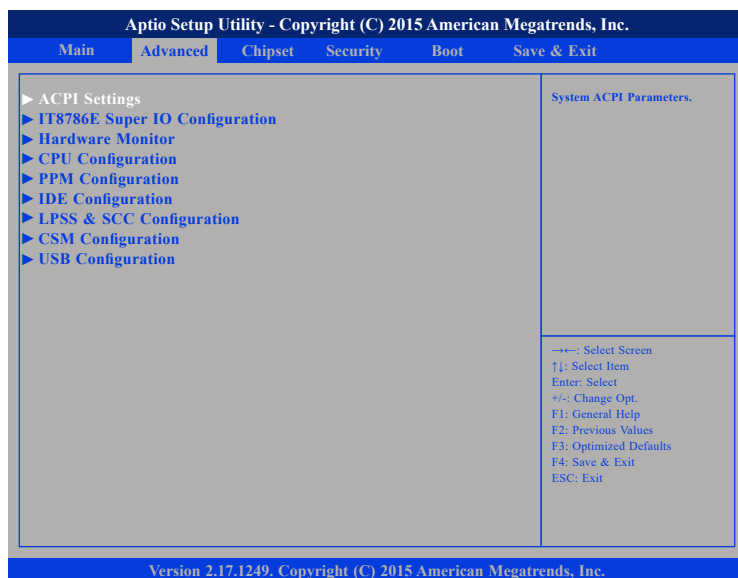

ACPI Settings

This section is used to configure ACPI Settings.

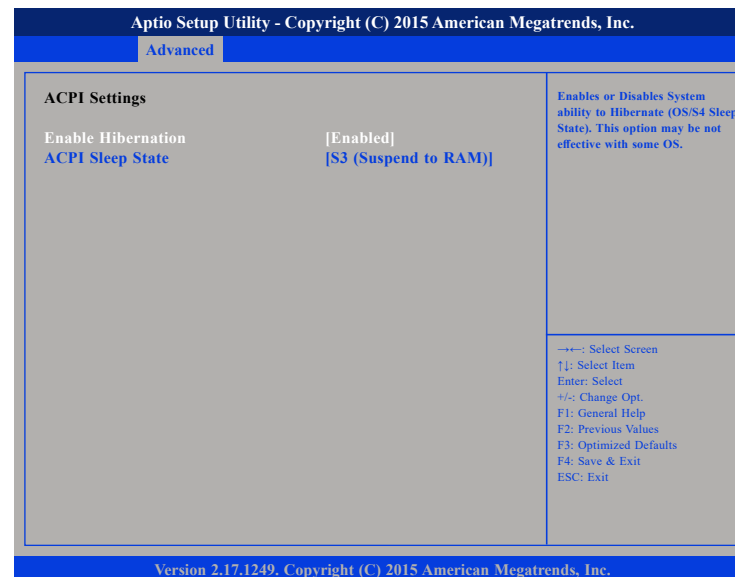

Enable Hibernation

Enables or disables system ability to hibernate (OS/S4 Sleep State). This option may not be effective with some OS.

ACPI Sleep State

Select the highest ACPI sleep state the system will enter when the suspend button is pressed. The options are Suspend Disabled and S3 (Suspend to RAM).

IT8786E Super IO Configuration

This section is used to configure the serial ports.



Super IO Chip

Displays the Super I/O chip used on the board.

Serial Port 1 Configuration

This section is used to configure serial port 1.

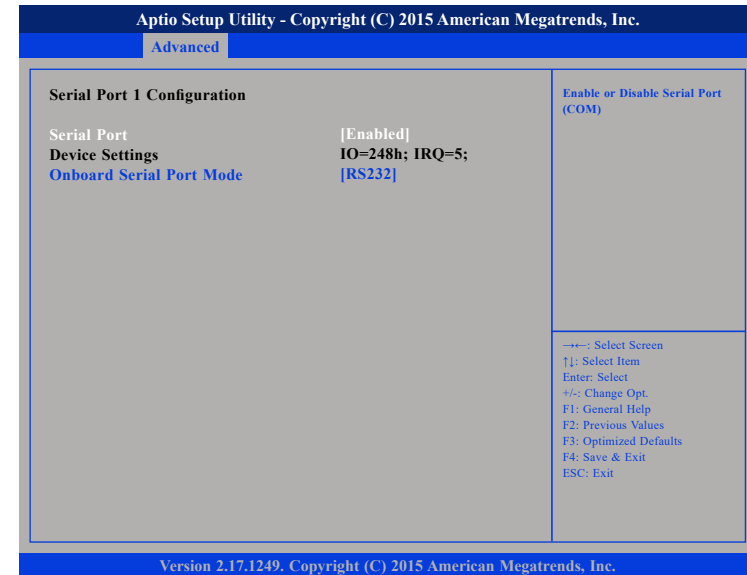

Serial Port

Enables or disables the serial port.

Onboard Serial Port Mode

Select this to change the serial port mode to RS232, RS422, RS485 or RS485 Auto.

Hardware Monitor

This section is used to monitor hardware status such as temperature, fan speed and voltages.

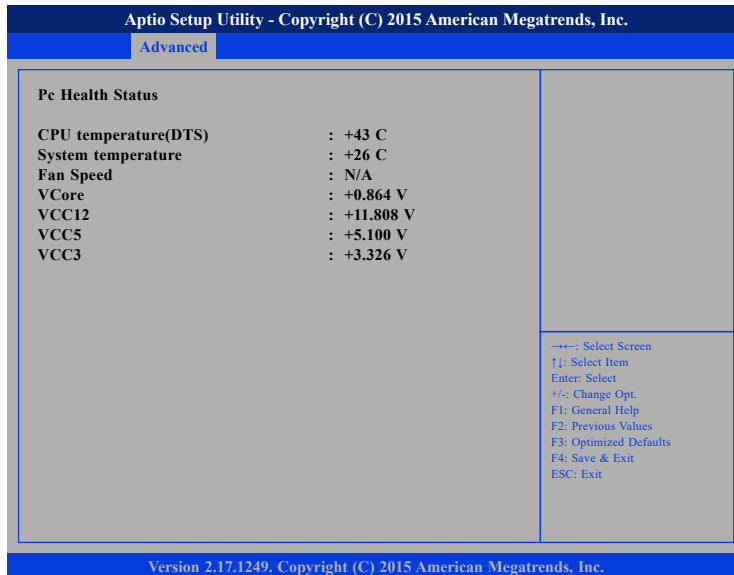

VCore

Detects and displays the Vcore CPU voltage.

VCC12

Detects and displays 12V voltage.

VCC5

Detects and displays 5V voltage.

VCC3

Detects and displays 3.3V voltage.

CPU Temperature

Detects and displays the current CPU temperature.

System Temperature

Detects and displays the current system temperature.

Fan Speed

Detects and displays the fan speed.

CPU Configuration

This section is used to configure the CPU.



Active Processor Cores

Select the number of cores to enable in each processor package.

Limit CPUID Maximum

The CPUID instruction of some newer CPUs will return a value greater than 3. The default is Disabled because this problem does not exist in the Windows series operating systems. If you are using an operating system other than Windows, this problem may occur. To avoid this problem, enable this field to limit the return value to 3 or lesser than 3.

Execute Disable Bit

When this field is set to Disabled, it will force the XD feature flag to always return to 0. XD can prevent certain classes of malicious buffer overflow attacks when combined with a supporting OS (Windows Server 2003 SP1, Windows XP SP2, SuSE Linux 9.2, RedHat Enterprise 3 Update 3).

Intel® Virtualization Technology

Enables or disables Intel® Virtualization technology.

PPM Configuration

This section is used to configure the Processor Power Management (PPM) configuration.



EIST

Enables or disables Intel® SpeedStep.

IDE Configuration

This section is used to configure the SATA drives.



Serial-ATA (SATA)

Enables or disables the SATA device.

Serial-ATA Port 0 and Serial-ATA Port 1

Enables or disables SATA port 0 and SATA port 1.

SATA Port0 Hotplug and SATA Port1 Hotplug

Enables or disables hotplug support on SATA port 0 and SATA port 1.

SATA Mode

Configures the SATA as IDE or AHCI mode.

- IDE This option configures the Serial ATA drives as Parallel ATA physical storage device.
- AHCI This option configures the Serial ATA drives to use AHCI (Advanced Host Controller Interface). AHCI allows the storage driver to enable the advanced Serial ATA features which will increase storage performance.

LPSS & SCC Configuration

This section is used to configure LPSS and SCC settings.



LPSS & SCC Devices Mode

Selects the LPSS and SCC device mode as ACPI mode or PCI mode.

SCC eMMC Support

Enables or disables SCC eMMC support.

SCC SD Card Support

Enables or disables SCC SD card support.

DDR50 Support for SDCard

Enables or disables DDR50 support for SD card.

CSM Configuration

This section is used to configure the compatibility support module features.

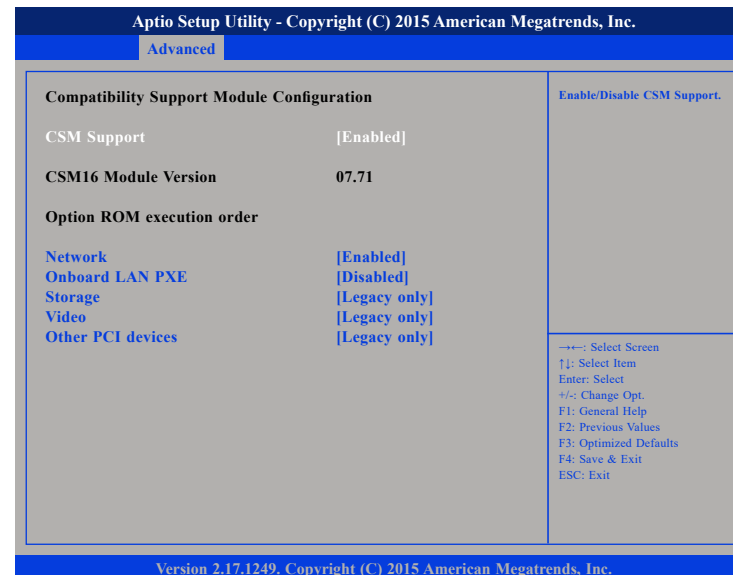

CSM Support

Enables or disables CSM support.

Network

Controls the execution of UEFI and legacy PXE OpROM.

Onboard LAN PXE

Enables or disables onboard LAN PXE ROM.

Storage

Controls the execution of UEFI and legacy storage OpROM.

USB Configuration

This section is used to configure the USB.



Legacy USB Support

Enable Enables Legacy USB.

Auto Disables support for Legacy when no USB devices are connected.

Disable Keeps USB devices available only for EFI applications.

USB3.0 Support

Enables or disables USB 3.0 controller support.

XHCI Hand-off and EHCI Hand-off

This is a workaround for OSs that does not support XHCI hand-off and EHCI Hand-off. The XHCI and EHCI ownership change should be claimed by the XHCI and EHCI driver respectively.

Chipset

This section gives you functions to configure the system based on the specific features of the chipset. The chipset manages bus speeds and access to system memory resources.



High Precision Timer

Enables or disables the high precision event timer.

Restore AC Power Loss

Select the AC power state when power is re-applied after a power failure.

Azalia HD Audio



Azalia

Control detection of the Azalia device.

Disabled Azalia will be unconditionally disabled.
 Enabled Azalia will be unconditionally enabled.

Azalia HDMI Codec

Enables or disables internal HDMI codec for Azalia.

USB Configuration



USB 2.0(EHCI) Support

Enables or disables the Enhanced Host Controller Interface (USB 2.0), one EHCI controller must always be enabled.

USB RMH Mode

Enables or disables PCH USB rate matching hubs mode.

USB EHCI Debug

Enables or disables PCH EHCI debug capability.

PCI Express Configuration

Aptio Setup Utility - Copyright (C) 2015 American Megatrends, Inc.

Chipset

PCI Express Configuration

PCI Express Port 0	[Enabled]
PCI Express Port 1	[Enabled]
PCI Express Port 2	[Enabled]
PCI Express Port 3	[Enabled]

Enable or Disable the PCI Express Port 0 in the Chipset.

←→: Select Screen
 ↑↓: Select Item
 Enter: Select
 +/-: Change Opt.
 F1: General Help
 F2: Previous Values
 F3: Optimized Defaults
 F4: Save & Exit
 ESC: Exit

Version 2.17.1249. Copyright (C) 2015 American Megatrends, Inc.

PCI Express Port 0 to PCI Express Port 3

Enables or disables the PCI Express ports 0 to 3 on the chipset.

Security

Aptio Setup Utility - Copyright (C) 2015 American Megatrends, Inc.

Main Advanced Chipset **Security** Boot Save & Exit

Password Description

Set Administrator Password

If ONLY the Administrator's password is set, then this only limits access to Setup and is only asked for when entering Setup.
 If ONLY the User's password is set, then this is a power on password and must be entered to boot or enter Setup. In Setup the User Will have Administrator rights.
 The password length must be in the following range:
 Minimum length 3
 Maximum length 20

Administrator Password
 User Password

←→: Select Screen
 ↑↓: Select Item
 Enter: Select
 +/-: Change Opt.
 F1: General Help
 F2: Previous Values
 F3: Optimized Defaults
 F4: Save & Exit
 ESC: Exit

Version 2.17.1249. Copyright (C) 2015 American Megatrends, Inc.

Administrator Password

Select this to reconfigure the administrator's password.

User Password

Select this to reconfigure the user's password.

Boot

Aptio Setup Utility - Copyright (C) 2015 American Megatrends, Inc.					
Main	Advanced	Chipset	Security	Boot	Save & Exit
Boot Configuration		Select the keyboard NumLock state			
Bootup NumLock State	[On]				
Fast Boot	[Disabled]				
Boot Option Priorities					
Boot Option #1	[UEFI: Built-in EFI . . .]				
		→←: Select Screen ↑↓: Select Item Enter: Select +/-: Change Opt. F1: General Help F2: Previous Values F3: Optimized Defaults F4: Save & Exit ESC: Exit			
Version 2.17.1249. Copyright (C) 2015 American Megatrends, Inc.					

Bootup NumLock State

This allows you to determine the default state of the numeric keypad. By default, the system boots up with NumLock on wherein the function of the numeric keypad is the number keys. When set to Off, the function of the numeric keypad is the arrow keys.

Fast Boot

When enabled, the BIOS will shorten or skip some check items during POST. This will decrease the time needed to boot the system.

Boot Option Priorities

Adjust the boot sequence of the system. Boot Option #1 is the first boot device that the system will boot from, next will be #2 and so forth.

Save & Exit

Aptio Setup Utility - Copyright (C) 2015 American Megatrends, Inc.					
Main	Advanced	Chipset	Security	Boot	Save & Exit
Save Changes and Reset		Reset the system after saving the changes.			
Discard Changes and Reset					
Restore Defaults					
		→←: Select Screen ↑↓: Select Item Enter: Select +/-: Change Opt. F1: General Help F2: Previous Values F3: Optimized Defaults F4: Save & Exit ESC: Exit			
Version 2.17.1249. Copyright (C) 2015 American Megatrends, Inc.					

Save Changes and Reset

To save the changes and reset, select this field then press <Enter>. A dialog box will appear. Confirm by selecting Yes.

Discard Changes and Reset

To exit the Setup utility without saving the changes, select this field then press <Enter>. You may be prompted to confirm again before exiting.

Restore Defaults

To restore the BIOS to default settings, select this field then press <Enter>. A dialog box will appear. Confirm by selecting Yes.

APPENDIX A: POWER CONSUMPTION

Power Consumption Management

Purpose

The purpose of the power consumption test is to verify the power dissipation of system, and the loading of power supply.

Test Equipment

PROVA CM-07 AC/DC CLAMP METER

Device Under Test

DUT: sys#1/

Test Procedure

1. Power up the DUT, boot into Windows 7 x32 Professional.
2. Entering standby mode (HDD power down).
3. Measure the power consumption and record it.
4. Run Burn-in test program to apply 100% full loading.
5. Measure the power consumption and record it.

Test Data

	Sys #1
	+24V
Full-Loading Mode	2.1A
Total	50.4W
Standby S3 Mode	0.4A
Total	9.8W

APPENDIX B: GPIO PROGRAMMING GUIDE

GPIO (General Purpose Input/Output) pins are provided for custom system design. This appendix provides definitions and its default setting for the ten GPIO pins in the NIFE 200 series. The pin definition is shown in the following table:

Pin	GPIO Mode	PowerOn Default	Address	Pin	GPIO Mode	PowerOn Default	Address
1	VCC	-	-	2	GND	-	-
3	GPO0	Low	A03h (Bit6)	4	GPIO	Low	A03h (Bit1)
5	GPO1	Low	A02h (Bit5)	6	GPI1	Low	A05h (Bit5)
7	GPO2	Low	A07h (Bit0)	8	GPI2	Low	A05h (Bit4)
9	GPO3	Low	A07h (Bit1)	10	GPI3	Low	A00h (Bit1)

Control the GPO 0/1/2/3 level from I/O port A03h bit6/ A02h bit5 A07h bit0/ A07h bit1.
The bit is Set/Clear indicated output High/Low.

GPIO programming sample code

```
#define GPO0          (0x01 << 6)
#define GPO1          (0x01 << 5)
#define GPO2          (0x01 << 0)
#define GPO3          (0x01 << 1)

#define GPO0_HI       outportb(0xA03, GPO0)
#define GPO0_LO       outportb(0xA03, 0x00)
#define GPO1_HI       outportb(0xA02, GPO1)
#define GPO1_LO       outportb(0xA02, 0x00)
#define GPO2_HI       outportb(0xA07, GPO2)
#define GPO2_LO       outportb(0xA07, 0x00)
#define GPO3_HI       outportb(0xA07, GPO3)
#define GPO3_LO       outportb(0xA07, 0x00)

void main(void)
{
    GPO0_HI;
    GPO1_LO;
    GPO2_HI;
    GPO3_LO;
}
```

APPENDIX C: WATCHDOG TIMER SETTING

ITE8786 WatchDog Programming Guide

```
#define SUPERIO_PORT    0x2E
#define WDT_SET        0x72
#define WDT_VALUE      0x73

void main(void)
{
    #Enter SuperIO Configuration
    outputb(SUPERIO_PORT, 0x87);
    outputb(SUPERIO_PORT, 0x01);
    outputb(SUPERIO_PORT, 0x55);
    outputb(SUPERIO_PORT, 0x55);

    # Set LDN
    outputb(SUPERIO_PORT, 0x07);
    outputb(SUPERIO_PORT+1 ,0x07);

    # Set WDT setting
    outputb(SUPERIO_PORT, WDT_SET);
    outputb(SUPERIO_PORT+1, 0x90);           # Use the second
                                           # Use the minute, change value to 0x10

    # Set WDT sec/min
    outputb(SUPERIO_PORT, WDT_VALUE);
    outputb(SUPERIO_PORT+1, 0x05);         #Set 5 seconds
}
```

APPENDIX D: LED PROGRAMMING GUIDE

LEDs are provided for custom system design. This appendix provides definitions and its default setting for the LEDs in the NIFE 200 series. The LED definition is shown in the following table:

Pin	PowerOn Default	Address
GPO-PR0	High	A07h (Bit5)
GPO-PR1	High	A07h (Bit4)
GPO-PR2	High	A07h (Bit3)
GPO-PR3	High	A07h (Bit2)
GPO-PR4	High	A07h (Bit6)

Control the GPO (PR0/PR1/PR2/PR3/PR4) level from I/O port A07h bit (5/4/3/2/6). The bit is Set/Clear indicated output High/Low.