

Gladius G1220

12.1" Intel® Atom™ N2600 Rugged Tablet PC



Features

- 12.1" TFT active matrix with resistive touch
- Ultra low power consumption for 6-hour battery life
- Fully rugged for mobile POS or warehousing application
- Meeting MIL-STD-810F, IP54, 3ft. Drop Resistance
- High mobility with multiple connectivity (Bluetooth/WLAN)
- Hot-swappable redundant dual batteries

System	
CPU	Intel® Atom™ Processor N2600 dual-core 1.6GHz
Graphics Controller	Intel® GMA3600
Memory	2GB DDR3 SO-DIMM memory module installed
Chipset	Intel® NM10
BIOS	AMI Aptio® UEFI BIOS
Audio	1 x microphone
	2 x 2W speakers
	1 x Earphone jack
	1 x Microphone jack
Storage	1 x 32GB MLC SSD
	1 x 2.5" HDD/SSD Drive (optional)
Peripherals and Devices	
Camera	1 x 5.0 MP rear AF CMOS camera with w/o LED (optional)
WLAN & Bluetooth	1 x WLAN 802.11 a/b/g/n & Bluetooth 4.0 LE, class 2
I/O Interface	
USB Port	4 x USB 2.0 ports
Serial Port	1 x 20-pin connector for two RS-232 ports
Ethernet	1 x RJ45 GbE LAN
Docking Port	1 x 35-pin pogo connector for docking connection
SD Card	1 x SDHC/SD card slot
Button & Indicator	
Function Key	4 x Function keys
Power Button	1 x Power on/off button
LED Indicator	2 x Battery LEDs
	1 x HDD/SSD Active LED
	1 x Power LED
Touch Screen	
Type	Analog resistive touch
Light Transparency	80%
Controller Interface	USB Interface



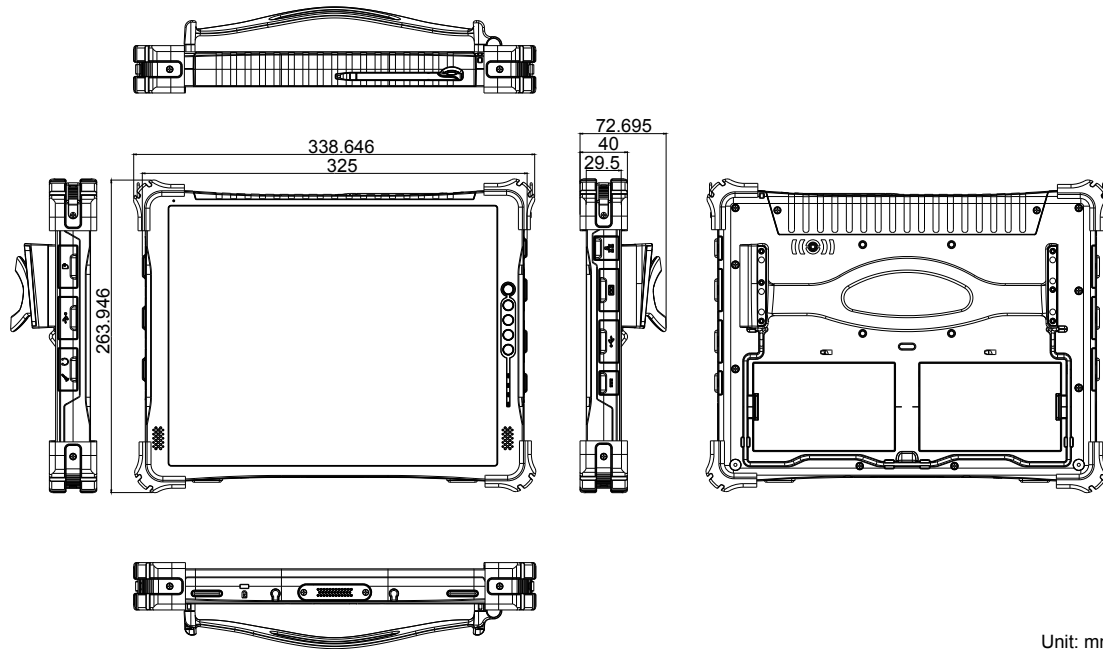

LCD Display	
Size/Type	12.1" TFT Active Matrix Panel
Max. Resolution	1024 x 768 (XGA) with 16.2M colors
Luminance	500 cd/m2 (typ.)
Contrast Ratio	700 :1
View Angle (U/D/R/L)	70°/70°/80°/80°
Backlight Type	LED
Power Supply	
Adapter Input	100 ~ 240VAC (full range)
Adapter Output	19VDC, 4.74A, 90W
Battery Type	Li-battery pack
Battery Capacity	2 x 1880mAh 4-cell external battery pack
Battery Life	Up to 6 hours (depends on configuration and use)
Mechanical & Environmental	
Operating Temp.	-20 ~ 40°C (-4 ~ 104°F)
Charging Temp.	0 ~ 40°C (32 ~ 104°F)
Storage Temp.	-20 ~ 60°C (-4 ~ 140°F)
Operating Humidity	10 ~ 95% @ 40°C (non-condensing)
Dimensions (W x H x D)	320 x 246 x 29.5 mm (12.60" x 9.69" x 1.16")
Gross Weight	1.9 Kg (4.19 lb)
Vibration	3 Grms/ 5 ~ 500Hz/ random operation
Shock	40G peak acceleration (11 ms duration)
Transit Drop	3 ft., except the front side
IP Rating	IP54 (whole unit)
Regulatory	CE/FCC Class B, VCCI, PSE and TELEC certified
OS Support	
Windows Embedded 7 / Windows 7 Professional	
Ordering Information	
G1220	12.1" Intel® Cedar Trail N2600 Rugged Tablet PC with dual external battery packs, Bluetooth and WiFi

Dimensions











Unit: mm

Standard Accessories

PAC-G090W	20V/4.5A 90W AC/DC adapter kit	
Battery Pack	2 x 1880mAh 4-cell external battery pack	
Stylus	Touch screen stylus (with rope)	
RS232 COM Cable	1-to-2 RS232 cable	

Optional Accessories

PAC-G090W	20V/4.5A 90W AC/DC adapter kit	
eBAT-1220	1 x 1880mAh 4-cell external battery pack	
Stylus	Touch screen stylus	
Stand-1220	Desktop stand	
HST-1220	For one-handed hold of the computer	
SST-1220	Shoulder Strap, 128 x 3.7cm	
RS232 COM Cable	1-to-2 RS232 cable	
DTC-1220	Desktop cradle for G1220	

Optional Configuration (CTOS* Kit) (Not Sold Separately)

HDD320G-1220	320GB HDD kit	
CAM-1220	5.0M rear CMOS camera kit	