

MD-200 Series Quick Installation Guide

Version 2.1, January 2021

Technical Support Contact Information
www.moxa.com/support

MOXA[®]

© 2021 Moxa Inc. All rights reserved.

P/N: 1802002260012



Overview

The MD-200 marine display series is designed for durably reliable service as an ECDIS display component. The MD-200 series offers full range dimming and optional optical bonding, making it well-suited not only for ECDIS applications, but also for a variety of other bridge applications.

The MD-200 series features both AC and DC power inputs, and can be conveniently installed on any bridge, without the need for extra hardware.

Moxa's marine displays are compliant with the most important industrial marine standards, including IEC 60945, DNV, and IACS-E10, giving strong assurance of their suitability for marine applications.

The following lists the models in the MD-200 series:

- MD-226X: 26-inch display with 16:10 aspect ratio.
- MD-224X/MD-224Z: 24-inch display with 16:9 aspect ratio.
- MD-219X/MD-219Z: 19-inch display with 5:4 aspect ratio.

Package Checklist

Before installing the MD-200 series, verify that the package contains the following items:

- MD-200 series display
- VGA cable
- DVI-D cable
- 2-pin terminal block x 1
- 5-pin terminal block x 2
- Quick installation guide (printed)
- Warranty card

NOTE: Please notify your sales representative if any of the above items are missing or damaged.

Hardware Installation

Appearance

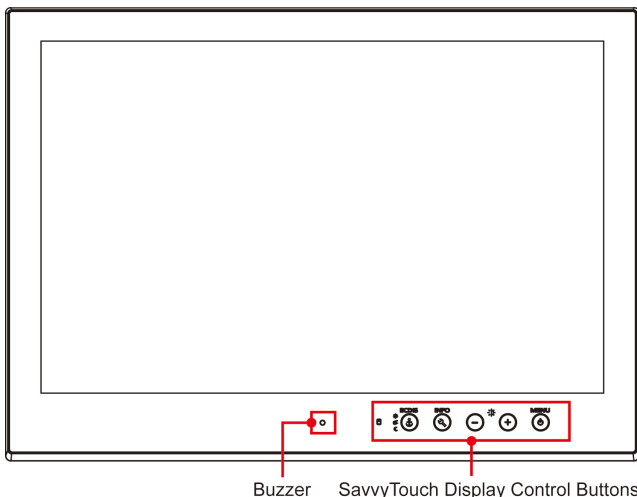

MD-226/224

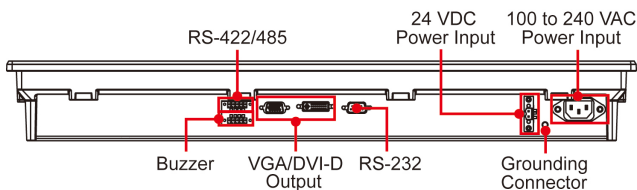



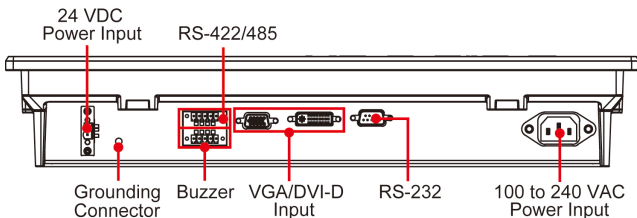

MD-219



SavvyTouch Display Control Buttons

The following table describes the SavvyTouch display controls on the front surface of the MD-200 series. These intelligent controls will light up with a simple wave of your hand over the area of the screen where they are located.

Name	Display Color	Control Function/Color Legend
 Menu/ Power	Green	Display is powered on and functioning normally. Touch the button to show the OSD settings menu
	Red	No input signal detected. Display standby
	Off	Power is down and the display is off
 Brightness	White	+: To increase brightness of panel
		-: To decrease brightness of panel
 Info	Off	AC/DC power is functioning normally
 Display mode	White	Switch between DAY/DUSK/NIGHT brightness modes
	Off	Panel brightness out of default range

Installing the MD-200 Series

Desktop

The MD-200 series comes with optional brackets that allow you to install the display on a horizontal surface, such as a desktop. Three round screws are required for each bracket. See the figure for detailed screw specifications and their torque values.

Place your MD-200 series display on a clean, flat, well-ventilated desktop. To protect the computer from overheating, leave some ventilation space between the MD-200 series and other equipment.

Do NOT place equipment or objects on the panel, as this might damage internal components.

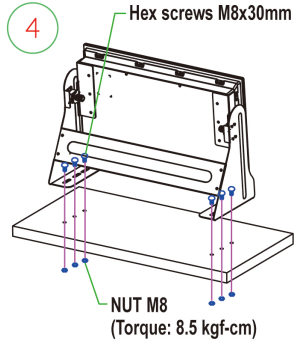
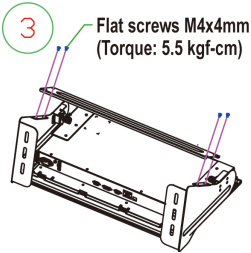
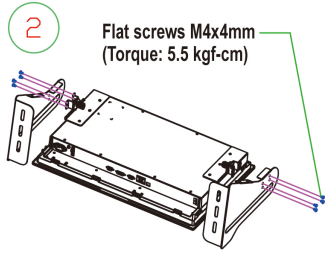
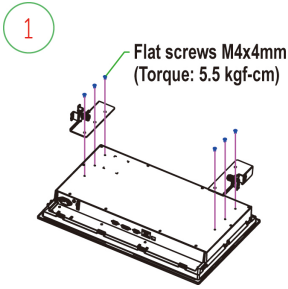

Panel Mounting

The MD-200 series comes with 14 optional clamp mounts for installation on a wall (where space has been cut out to accommodate the rest of the hardware) or into computing stations where a flush mount is desired.

The maximum thickness of the surface to which the computer can be clamped is 11 mm. For a secure mounting, all 14 clamps must be used.

The clamp arms are fastened into slots on all four sides of the MD-200 series. Use the short M4 SUS screws to fasten the clamp arms to the MD-200 series mounting slots, as shown in the following magnified inset in the diagram. Next, use the clamps to fasten the MD-200 series to its mounting point; please note the torque value as shown in the figure.

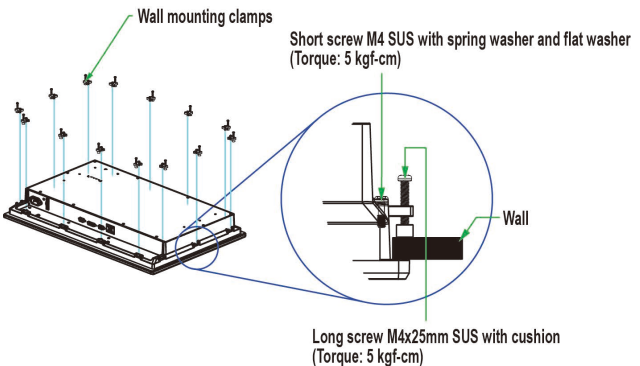

VESA Mounting

The MD-200 series also comes with an optional VESA mounting kit. Six flat screws and four round screws are required to fasten the VESA mounting bracket. See the following figure for detailed screw specifications and torque values.

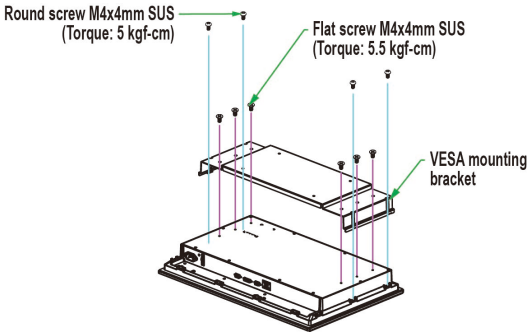

An additional four screws (not included in the kit) are required to mount the display on a VESA rack. For this purpose, use M6 screws that are between 10 and 12 mm in length.

Connector Description

Extending the Display

The MD-200 series comes with both standard VGA and DVI-D interfaces on the bottom panel. It automatically detects whether the input video source is from the VGA or DVI-D interface.

Configuring the Display via the Serial Port

The MD-200 series has two serial ports. The RS-232 port uses a DB9 connector, and the RS-422/485 port uses a terminal block connector. Either serial port can be used to modify the display parameters using UART commands. For information on serial port configuration, see the MD-200 Series Hardware Manual.

The pin assignments for the ports are shown in the following table:

Pin	RS-232
1	DCD
2	RxD
3	TxD
4	DTR
5	GND
6	DSR
7	RTS
8	CTS

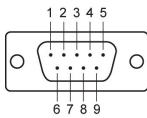

RS-422/485 (Terminal Block) Pinouts

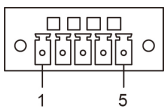

Pin	RS-422	RS-485 (4-wire)	RS-485 (2-wire)
1	RxDB(+)	RxDB(+)	-
2	RxDA(-)	RxDA(-)	-
3	TxDB(+)	TxDB(+)	DataB(+)
4	TxDA(-)	TxDA(-)	DataA(-)
5	GND	GND	GND

Powering on/off the MD-200 Series

To power on the MD-200 series, connect the unit to an AC power source, a DC power source, or both. Touch the MENU button for 1 second to turn on the display. Touch the MENU button for 4 seconds to turn off the display.

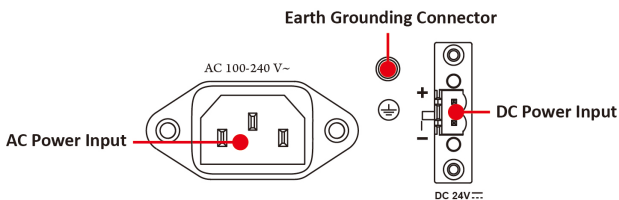

Grounding the MD-200 Series

Proper grounding and wire routing help to limit the effects of noise from electromagnetic interference (EMI). Run the ground connection from the ground screw to the grounding surface prior to connecting the power source.

For detailed configuration of the MD-200 Series, refer to the MD-200 Series Hardware Manual.