

**MODEL:
IMBA-Q370**

ATX Motherboard Supports 8th/9th Gen. 14nm LGA1151 Intel® Core™ i9/i7/i5/i3, Celeron® and Pentium® Processor, DDR4, Triple Independent Displays, Dual GbE LAN, M.2, USB 3.2 Gen 2 (10Gb/s), SATA 6Gb/s, HD Audio and RoHS

User Manual

Revision

Date	Version	Changes
January 14, 2020	1.02	Modified the part number of the optional serial port cable in Table 2-2.
July 8, 2019	1.01	Added a new supported processor - 9 th generation Intel® Core™ i9 Processor
May 9, 2018	1.00	Initial release

Copyright

COPYRIGHT NOTICE

The information in this document is subject to change without prior notice in order to improve reliability, design and function and does not represent a commitment on the part of the manufacturer.

In no event will the manufacturer be liable for direct, indirect, special, incidental, or consequential damages arising out of the use or inability to use the product or documentation, even if advised of the possibility of such damages.

This document contains proprietary information protected by copyright. All rights are reserved. No part of this manual may be reproduced by any mechanical, electronic, or other means in any form without prior written permission of the manufacturer.

TRADEMARKS

All registered trademarks and product names mentioned herein are used for identification purposes only and may be trademarks and/or registered trademarks of their respective owners.

Manual Conventions



WARNING

Warnings appear where overlooked details may cause damage to the equipment or result in personal injury. Warnings should be taken seriously.



CAUTION

Cautionary messages should be heeded to help reduce the chance of losing data or damaging the product.



NOTE

These messages inform the reader of essential but non-critical information. These messages should be read carefully as any directions or instructions contained therein can help avoid making mistakes.

Table of Contents

1 INTRODUCTION.....	1
1.1 INTRODUCTION.....	2
1.2 FEATURES.....	3
1.3 CONNECTORS	4
1.4 DIMENSIONS.....	5
1.5 DATA FLOW	6
1.6 TECHNICAL SPECIFICATIONS	7
2 PACKING LIST.....	10
2.1 ANTI-STATIC PRECAUTIONS.....	11
2.2 UNPACKING PRECAUTIONS.....	11
2.3 PACKING LIST.....	12
2.4 OPTIONAL ITEMS.....	13
3 CONNECTORS	15
3.1 PERIPHERAL INTERFACE CONNECTORS.....	16
3.1.1 <i>IMBA-Q370 Layout</i>	16
3.1.2 <i>Peripheral Interface Connectors</i>	17
3.1.3 <i>External Interface Panel Connectors</i>	18
3.2 INTERNAL PERIPHERAL CONNECTORS	19
3.2.1 <i>+12V ATX Power Connector</i>	19
3.2.2 <i>Additional Power Connector</i>	20
3.2.3 <i>ATX Power Connector</i>	20
3.2.4 <i>Battery Connector</i>	22
3.2.5 <i>Chassis Intrusion Connector</i>	23
3.2.6 <i>DDR4 DIMM Slots</i>	24
3.2.7 <i>Digital I/O Connector</i>	25
3.2.1 <i>DisplayPort Connector</i>	26
3.2.2 <i>EC Debug Connector</i>	27
3.2.3 <i>Fan Connector (CPU)</i>	28

3.2.4 Fan Connectors (System).....	29
3.2.5 Front Panel Audio Connector.....	30
3.2.6 Front Panel Connector	31
3.2.7 I ² C Connector	32
3.2.8 Keyboard and Mouse Connector	33
3.2.9 LAN LED Connectors	34
3.2.10 M.2 2230 Slot, A-Key.....	35
3.2.11 M.2 2280 Slot, M-Key	37
3.2.12 PCI Slots	39
3.2.13 PCIe x4 Slots.....	39
3.2.14 PCIe x8 Slots.....	40
3.2.15 Power Button	41
3.2.16 SATA 6Gb/s Drive Connector	42
3.2.17 Serial Port Connectors, RS-232.....	43
3.2.18 Serial Port Connectors, RS-232/422/485	44
3.2.19 SMBus Connector	45
3.2.20 SPI Flash Connector.....	46
3.2.21 SPI Flash Connector, EC.....	47
3.2.22 TPM Connector.....	48
3.2.23 USB 2.0 Connectors.....	49
3.2.24 USB 3.2 Gen 1 Connector.....	50
3.3 EXTERNAL PERIPHERAL INTERFACE CONNECTOR PANEL	51
3.3.1 Audio Connector	51
3.3.2 Ethernet and USB 3.2 Connectors	52
3.3.3 HDMI and DP++ Connector.....	53
3.3.4 Keyboard/Mouse and USB 2.0 Connectors	55
3.3.5 VGA and RS-232 Connectors.....	56
4 INSTALLATION	58
4.1 ANTI-STATIC PRECAUTIONS.....	59
4.2 INSTALLATION CONSIDERATIONS.....	59
4.3 SOCKET LGA1151 CPU INSTALLATION	61
4.4 SOCKET LGA1151 COOLING KIT INSTALLATION	64
4.5 DIMM INSTALLATION	66
4.6 SYSTEM CONFIGURATION.....	67

IMBA-Q370 ATX Motherboard

4.6.1 AT/ATX Power Mode Setting	67
4.6.2 Clearing CMOS	68
4.6.3 Flash Descriptor Security Override Jumper.....	68
4.6.4 USB Power Selection	70
4.7 INTERNAL PERIPHERAL DEVICE CONNECTIONS.....	70
4.7.1 SATA Drive Connection	70
4.8 SOFTWARE INSTALLATION	73
4.9 DRIVER DOWNLOAD	73
4.10 INTEL® AMT SETUP PROCEDURE.....	75
5 BIOS.....	76
5.1 INTRODUCTION.....	77
5.1.1 Starting Setup.....	77
5.1.2 Using Setup	77
5.1.3 Getting Help.....	78
5.1.4 Unable to Reboot after Configuration Changes	78
5.1.5 BIOS Menu Bar.....	79
5.2 MAIN.....	79
5.3 ADVANCED.....	81
5.3.1 CPU Configuration	82
5.3.2 PCH-FW Configuration.....	83
5.3.3 Trusted Computing.....	85
5.3.4 ACPI Settings.....	86
5.3.5 iWDD H/W Monitor.....	87
5.3.5.1 Smart Fan Mode Configuration	88
5.3.6 F81866 Super IO Configuration	89
5.3.6.1 Serial Port n Configuration	90
5.3.6.2 Serial Port 1 Configuration.....	90
5.3.6.3 Serial Port 2 Configuration.....	91
5.3.6.4 Serial Port 3 Configuration.....	92
5.3.6.5 Serial Port 4 Configuration.....	93
5.3.6.6 Serial Port 5 Configuration.....	94
5.3.6.7 Serial Port 6 Configuration.....	96
5.3.6.8 Parallel Port Configuration.....	98
5.3.7 RTC Wake Settings.....	99

5.3.8 Serial Port Console Redirection	100
5.3.8.1 Legacy Console Redirection Settings	103
5.3.9 USB Configuration.....	104
5.3.10 NVMe Configuration.....	105
5.3.11 iEi Feature.....	106
5.4 CHIPSET	107
5.4.1 System Agent (SA) Configuration	108
5.4.1.1 Memory Configuration	108
5.4.1.2 Graphics Configuration.....	109
5.4.1.3 PEG Port Configuration.....	111
5.4.2 PCH-IO Configuration	113
5.4.2.1 PCI Express Configuration	115
5.4.2.2 SATA Configuration.....	118
5.4.2.3 HD Audio Configuration.....	120
5.5 SECURITY.....	121
5.6 BOOT.....	122
5.7 SAVE & EXIT	124
A REGULATORY COMPLIANCE	125
B PRODUCT DISPOSAL	127
C BIOS OPTIONS	129
D DIGITAL I/O INTERFACE.....	133
D.1 INTRODUCTION.....	134
D.2 ASSEMBLY LANGUAGE SAMPLE 1.....	135
D.3 ASSEMBLY LANGUAGE SAMPLE 2.....	135
E WATCHDOG TIMER.....	136
F INTEL® MATRIX STORAGE MANAGER.....	139
F.1 INTRODUCTION.....	140
<i>F.1.1 Precautions</i>	140
F.2 FEATURES AND BENEFITS	141
F.3 ACCESSING THE INTEL® MATRIX STORAGE MANAGER.....	141
F.4 INSTALLING THE OPERATING SYSTEM TO THE RAID ARRAY	142
G ERROR BEEP CODE	143

IMBA-Q370 ATX Motherboard

G.1 PEI BEEP CODES	144
G.2 DXE BEEP CODES	144
H HAZARDOUS MATERIALS DISCLOSURE	145
H.1 RoHS II DIRECTIVE (2015/863/EU)	146
H.2 CHINA RoHS.....	147

List of Figures

Figure 1-1: IMBA-Q370	2
Figure 1-2: Connectors	4
Figure 1-3: IMBA-Q370 Dimensions (mm).....	5
Figure 1-4: Data Flow Diagram.....	6
Figure 3-1: Peripheral Interface Connectors	16
Figure 3-2: +12V ATX Power Connector Pinout Location	19
Figure 3-3: Additional Power Connector Location.....	20
Figure 3-4: ATX Power Connector Location	21
Figure 3-5: Battery Connector Location.....	22
Figure 3-6: Chassis Intrusion Connector Location.....	23
Figure 3-7: DDR4 DIMM Slot Locations	24
Figure 3-8: Digital I/O Connector Location	25
Figure 3-9: DisplayPort Connector Location	26
Figure 3-10: EC Debug Connector Location.....	27
Figure 3-11: CPU Fan Connector Location	28
Figure 3-12: System Fan Connector Locations.....	29
Figure 3-13: Front Panel Audio Connector Location	30
Figure 3-14: Front Panel Connector Location	31
Figure 3-15: I ² C Connector Location	32
Figure 3-16: Keyboard and Mouse Connector Location.....	33
Figure 3-17: LAN LED Connector Locations	34
Figure 3-18: M.2 2230 Slot Location	35
Figure 3-19: M.2 2280 Slot Location	37
Figure 3-20: PCI Slot Locations	39
Figure 3-21: PCIe x4 Slot Locations	40
Figure 3-22: PCIe x8 Slot Locations	40
Figure 3-23: Power Button Location.....	41
Figure 3-24: SATA 6Gb/s Drive Connector Locations	42
Figure 3-25: RS-232 Serial Port Connector Location.....	43
Figure 3-26: RS-232/422/485 Connector Location.....	44

IMBA-Q370 ATX Motherboard

Figure 3-27: SMBus Connector Location	45
Figure 3-28: SPI Flash Connector Location	46
Figure 3-29: SPI EC Flash Connector Location	47
Figure 3-30: TPM Connector Location.....	48
Figure 3-31: USB 2.0 Connector Pinout Locations	49
Figure 3-32: USB 3.2 Gen 1 Connector Location	50
Figure 3-33: External Peripheral Interface Connector	51
Figure 3-34: Audio Connector	52
Figure 3-35: HDMI Connector	54
Figure 3-36: HDMI Connector	54
Figure 3-37: COM1 Serial Port Pinout Locations	56
Figure 3-38: VGA Connector	57
Figure 4-1: Disengage the CPU Socket Load Lever.....	61
Figure 4-2: Remove Protective Cover.....	62
Figure 4-3: Insert the Socket LGA1151 CPU.....	63
Figure 4-4: Close the Socket LGA1151	63
Figure 4-5: Cooling Kit Support Bracket.....	65
Figure 4-6: DIMM Installation.....	66
Figure 4-7: AT/ATX Power Mode Switch Location	67
Figure 4-8: Clear CMOS Button and Header Locations	68
Figure 4-9: Flash Descriptor Security Override Jumper Location	69
Figure 4-10: SATA Drive Cable Connection.....	71
Figure 4-11: SATA Power Drive Connection.....	72
Figure 4-12: IEI Resource Download Center.....	73

List of Tables

Table 1-1: IMBA-Q370 Specifications	9
Table 2-1: Packing List.....	12
Table 2-2: Optional Items	14
Table 3-1: Peripheral Interface Connectors	18
Table 3-2: Rear Panel Connectors	19
Table 3-3: +12V ATX Power Connector Pinouts	19
Table 3-4: Additional Power Connector Pinouts	20
Table 3-5: ATX Power Connector Pinouts	21
Table 3-6: Chassis Intrusion Connector Pinouts	23
Table 3-7: Digital I/O Connector Pinouts.....	25
Table 3-8: EC Debug Connector Pinouts	27
Table 3-9: CPU Fan Connector Pinouts.....	28
Table 3-10: System Fan (SYS_FAN1) Connector Pinouts	29
Table 3-11: System Fan (SYS_FAN2) Connector Pinouts	29
Table 3-12: Front Panel Audio Connector Pinouts	30
Table 3-13: Front Panel Connector Pinouts.....	31
Table 3-14: I ² C Connector Pinouts.....	32
Table 3-15: Keyboard and Mouse Connector Pinouts	33
Table 3-16: LAN1 LED Connector (LED_LAN1) Pinouts.....	34
Table 3-17: LAN2 LED Connector (LED_LAN2) Pinouts.....	34
Table 3-18: M.2 2230 Connector Pinouts	36
Table 3-19: M.2 2280 Connector Pinouts	38
Table 3-20: SATA 6Gb/s Drive Connector Pinouts.....	42
Table 3-21: RS-232 Serial Port Connector Pinouts	43
Table 3-22: RS-232/422/485 Connector Pinouts	44
Table 3-23: DB-9 RS-232/422/485 Pinouts	45
Table 3-24: SMBus Connector Pinouts	46
Table 3-25: SPI Flash Connector Pinouts	46
Table 3-26: SPI EC Flash Connector Pinouts	47
Table 3-27: TPM Connector Pinouts	48

IMBA-Q370 ATX Motherboard

Table 3-28: USB 2.0 Connector Pinouts	49
Table 3-29: USB 3.2 Gen 1 Connector Pinouts	50
Table 3-30: USB 3.2 Port Pinouts	52
Table 3-31: LAN Pinouts	53
Table 3-32: HDMI Connector Pinouts	53
Table 3-33: DP++ Connector Pinouts	54
Table 3-34: USB 2.0 Port Pinouts	55
Table 3-35: PS/2 Connector Pinouts	55
Table 3-36: COM1 Connector Pinouts	56
Table 3-37: VGA Connector Pinouts	57
Table 4-1: AT/ATX Power Mode Switch Settings	67
Table 4-2: Flash Descriptor Security Override Jumper Settings	68
Table 4-3: BIOS Options and Configured USB Ports	70
Table 4-4: USB Power Source Setup	70
Table 5-1: BIOS Navigation Keys	78
Table 5-2: BIOS Options and Configured USB Ports	114

BIOS Menus

BIOS Menu 1: Main	80
BIOS Menu 2: Advanced	81
BIOS Menu 3: CPU Configuration	82
BIOS Menu 4: PCH-FW Configuration	84
BIOS Menu 5: Trusted Computing	85
BIOS Menu 6: ACPI Configuration	86
BIOS Menu 7: iWDD H/W Monitor	87
BIOS Menu 8: Smart Fan Mode Configuration	88
BIOS Menu 9: F81866 Super IO Configuration	89
BIOS Menu 10: Serial Port n Configuration Menu	90
BIOS Menu 11: Parallel Port Configuration Menu	98
BIOS Menu 12: RTC Wake Settings	99
BIOS Menu 13: Serial Port Console Redirection	100
BIOS Menu 14: Legacy Console Redirection Settings	103
BIOS Menu 15: USB Configuration	104
BIOS Menu 16: NVMe Configuration.....	105
BIOS Menu 17: iEi Feature	106
BIOS Menu 18: Chipset	107
BIOS Menu 19: System Agent (SA) Configuration	108
BIOS Menu 20: Memory Configuration.....	108
BIOS Menu 21: Graphics Configuration	109
BIOS Menu 22: PEG Port Configuration.....	111
BIOS Menu 23: PEG Port Feature Configuration.....	112
BIOS Menu 24: PCH-IO Configuration	113
BIOS Menu 25: PCI Express Configuration	115
BIOS Menu 26: PCIe Slot Configuration Submenu	116
BIOS Menu 27: SATA Configuration	118
BIOS Menu 28: HD Audio Configuration	120
BIOS Menu 29: Security	121
BIOS Menu 30: Boot	122

IMBA-Q370 ATX Motherboard

BIOS Menu 31: Save & Exit.....	124
--------------------------------	-----

Chapter

1

Introduction

1.1 Introduction

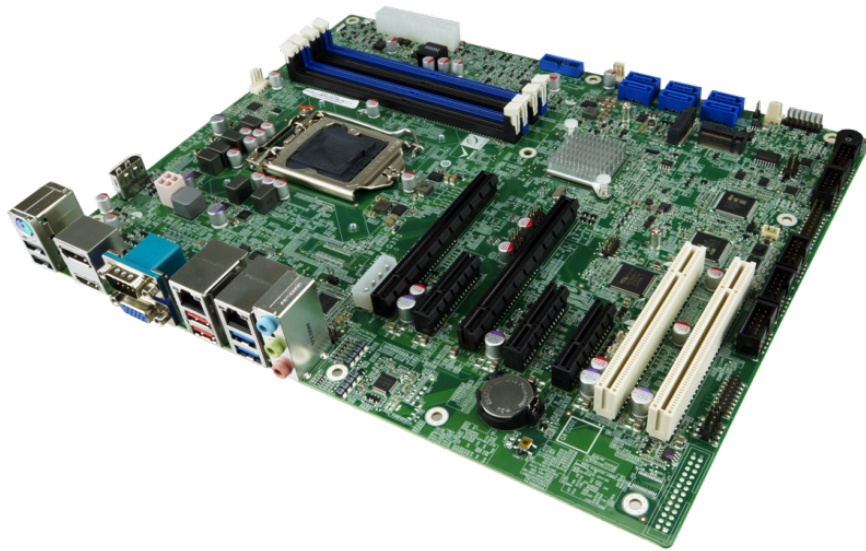

Figure 1-1: IMBA-Q370

The IMBA-Q370 is an ATX motherboard. It accepts a Socket LGA1151 Intel® Core™ i9/i7/i5/i3, Pentium® or Celeron® processor and supports four 288-pin 2666MHz dual-channel DDR4 DIMM modules up to 64 GB. The integrated Intel® Q370 chipset supports six SATA 6Gb/s drives. Moreover, the IMBA-Q370 includes DP++, HDMI and VGA interfaces for triple independent display.

The IMBA-Q370 provides two GbE interfaces through the Intel® I219LM (with Intel® AMT 11.0 support) and the Intel® I211AT PCIe controllers. Expansion and I/O include two PCI slots, two PCIe x8 slots, three PCIe x4 slots, two M.2 slots, two USB 3.2 Gen 1, two USB 3.2 Gen 2 and two USB 2.0 on the rear panel, four USB 2.0 via internal pin headers, two USB 3.2 Gen 1 via internal box header and six COM ports.

IMBA-Q370 ATX Motherboard

1.2 Features

Some of the IMBA-Q370 motherboard features are listed below:

- ATX form factor
- 8th/9th generation LGA1151 Intel® Core™ i9/i7/i5/i3, Pentium® or Celeron® processor supported
- Intel® Q370 chipset
- Four 288-pin 2666/2400 MHz dual-channel DDR4 DIMMs support up to 64 GB
- Two Intel® PCIe GbE connectors (LAN1 with Intel® AMT 11.0 support)
- Supports PCI Express Generation 3.0
- Triple independent display by DP++, HDMI and VGA interfaces
- Six SATA 6Gb/s connectors support RAID 0, 1, 5, 10
- Two USB 3.2 Gen 2 ports and two USB 3.2 Gen 1 ports on the rear panel
- One M.2 A-key slot for WLAN expansion; one M.2 M-key slot for storage
- Two PCIe x8 slots
- Three PCIe x4 slots
- Two PCI slots
- Six serial ports
- The optional expansion cards provide more choices to meet user's demand
- TPM 2.0 hardware security function supported by TPM module
- High Definition Audio
- RoHS compliant

1.3 Connectors

The connectors on the IMBA-Q370 are shown in the figure below.

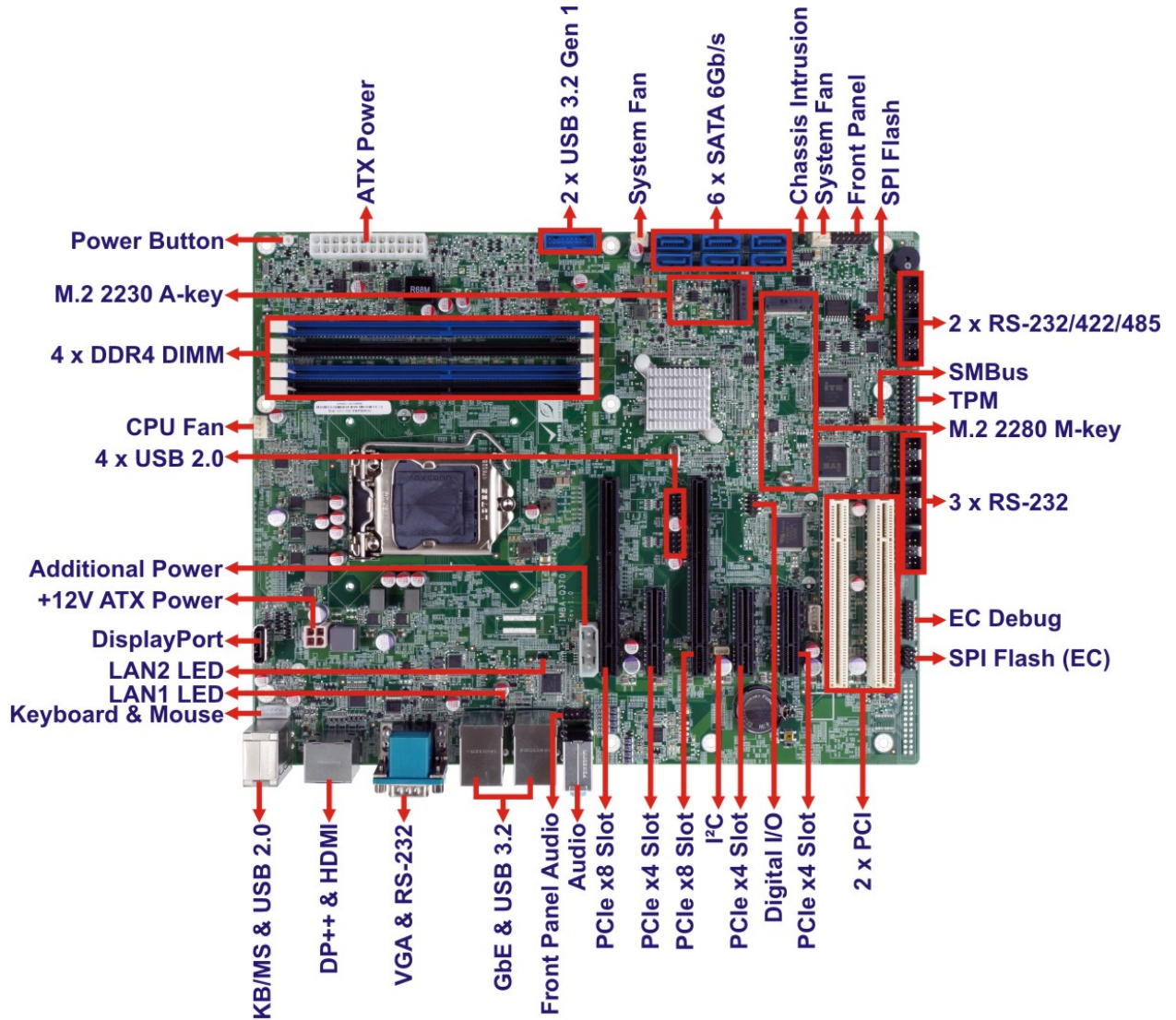

Figure 1-2: Connectors

IMBA-Q370 ATX Motherboard

1.4 Dimensions

The main dimensions of the IMBA-Q370 are shown in the diagram below.

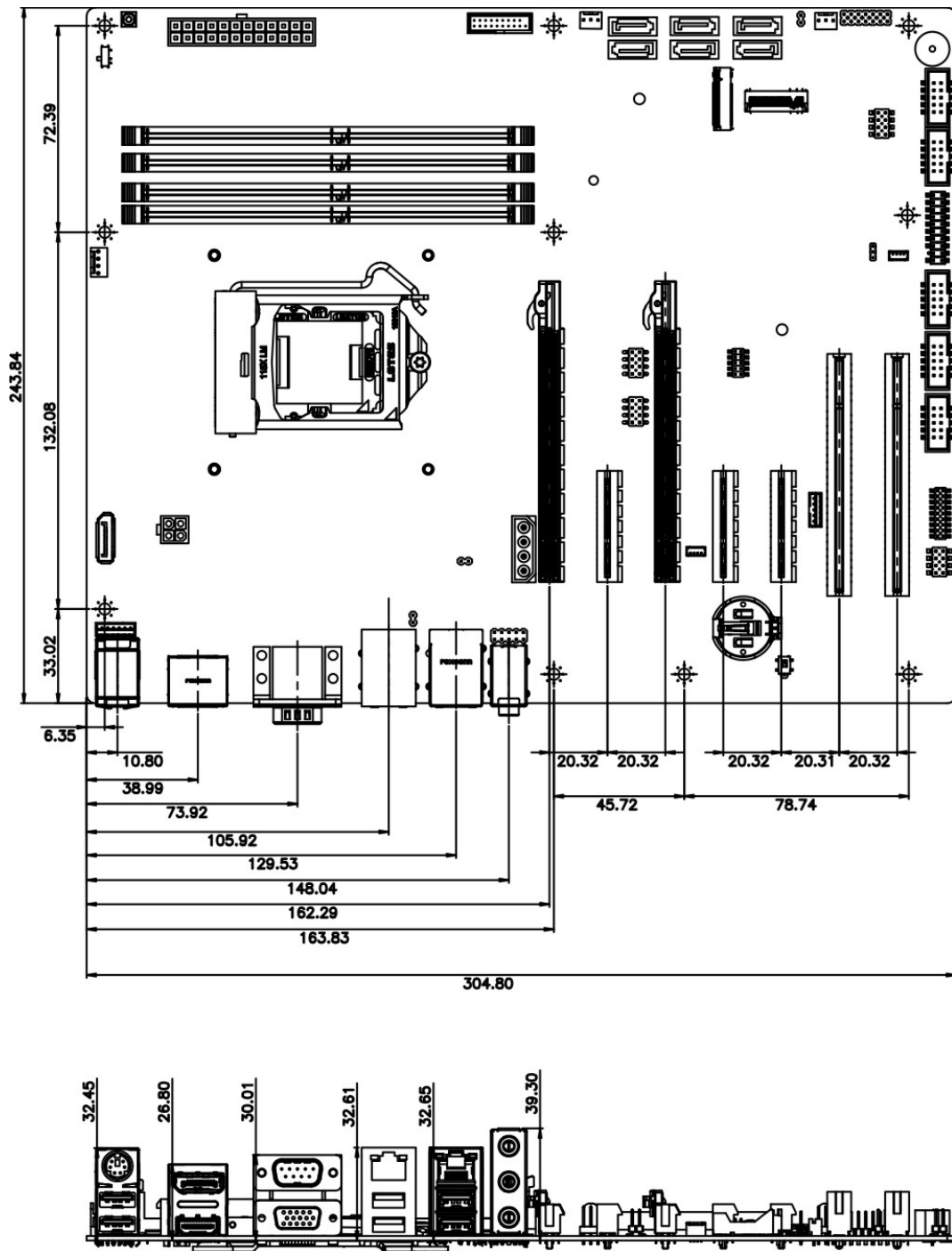

Figure 1-3: IMBA-Q370 Dimensions (mm)

1.5 Data Flow

Figure 1-4 shows the data flow between the system chipset, the CPU and other components installed on the motherboard.

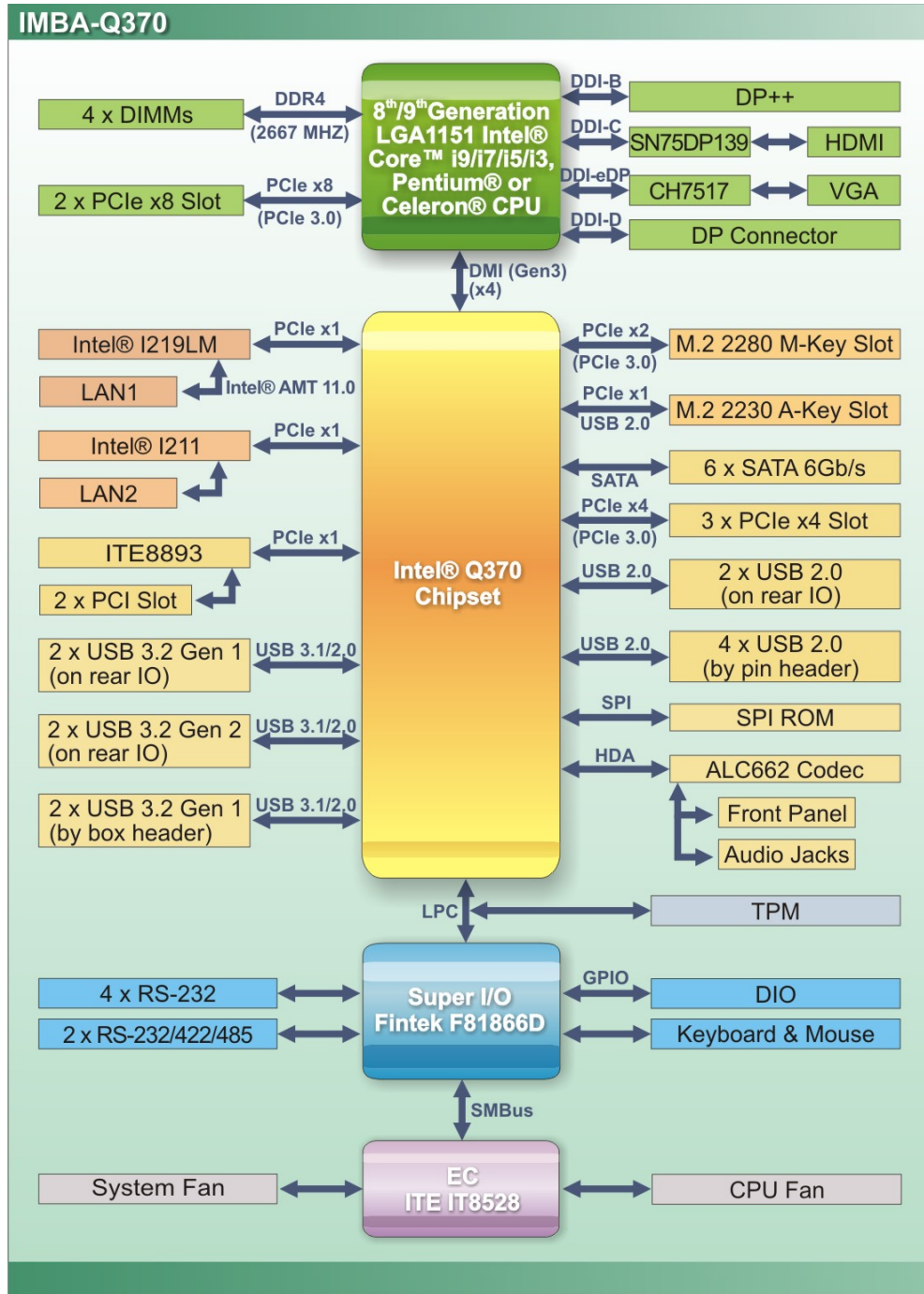

Figure 1-4: Data Flow Diagram

IMBA-Q370 ATX Motherboard

1.6 Technical Specifications

The IMBA-Q370 technical specifications are listed below.

Specification/Model	IMBA-Q370
Form Factor	ATX
CPU Supported	8 th /9 th generation LGA1151 Intel® Core™ i9/i7/i5/i3, Pentium® or Celeron® CPU
Chipset	Intel® Q370
Memory	Four 288-pin 2666/2400 MHz dual-channel unbuffered DDR4 SDRAM DIMMs supported (system max. 64 GB)
Graphics Engine	Intel® HD Graphics Gen9 engine with 16 low-power execution units, supporting DirectX 11.3/12, OpenGL 4.3/4.4/4.5 and OpenCL 1.2/2.0/2.1
Display Output	Triple independent display One VGA (up to 1920x1080@60Hz) One DP++ (up to 4096x2304@60Hz) One HDMI (up to 4096x2304@30Hz) One DisplayPort (internal, up to 4096x2304@60Hz)
Ethernet Controllers	LAN1: Intel® I219LM PCIe GbE controller with Intel® AMT 11.0 support (LAN1_USB1) LAN2: Intel® I211AT PCIe GbE controller (LAN2_USB2)
Audio	Realtek ALC662 HD Audio codec supports 5.1 channels
BIOS	UEFI BIOS
Super I/O Controller	Fintek F81866D
Watchdog Timer	Software programmable supports 1~255 sec. system reset
Expansions	2 x PCIe x8 (PCIe x16 connector interface) 3 x PCIe x4 2 x PCI 1 x M.2 2230 slot (A key, PCIe x1 + USB 2.0 signal) 1 x M.2 2280 slot (M key, PCIe x2 only, support NVMe SSD)

I/O Interface Connectors	
Audio Connectors	Line-in, line-out and mic-in audio jacks on rear panel One internal front panel audio connector (10-pin header)
Chassis Intrusion	One 2-pin header
Digital I/O	8-bit digital I/O
Ethernet	Two RJ-45 GbE ports
Fan	One 4-pin CPU smart fan connector One 3-pin system smart fan connector (SYS_FAN1) One 3-pin system fan connector
Front Panel	One 14-pin header (power LED, HDD LED, speaker, power button, reset button)
I²C	One 4-pin wafer connector
Keyboard and Mouse	One PS/2 keyboard/mouse connector One internal keyboard and mouse connector (6-pin wafer)
LAN LED	Two 2-pin headers for LAN1 LED and LAN2 LED
Serial ATA	Six SATA 6Gb/s connectors (support RAID 0, 1, 5, 10)
Serial Ports	One RS-232 via DB-9 Three RS-232 via internal box header Two RS-232/422/485 via internal box header
SMBus	One 4-pin wafer connector
TPM	One via 20-pin header
USB Ports	Two USB 3.2 Gen 2 ports on rear panel Two USB 3.2 Gen 1 ports on rear panel Two USB 2.0 ports on rear panel Four USB 2.0 ports via internal pin header Two USB 3.2 Gen 1 ports via internal box header
Environmental and Power Specifications	
Power Supply	AT/ATX power supply

IMBA-Q370 ATX Motherboard

Power Consumption	3.3V@1.65A, 5V@3.4A, 12V@8.58A, 5VSB@3.4A (4.0 GHz Intel® Core™ i7-8700K CPU with 32 GB 2600 MHz DDR4 memory)
Operating Temperature	-20°C ~ 60°C
Storage Temperature	-30°C ~ 70°C
Operating Humidity	5% ~ 95% (non-condensing)
Physical Specifications	
Dimensions	244 mm x 305 mm
Weight (GW/NW)	1200 g/700 g

Table 1-1: IMBA-Q370 Specifications

Chapter

2

Packing List

IMBA-Q370 ATX Motherboard

2.1 Anti-static Precautions



WARNING!

Static electricity can destroy certain electronics. Make sure to follow the ESD precautions to prevent damage to the product, and injury to the user.

Make sure to adhere to the following guidelines:

- **Wear an anti-static wristband:** Wearing an anti-static wristband can prevent electrostatic discharge.
- **Self-grounding:** Touch a grounded conductor every few minutes to discharge any excess static buildup.
- **Use an anti-static pad:** When configuring any circuit board, place it on an anti-static mat.
- **Only handle the edges of the PCB:** Don't touch the surface of the motherboard. Hold the motherboard by the edges when handling.

2.2 Unpacking Precautions

When the IMBA-Q370 is unpacked, please do the following:

- Follow the anti-static guidelines above.
- Make sure the packing box is facing upwards when opening.
- Make sure all the packing list items are present.

2.3 Packing List



NOTE:

If any of the components listed in the checklist below are missing, do not proceed with the installation. Contact the IEI reseller or vendor the IMBA-Q370 was purchased from or contact an IEI sales representative directly by sending an email to sales@ieiworld.com.

The IMBA-Q370 is shipped with the following components:





Quantity	Item and Part Number	Image
1	IMBA-Q370 single board computer	
2	SATA cable	
1	I/O shielding	
1	Quick installation guide	

Table 2-1: Packing List

IMBA-Q370 ATX Motherboard

2.4 Optional Items

The following are optional components which may be separately purchased:

Item and Part Number	Image
PS/2 KB/MS Y-cable with bracket (P/N: 19800-000075-RS)	
Dual-port USB cable with bracket (P/N: 19800-003100-100-RS)	
USB 3.2 cable with bracket, 457 mm (P/N: 19800-010500-200-RS)	
SATA power cable (P/N: 32102-000100-200-RS)	
Serial port cable, P=2.54, 230 mm (P/N: 32205-000702-200-RS)	
High-performance LGA1155/LGA1156 cooler kit (1U chassis compatible, 45W) (P/N: CF-115XC-R10)	
High-performance LGA1155/LGA1156 cooler kit (1U chassis compatible, 65W) (P/N: CF-115XD-R10)	
High-performance LGA1155/LGA1156 cooler kit (95W) (P/N: CF-115XE-R10)	

Item and Part Number	Image
20-pin Infineon TPM 2.0 module, software management tool, firmware v5.5 (P/N: TPM-IN02-R20)	

Table 2-2: Optional Items

Chapter

3

Connectors

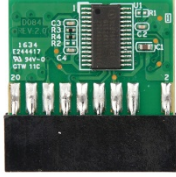
3.1 Peripheral Interface Connectors

This chapter details all the peripheral interface connectors.

3.1.1 IMBA-Q370 Layout

The figures below show all the peripheral interface connectors.

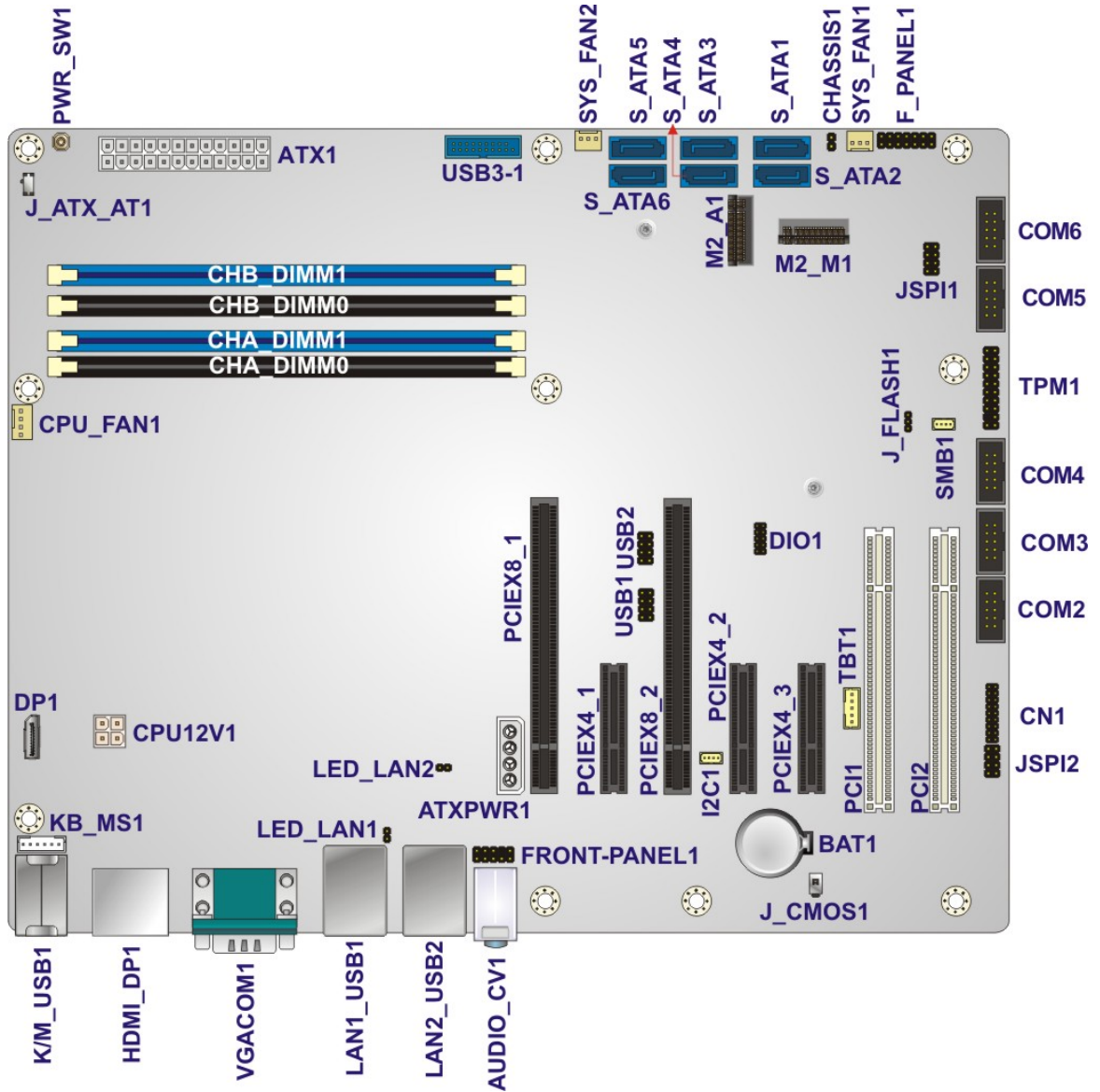

Figure 3-1: Peripheral Interface Connectors

IMBA-Q370 ATX Motherboard

3.1.2 Peripheral Interface Connectors

The table below lists all the connectors on the board.

Connector	Type	Label
+12V ATX power connector	4-pin Molex power connector	CPU12V1
Additional power connector	4-pin connector	ATXPWR1
ATX power connector	24-pin connector	ATX1
Battery connector	Battery holder	BAT1
Chassis intrusion connector	2-pin header	CHASSIS1
DDR4 DIMM sockets	288-pin socket	CHA_DIMM0, CHA_DIMM1, CHB_DIMM0, CHB_DIMM1
Digital I/O connector	10-pin header	DIO1
DisplayPort connector	180° DisplayPort	DP1
EC debug connector	18-pin header	CN1
Fan connector (CPU)	4-pin wafer	CPU_FAN1
Fan connectors (system)	3-pin wafer	SYS_FAN1, SYS_FAN2
Front panel audio connector	10-pin header	FRONT-PANEL1
Front panel connector	14-pin header	F_PANEL1
I ² C connector	4-pin wafer	I2C1
Keyboard and mouse connector	6-pin wafer	KB_MS1
LAN1 LED connector	2-pin header	LED_LAN1
LAN2 LED connector	2-pin header	LED_LAN2
M.2 2230 slot	A-key slot	M2_A1
M.2 2280 slot	M-key slot	M2_M1
PCI slots	PCI slot	PCI1, PCI2

Connector	Type	Label
PCIe x4 slots	PCIe x4 slot	PCIEX4_1, PCIEX4_2, PCIEX4_3
PCIe x8 slots	PCIe x8 slot	PCIEX8_1, PCIEX8_2
Power button	Push button	PWR_SW1
SATA 6Gb/s drive connectors	7-pin SATA connector	S_ATA1, S_ATA2, S_ATA3, S_ATA4, S_ATA5, S_ATA6
Serial ports, RS-232	10-pin box header	COM2, COM3, COM4
Serial ports, RS-232/422/485	10-pin box header	COM5, COM6
SMBus connector	4-pin wafer	SMB1
SPI flash connector	8-pin header	JSPI1
SPI flash connector, EC	8-pin header	JSPI2
TPM connector	20-pin header	TPM1
USB 2.0 connectors	8-pin header	USB1, USB2
USB 3.2 Gen 1 connector	19-pin box header	USB3-1

Table 3-1: Peripheral Interface Connectors

3.1.3 External Interface Panel Connectors

The table below lists the connectors on the external I/O panel.

Connector	Type	Label
Audio connectors	Audio jacks	AUDIO_CV1
DP++ and HDMI connector	DisplayPort, HDMI	HDMI_DP1
Ethernet and USB 3.2 Gen 2 ports	RJ-45, USB 3.2 Gen 2 Type A	LAN1_USB1

IMBA-Q370 ATX Motherboard

Connector	Type	Label
Ethernet and USB 3.2 Gen 1 ports	RJ-45, USB 3.2 Gen 1 Type A	LAN2_USB2
Keyboard/mouse and USB 2.0 ports	PS/2, USB 2.0	K/M_USB1
VGA and RS-232 connectors	15-pin female, 9-pin male	VGACOM1

Table 3-2: Rear Panel Connectors

3.2 Internal Peripheral Connectors

The section describes all of the connectors on the IMBA-Q370.

3.2.1 +12V ATX Power Connector

CN Label: CPU12V1

CN Type: 4-pin Molex power connector, p=4.2 mm

CN Location: See **Figure 3-2**

CN Pinouts: See **Table 3-3**

This connector provides power to the CPU.

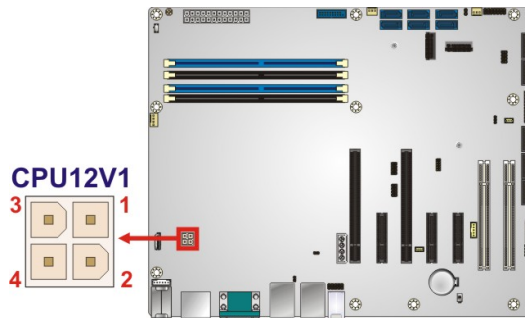

Figure 3-2: +12V ATX Power Connector Pinout Location

Pin	Description	Pin	Description
1	GND	2	GND
3	+12V	4	+12V

Table 3-3: +12V ATX Power Connector Pinouts

3.2.2 Additional Power Connector

- CN Label:** ATXPWR1
- CN Type:** 4-pin connector, p=5.08 mm
- CN Location:** See **Figure 3-3**
- CN Pinouts:** See **Table 3-4**

The additional power connector provides extra +12V and +5V power to the system.

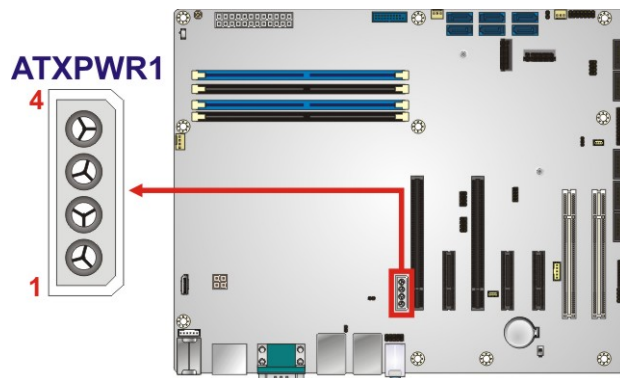

Figure 3-3: Additional Power Connector Location

Pin	Description
1	+12V
2	GND
3	GND
4	VCC

Table 3-4: Additional Power Connector Pinouts

3.2.3 ATX Power Connector

- CN Label:** ATX1
- CN Type:** 24-pin connector, p=4.2 mm
- CN Location:** See **Figure 3-4**
- CN Pinouts:** See **Table 3-5**

The ATX power connector connects to an ATX power supply.

IMBA-Q370 ATX Motherboard

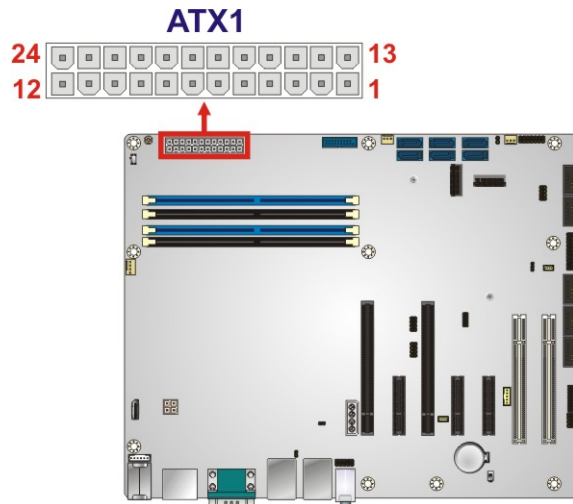

Figure 3-4: ATX Power Connector Location

Pin	Description	Pin	Description
1	+3.3V	13	+3.3V
2	+3.3V	14	-12V
3	GND	15	GND
4	+5V	16	PS_ON
5	GND	17	GND
6	+5V	18	GND
7	GND	19	GND
8	Power good	20	-5V
9	5VSB	21	+5V
10	+12V	22	+5V
11	+12V	23	+5V
12	+3.3V	24	GND

Table 3-5: ATX Power Connector Pinouts

3.2.4 Battery Connector

**CAUTION:**

Risk of explosion if battery is replaced by an incorrect type. Only certified engineers should replace the on-board battery.

Dispose of used batteries according to instructions and local regulations.

**NOTE:**

It is recommended to attach the RTC battery onto the system chassis in which the IMBA-Q370 is installed.

CN Label:	BAT1
CN Type:	Battery holder
CN Location:	See Figure 3-5

A system battery is placed in the battery holder. The battery provides power to the system clock to retain the time when power is turned off.

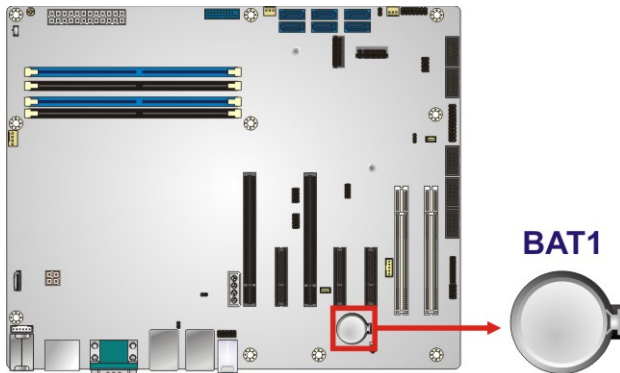

Figure 3-5: Battery Connector Location

IMBA-Q370 ATX Motherboard

3.2.5 Chassis Intrusion Connector

- CN Label:** CHASSIS1
- CN Type:** 2-pin header, p=2.54 mm
- CN Location:** See **Figure 3-6**
- CN Pinouts:** See **Table 3-6**

The chassis intrusion connector is for a chassis intrusion detection sensor or switch that detects if a chassis component is removed or replaced.

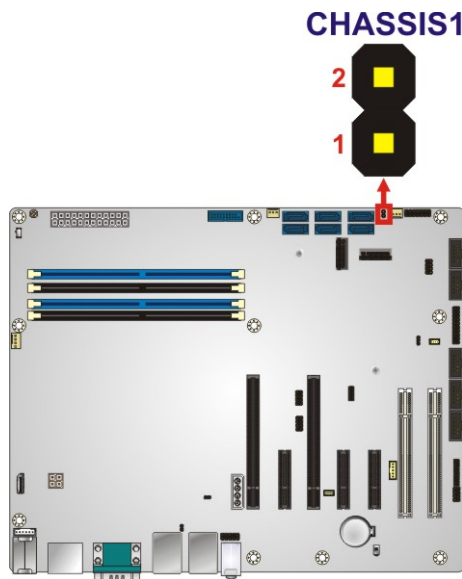

Figure 3-6: Chassis Intrusion Connector Location

Pin	Description
1	+3.3VSB
2	CHASSIS OPEN

Table 3-6: Chassis Intrusion Connector Pinouts

3.2.6 DDR4 DIMM Slots

CN Label: CHA_DIMM0, CHA_DIMM1, CHB_DIMM0, CHB_DIMM1

CN Type: DDR4 DIMM slot

CN Location: See **Figure 3-7**

The DIMM slots are for DDR4 DIMM memory modules.

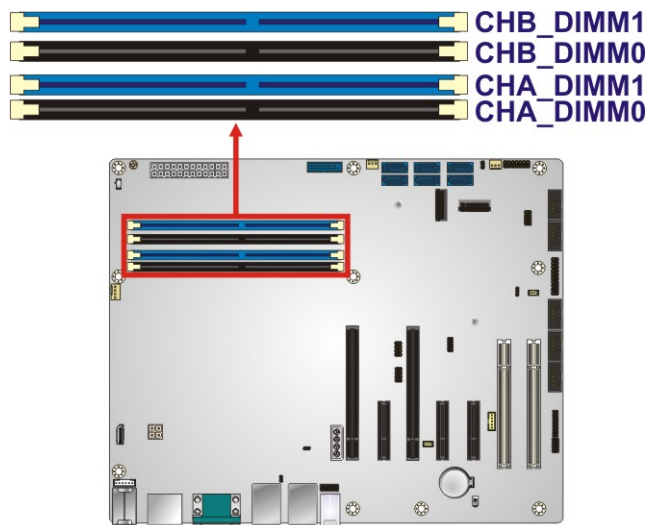

Figure 3-7: DDR4 DIMM Slot Locations

IMBA-Q370 ATX Motherboard

3.2.7 Digital I/O Connector

- CN Label:** DIO1
- CN Type:** 10-pin header, p=2 mm
- CN Location:** See **Figure 3-8**
- CN Pinouts:** See **Table 3-7**

The digital I/O connector provides programmable input and output for external devices.

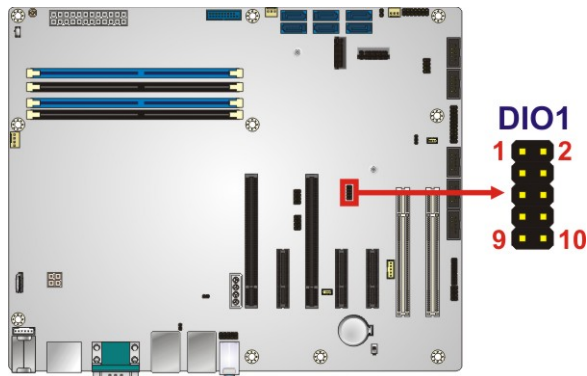

Figure 3-8: Digital I/O Connector Location

Pin	Description	Pin	Description
1	GND	2	VCC
3	Output 3	4	Output 2
5	Output 1	6	Output 0
7	Input 3	8	Input 2
9	Input 1	10	Input 0

Table 3-7: Digital I/O Connector Pinouts

3.2.1 DisplayPort Connector

- CN Label:** DP1
- CN Type:** 180° DisplayPort
- CN Location:** See **Figure 3-9**

The internal DisplayPort connector supports DisplayPort graphics interfaces.

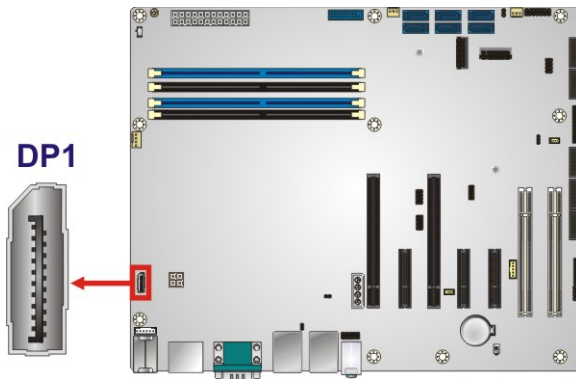

Figure 3-9: DisplayPort Connector Location

IMBA-Q370 ATX Motherboard

3.2.2 EC Debug Connector

- CN Label:** CN1
- CN Type:** 18-pin header, p=2 mm
- CN Location:** See **Figure 3-10**
- CN Pinouts:** See **Table 3-8**

The EC debug connector is used for EC debug.

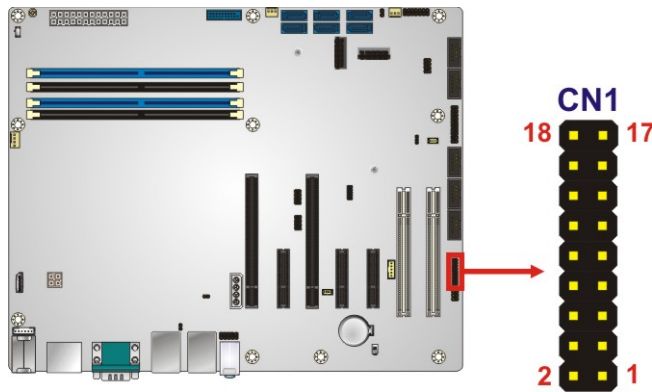

Figure 3-10: EC Debug Connector Location

Pin	Description	Pin	Description
1	EC_EPP_STB#	2	EC_EPP_AFD#
3	EC_EPP_PD0	4	NC
5	EC_EPP_PD1	6	EC_EPP_INIT#
7	EC_EPP_PD2	8	EC_EPP_SLIN#
9	EC_EPP_PD3	10	GND
11	EC_EPP_PD4	12	NC
13	EC_EPP_PD5	14	EC_EPP_BUSY
15	EC_EPP_PD6	16	EC_EPP_KSI5
17	EC_EPP_PD7	18	EC_EPP_KSI4

Table 3-8: EC Debug Connector Pinouts

3.2.3 Fan Connector (CPU)

- CN Label:** CPU_FAN1
- CN Type:** 4-pin wafer, p=2.54 mm
- CN Location:** See **Figure 3-11**
- CN Pinouts:** See **Table 3-9**

The fan connector attaches to a CPU cooling fan.

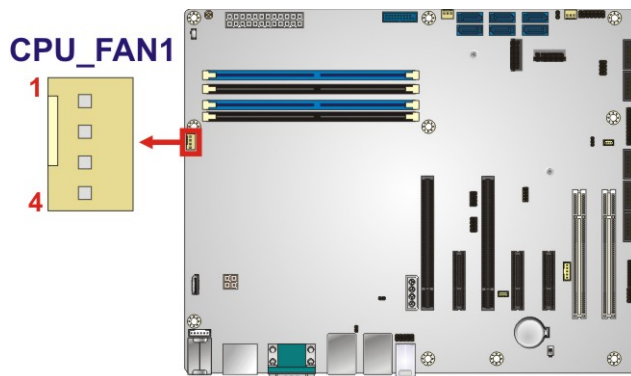

Figure 3-11: CPU Fan Connector Location

Pin	Description
1	GND
2	+12V
3	FANIO
4	PWM

Table 3-9: CPU Fan Connector Pinouts

IMBA-Q370 ATX Motherboard

3.2.4 Fan Connectors (System)

- CN Label:** SYS_FAN1, SYS_FAN2
- CN Type:** 3-pin wafer, p=2.54 mm
- CN Location:** See **Figure 3-12**
- CN Pinouts:** See **Table 3-10** and **Table 3-11**

Each fan connector attaches to a system cooling fan. The SYS_FAN1 provides smart fan function.

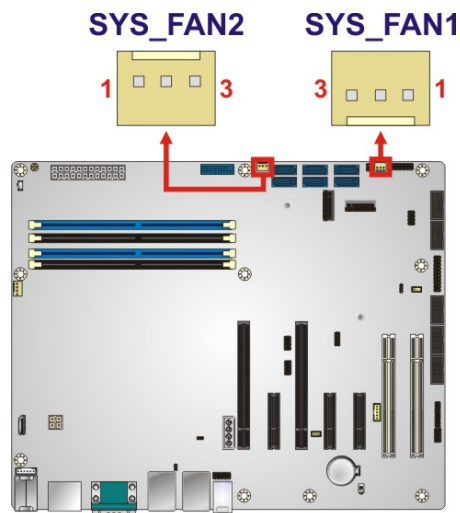

Figure 3-12: System Fan Connector Locations

Pin	Description
1	FANIO
2	PWM
3	GND

Table 3-10: System Fan (SYS_FAN1) Connector Pinouts

Pin	Description
1	NC
2	+12V
3	GND

Table 3-11: System Fan (SYS_FAN2) Connector Pinouts

3.2.5 Front Panel Audio Connector

- CN Label:** FRONT-PANEL1
- CN Type:** 10-pin header, p=2.54 mm
- CN Location:** See **Figure 3-13**
- CN Pinouts:** See **Table 3-12**

This connector connects to speakers, a microphone and an audio input.

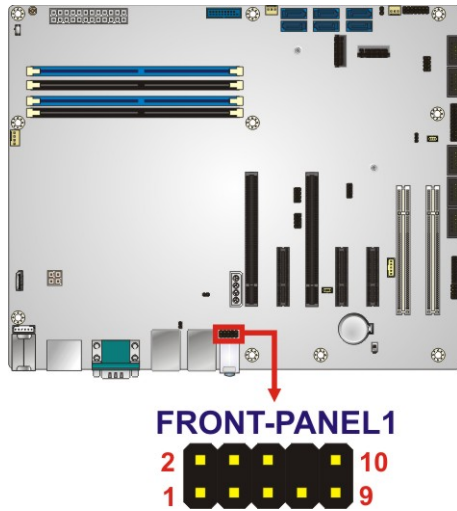

Figure 3-13: Front Panel Audio Connector Location

Pin	Description	Pin	Description
1	MIC2-L	2	GND
3	MIC2-R	4	Presence#
5	LINE2-R	6	MIC2-JD
7	FRONT-IO	8	NC
9	LINE2-L	10	LINE2-JD

Table 3-12: Front Panel Audio Connector Pinouts

IMBA-Q370 ATX Motherboard

3.2.6 Front Panel Connector

- CN Label:** F_PANEL1
- CN Type:** 14-pin header, p=2.54 mm
- CN Location:** See **Figure 3-14**
- CN Pinouts:** See **Table 3-13**

The front panel connector connects to the indicator LEDs and buttons on the computer's front panel.

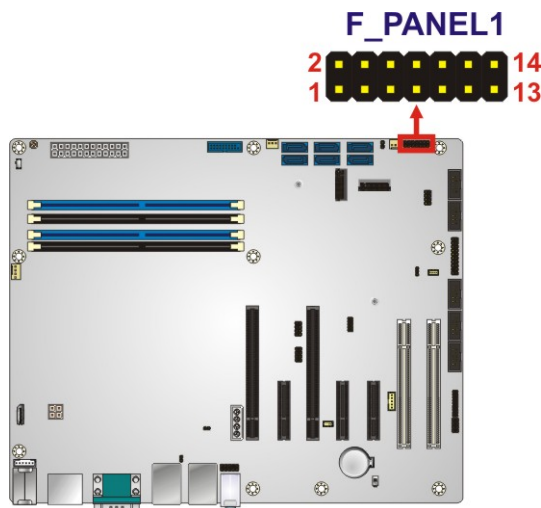

Figure 3-14: Front Panel Connector Location

Function	Pin	Description	Function	Pin	Description
Power/QTS LED	1	PWR_LED+	Speaker	2	SPKR+
	3	NC		4	-
	5	PWR_LED-		6	-
Power Button	7	PWR_BTN+	Speaker	8	SPKR-
	9	PWR_BTN-		10	NC
HDD LED	11	HDD_LED+	Reset	12	RESET+
	13	HDD_LED-		14	RESET-

Table 3-13: Front Panel Connector Pinouts

3.2.7 I²C Connector

- CN Label:** I2C1
- CN Type:** 4-pin wafer, p=1.25 mm
- CN Location:** See **Figure 3-15**
- CN Pinouts:** See **Table 3-14**

The I²C connector is used to connect I²C-bus devices to the mainboard.

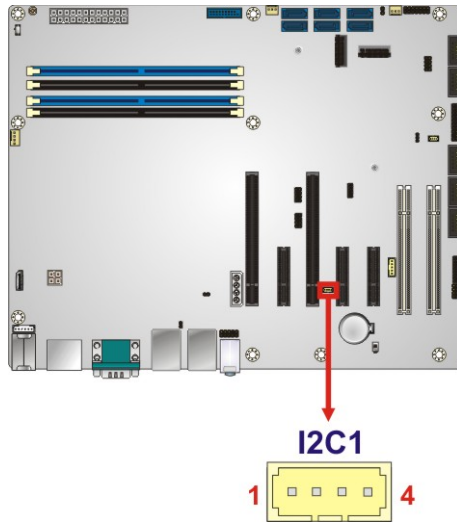

Figure 3-15: I²C Connector Location

Pin	Description
1	GND
2	I2C_DAT
3	I2C_CLK
4	+5V

Table 3-14: I²C Connector Pinouts

IMBA-Q370 ATX Motherboard

3.2.8 Keyboard and Mouse Connector

- CN Label:** KB_MS1
- CN Type:** 6-pin wafer, p=2 mm
- CN Location:** See **Figure 3-16**
- CN Pinouts:** See **Table 3-15**

The keyboard and mouse connector connects to a PS/2 Y-cable that can be connected to a PS/2 keyboard and mouse.

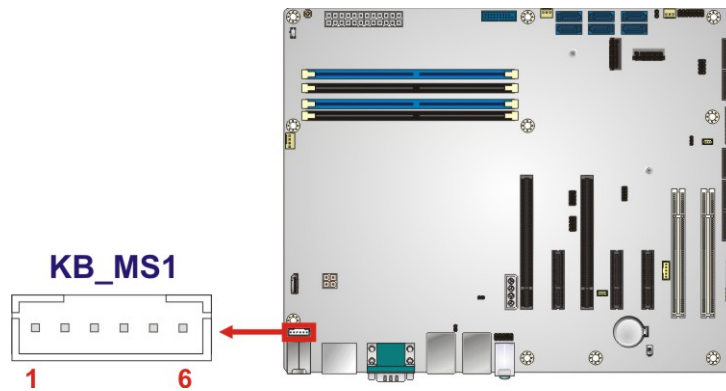

Figure 3-16: Keyboard and Mouse Connector Location

Pin	Description
1	VCC
2	Mouse Data
3	Mouse Clock
4	Keyboard Data
5	Keyboard Clock
6	GND

Table 3-15: Keyboard and Mouse Connector Pinouts

3.2.9 LAN LED Connectors

- CN Label:** LED_LAN1, LED_LAN2
- CN Type:** 2-pin header, p=2.54 mm
- CN Location:** See **Figure 3-17**
- CN Pinouts:** See **Table 3-16** and **Table 3-17**

The LAN LED connectors are used to connect to the LAN LED indicators on the chassis to indicate users the link activities of the two LAN ports.

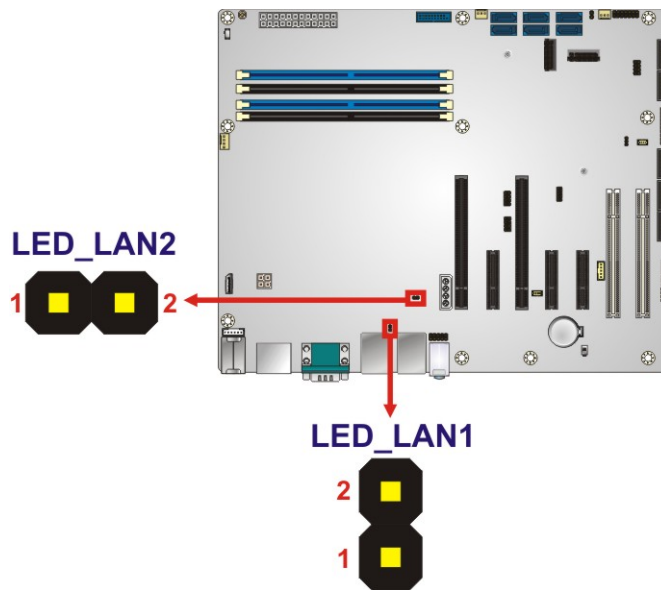

Figure 3-17: LAN LED Connector Locations

Pin	Description
1	+3.3V
2	LAN1_LED_LINK#_ACT

Table 3-16: LAN1 LED Connector (LED_LAN1) Pinouts

Pin	Description
1	+3.3V
2	LAN2_LED_LINK#_ACT

Table 3-17: LAN2 LED Connector (LED_LAN2) Pinouts

IMBA-Q370 ATX Motherboard

3.2.10 M.2 2230 Slot, A-Key

- CN Label:** M2_A1
- CN Type:** M.2 A-key slot
- CN Location:** See **Figure 3-18**
- CN Pinouts:** See **Table 3-18**

The M.2 2230 slot is keyed in the A position. The M.2 slot supports PCIe x1 and USB 2.0 interfaces.

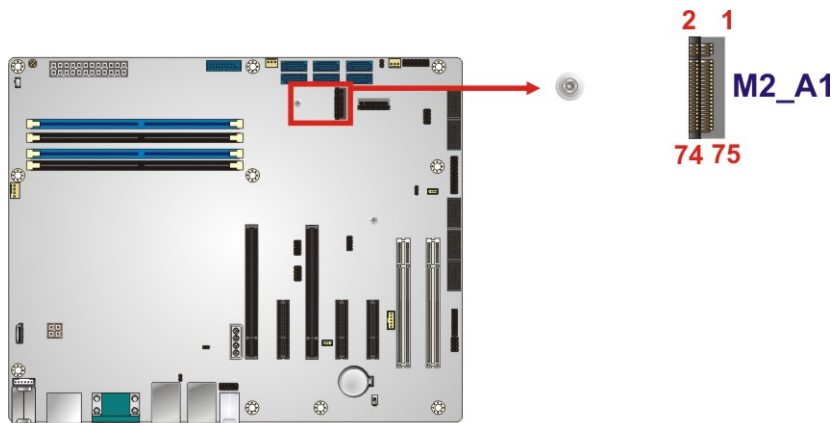

Figure 3-18: M.2 2230 Slot Location

Pin	Description	Pin	Description
1	GND	2	+3.3V
3	USB2_DP	4	+3.3V
5	USB2_DN	6	NC
7	GND	8	NC
9	NC	10	NC
11	NC	12	NC
13	NC	14	NC
15	NC	16	NC
17	NC	18	GND
19	NC	20	NC
21	NC	22	NC
23	GND	24	GND

Pin	Description	Pin	Description
25	NC	26	NC
27	NC	28	NC
29	GND	30	GND
31	NC	32	NC
33	GND	34	NC
35	PETP0	36	GND
37	PETN0	38	NC
39	GND	40	NC
41	PERP0	42	NC
43	PERN0	44	NC
45	GND	46	NC
47	PCIE_CLK+	48	NC
49	PCIE_CLK-	50	NC
51	GND	52	PLT_RST
53	NC	54	NC
55	PCIE_WAKE	56	W_DIS
57	GND	58	NC
59	NC	60	NC
61	NC	62	NC
63	GND	64	NC
65	NC	66	NC
67	NC	68	CLK_REQ
69	GND	70	+3.3V
71	NC	72	+3.3V
73	NC	74	+3.3V
75	GND		

Table 3-18: M.2 2230 Connector Pinouts

IMBA-Q370 ATX Motherboard

3.2.11 M.2 2280 Slot, M-Key

- CN Label:** M2_M1
- CN Type:** M.2 M-key slot
- CN Location:** See **Figure 3-19**
- CN Pinouts:** See **Table 3-19**

The M.2 2280 slot is keyed in the B position. The M.2 slot supports PCIe x2 interfaces.

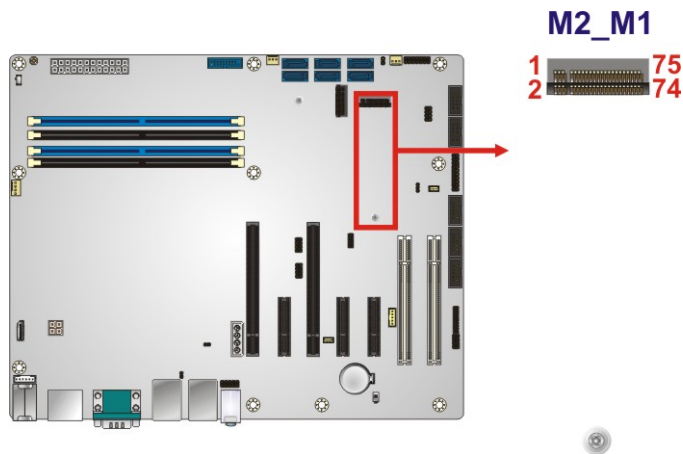

Figure 3-19: M.2 2280 Slot Location

Pin	Description	Pin	Description
1	GND	2	+3.3V
3	USB2_DP	4	+3.3V
5	USB2_DN	6	NC
7	GND	8	NC
9	NC	10	NC
11	NC	12	NC
13	NC	14	NC
15	NC	16	NC
17	NC	18	GND
19	NC	20	NC
21	NC	22	NC
23	GND	24	GND

Pin	Description	Pin	Description
25	NC	26	NC
27	NC	28	NC
29	GND	30	GND
31	NC	32	NC
33	GND	34	NC
35	PETP0	36	GND
37	PETN0	38	NC
39	GND	40	NC
41	PERP0	42	NC
43	PERN0	44	NC
45	GND	46	NC
47	PCIE_CLK+	48	NC
49	PCIE_CLK-	50	NC
51	GND	52	PLT_RST
53	NC	54	NC
55	PCIE_WAKE	56	W_DIS
57	GND	58	NC
59	NC	60	NC
61	NC	62	NC
63	GND	64	NC
65	NC	66	NC
67	NC	68	CLK_REQ
69	GND	70	+3.3V
71	NC	72	+3.3V
73	NC	74	+3.3V
75	GND		

Table 3-19: M.2 2280 Connector Pinouts

IMBA-Q370 ATX Motherboard

3.2.12 PCI Slots

- CN Label:** PCI1, PCI2
CN Type: PCI Slot
CN Location: See **Figure 3-20**

The PCI slot enables a PCI expansion module to be connected to the board.

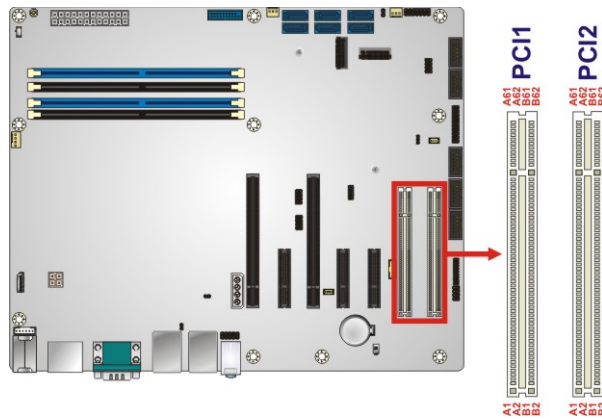

Figure 3-20: PCI Slot Locations

3.2.13 PCIe x4 Slots

- CN Label:** PCIEX4_1, PCIEX4_2, PCIEX4_3
CN Type: PCIe x4 slot
CN Location: See **Figure 3-21**

The PCIe x4 expansion card slots are for PCIe x4 expansion cards.

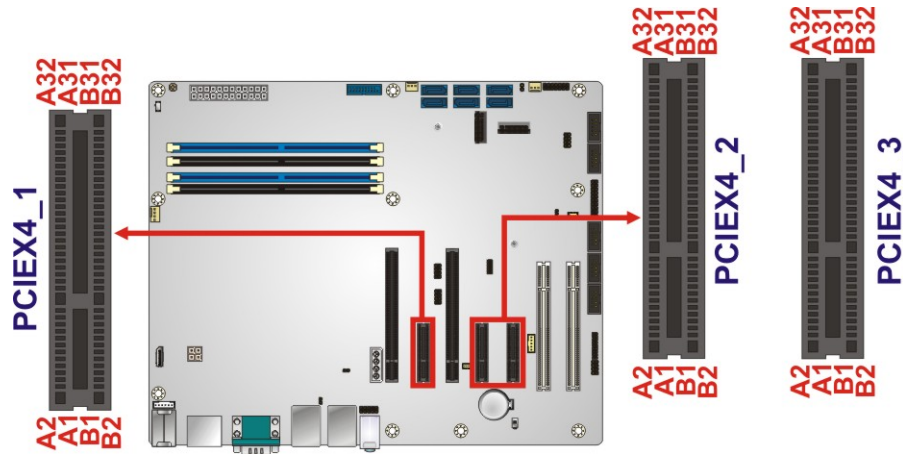

Figure 3-21: PCIe x4 Slot Locations

3.2.14 PCIe x8 Slots

CN Label: PCIEX8_1, PCIEX8_2

CN Type: PCIe x16 slot (x8 mode)

CN Location: See **Figure 3-22**

The PCIe x8 expansion card slots are for PCIe x8 expansion cards.

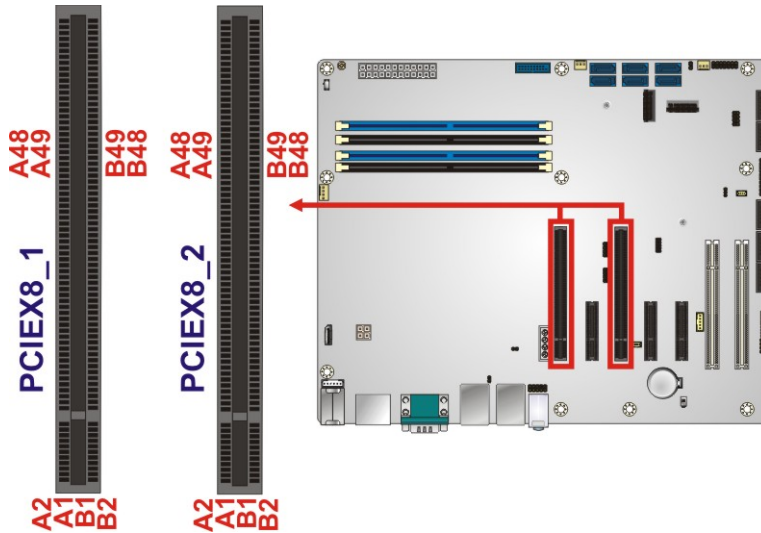

Figure 3-22: PCIe x8 Slot Locations

IMBA-Q370 ATX Motherboard

3.2.15 Power Button

- CN Label:** PWR_SW1
CN Type: Push button
CN Location: See **Figure 3-23**

The on-board power button controls system power.

PWR_SW1

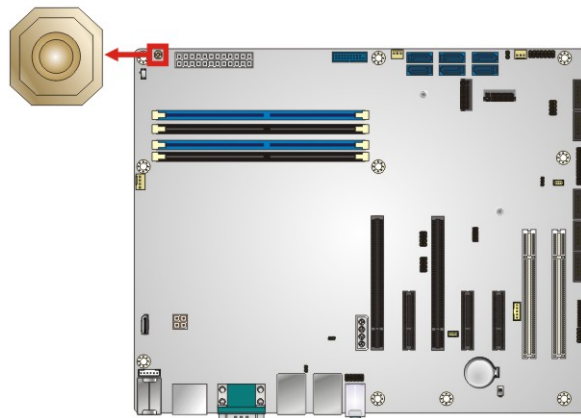

Figure 3-23: Power Button Location

3.2.16 SATA 6Gb/s Drive Connector

CN Label: S_ATA1, S_ATA2, S_ATA3, S_ATA4, S_ATA5, S_ATA6

CN Type: 7-pin SATA drive connector

CN Location: See **Figure 3-24**

CN Pinouts: See **Table 3-20**

The SATA drive connectors can be connected to SATA drives and support up to 6Gb/s data transfer rate.

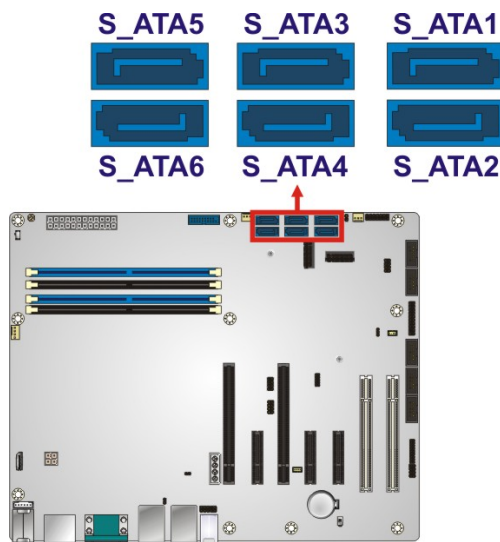

Figure 3-24: SATA 6Gb/s Drive Connector Locations

Pin	Description
1	GND
2	SATA_TX+
3	SATA_TX-
4	GND
5	SATA_RX-
6	SATA RX+
7	GND

Table 3-20: SATA 6Gb/s Drive Connector Pinouts

IMBA-Q370 ATX Motherboard

3.2.17 Serial Port Connectors, RS-232

- CN Label:** COM2, COM3, COM4
- CN Type:** 10-pin box header, p=2.54 mm
- CN Location:** See **Figure 3-25**
- CN Pinouts:** See **Table 3-21**

Each of these connectors provides RS-232 connections.

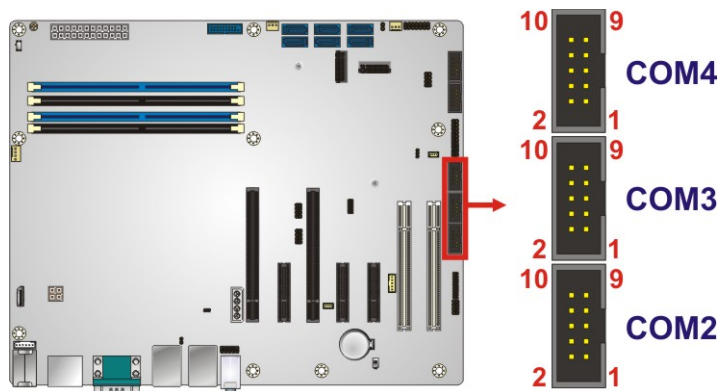

Figure 3-25: RS-232 Serial Port Connector Location

Pin	Description	Pin	Description
1	DCD	2	DSR
3	RXD	4	RTS
5	TXD	6	CTS
7	DTR	8	RI
9	GND	10	GND

Table 3-21: RS-232 Serial Port Connector Pinouts

3.2.18 Serial Port Connectors, RS-232/422/485

- CN Label:** COM5, COM6
- CN Type:** 10-pin box header, p=2.54 mm
- CN Location:** See **Figure 3-26**
- CN Pinouts:** See **Table 3-22**

Each of these connectors provides RS-232, RS-422 or RS-485 communications. The communication protocol of the serial ports is set through the BIOS menu in “**Advanced → F81866 Super IO Configuration → Serial Port 5/6 Configuration**”. Use the Transfer Mode BIOS option to configure the correspondent serial ports (refer to **Sections 5.3.6.6** and **5.3.6.7** for detailed information).

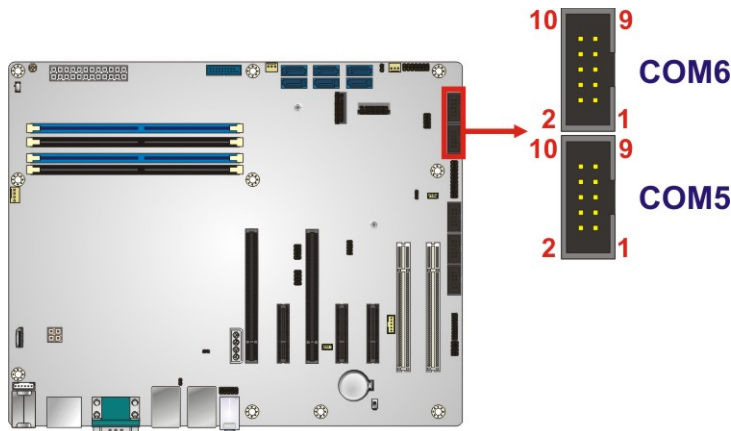

Figure 3-26: RS-232/422/485 Connector Location

Pin	Description	Pin	Description
1	DCD	2	DSR
3	RXD	4	RTS
5	TXD	6	CTS
7	DTR	8	RI
9	GND	10	GND

Table 3-22: RS-232/422/485 Connector Pinouts

IMBA-Q370 ATX Motherboard

Use the optional RS-232/422/485 cable to connect to a serial device. The pinouts of the DB-9 connector are listed below.

RS-232 Pinouts	RS-422 Pinouts	RS-485 Pinouts
		

Table 3-23: DB-9 RS-232/422/485 Pinouts

3.2.19 SMBus Connector

- CN Label:** SMB1
- CN Type:** 4-pin wafer, p=1.25 mm
- CN Location:** See Figure 3-27
- CN Pinouts:** See Table 3-24

The SMBus (System Management Bus) connector provides low-speed system management communications.

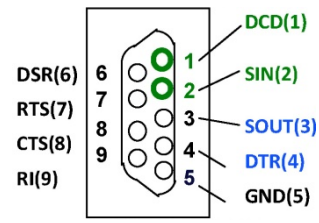
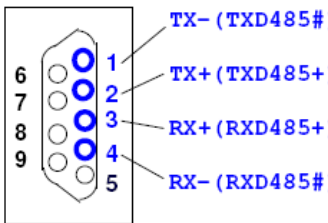
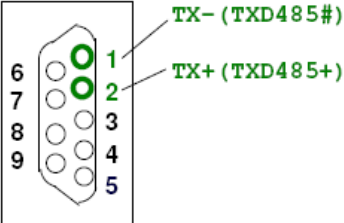
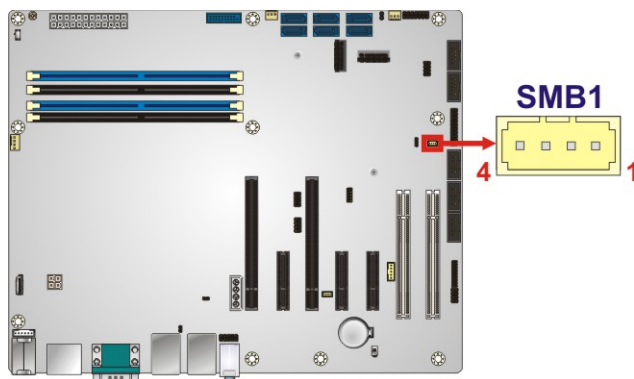

Figure 3-27: SMBus Connector Location

Pin	Description
1	GND
2	SMB_DATA
3	SMB_CLK
4	+5V

Table 3-24: SMBus Connector Pinouts

3.2.20 SPI Flash Connector

- CN Label:** JSPI1
- CN Type:** 8-pin header, p=2.54 mm
- CN Location:** See **Figure 3-28**
- CN Pinouts:** See **Table 3-25**

The SPI flash connector is used to flash the SPI ROM.

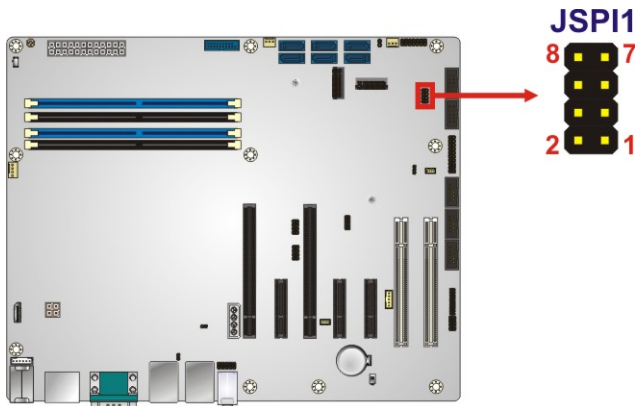

Figure 3-28: SPI Flash Connector Location

Pin	Description	Pin	Description
1	+3.3V	2	GND
3	SPI_CS	4	SPI_CLK
5	SPI_SO	6	SPI_SI
7	NC	8	NC

Table 3-25: SPI Flash Connector Pinouts

IMBA-Q370 ATX Motherboard

3.2.21 SPI Flash Connector, EC

- CN Label:** JSPI2
- CN Type:** 8-pin header, p=2.54 mm
- CN Location:** See **Figure 3-29**
- CN Pinouts:** See **Table 3-26**

The SPI flash connector is used to flash the EC ROM.

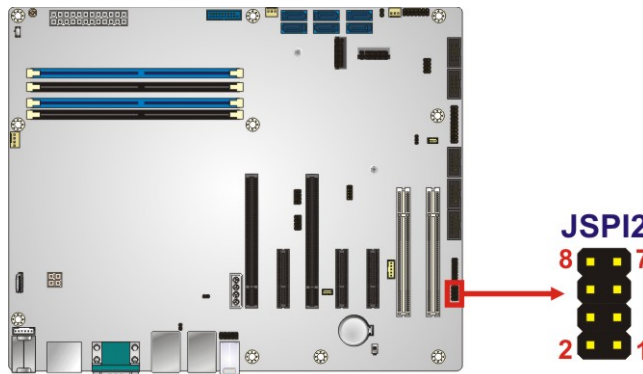

Figure 3-29: SPI EC Flash Connector Location

Pin	Description	Pin	Description
1	+3.3V	2	GND
3	SPI_CS	4	SPI_CLK
5	SPI_SO	6	SPI_SI
7	NC	8	NC

Table 3-26: SPI EC Flash Connector Pinouts

3.2.22 TPM Connector

- CN Label:** TPM1
- CN Type:** 20-pin header, p=2.54 mm
- CN Location:** See **Figure 3-30**
- CN Pinouts:** See **Table 3-27**

The TPM connector connects to a TPM module.

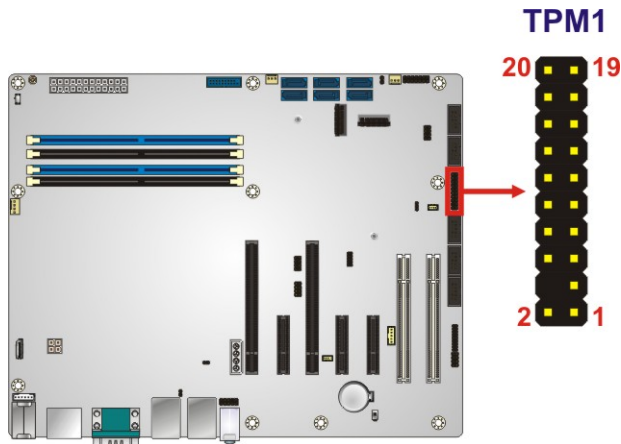

Figure 3-30: TPM Connector Location

Pin	Description	Pin	Description
1	LCLK	2	GND
3	LFRAME#	4	KEY
5	LRERST#	6	+5V
7	LAD3	8	LAD2
9	+3.3V	10	LAD1
11	LAD0	12	GND
13	SCL	14	SDA
15	SB3V	16	SERIRQ
17	GND	18	GLKRUN#
19	LPCPD#	20	LDRQ#

Table 3-27: TPM Connector Pinouts

IMBA-Q370 ATX Motherboard

3.2.23 USB 2.0 Connectors

- CN Label:** USB1, USB2
- CN Type:** 8-pin header, p=2.54 mm
- CN Location:** See **Figure 3-31**
- CN Pinouts:** See **Table 3-28**

The USB 2.0 connectors connect to USB 2.0 devices. Each pin header provides two USB 2.0 ports.

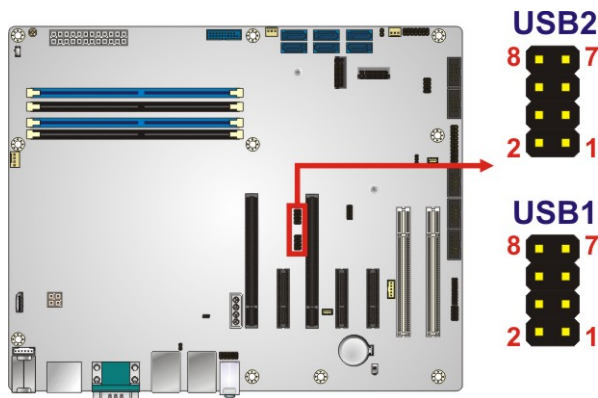

Figure 3-31: USB 2.0 Connector Pinout Locations

Pin	Description	Pin	Description
1	VCC	2	GND
3	USB_DATA-	4	USB_DATA+
5	USB_DATA+	6	USB_DATA-
7	GND	8	VCC

Table 3-28: USB 2.0 Connector Pinouts

3.2.24 USB 3.2 Gen 1 Connector

- CN Label:** USB3-1
- CN Type:** 19-pin box header, p=2 mm
- CN Location:** See **Figure 3-32**
- CN Pinouts:** See **Table 3-29**

The USB 3.2 Gen 1 (5Gb/s) connector connects to USB 3.2 devices. This connector provides two USB 3.2 Gen 1 (5Gb/s) ports.

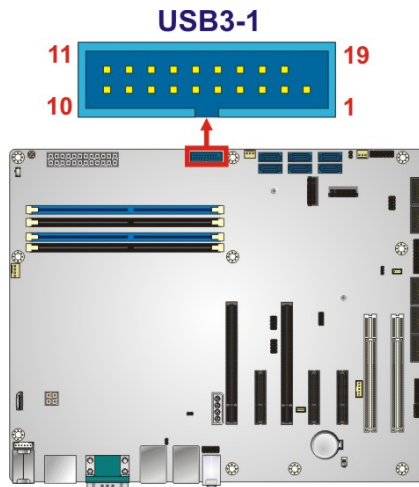

Figure 3-32: USB 3.2 Gen 1 Connector Location

Pin	Description	Pin	Description
1	VCC	11	USB_DATA+
2	USB3_RX-	12	USB_DATA-
3	USB3_RX+	13	GND
4	GND	14	USB3_TX+
5	USB3_TX-	15	USB3_TX-
6	USB3_TX+	16	GND
7	GND	17	USB3_RX+
8	USB_DATA-	18	USB3_RX-
9	USB_DATA+	19	VCC
10	NC		

Table 3-29: USB 3.2 Gen 1 Connector Pinouts

IMBA-Q370 ATX Motherboard

3.3 External Peripheral Interface Connector Panel

The figure below shows the external peripheral interface connector (EPIC) panel. The EPIC panel consists of the following:

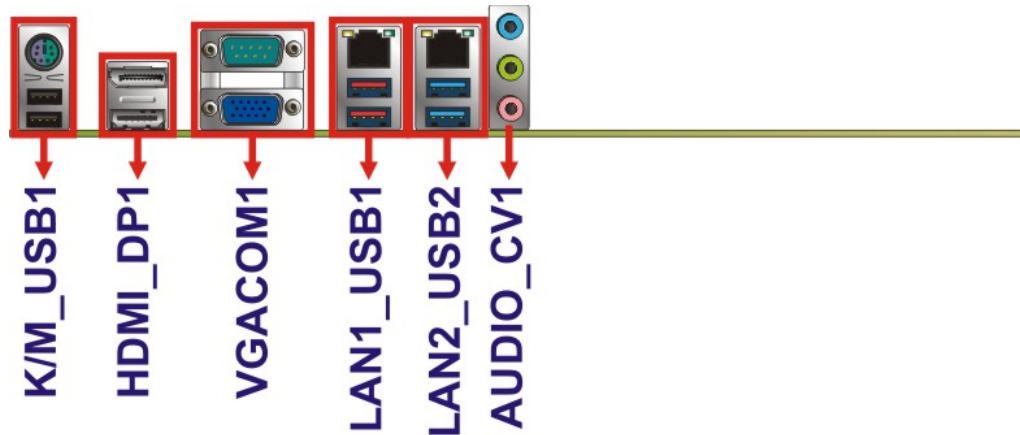

Figure 3-33: External Peripheral Interface Connector

3.3.1 Audio Connector

CN Label:	AUDIO_CV1
CN Type:	Audio jack
CN Location:	See Figure 3-33

The audio jacks connect to external audio devices.

- **Line In port (Light Blue):** Connects a CD-ROM, DVD player, or other audio devices.
- **Line Out port (Lime):** Connects to a headphone or a speaker. With multi-channel configurations, this port can also connect to front speakers.
- **Microphone (Pink):** Connects a microphone.

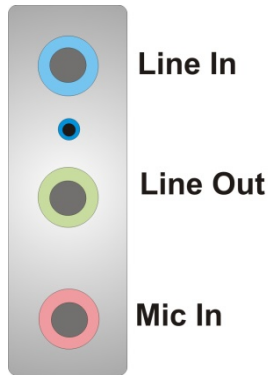

Figure 3-34: Audio Connector

3.3.2 Ethernet and USB 3.2 Connectors

- CN Label:** LAN1_USB1, LAN2_USB2
- CN Type:** RJ-45, USB 3.2 Type A
- CN Location:** See **Figure 3-33**
- CN Pinouts:** See **Table 3-30** and **Table 3-31**

There are four external USB 3.2 connectors on the IMBA-Q370. The LAN1_USB1 connector supports USB 3.2 Gen 2 (10Gb/s) connection while the LAN2_USB2 connector supports USB 3.2 Gen 1 (5Gb/s) connection.

Pin	Description	Pin	Description
1	VCC	10	VCC
2	USB_DATA-	11	USB_DATA-
3	USB_DATA+	12	USB_DATA+
4	GND	13	GND
5	USB3_RX-	14	USB3_RX-
6	USB3_RX+	15	USB3_RX+
7	GND	16	GND
8	USB3_TX-	17	USB3_TX-
9	USB3_TX+	18	USB3_TX+

Table 3-30: USB 3.2 Port Pinouts

IMBA-Q370 ATX Motherboard

Each LAN connector connects to a local network

Pin	Description	Pin	Description
20	LAN1_MDI0P	24	LAN1_MDI2P
21	LAN1_MDI0N	25	LAN1_MDI2N
22	LAN1_MDI1P	26	LAN1_MDI3P
23	LAN1_MDI1N	27	LAN1_MDI3N

Table 3-31: LAN Pinouts

3.3.3 HDMI and DP++ Connector

CN Label: HDMI_DP1

CN Type: HDMI, DisplayPort

CN Location: See **Figure 3-33**

CN Pinouts: See **Table 3-32** and **Table 3-33**

The HDMI connector can connect to an HDMI device.

Pin	Description	Pin	Description
1	HDMI_DATA2	2	GND
3	HDMI_DATA2#	4	HDMI_DATA1
5	GND	6	HDMI_DATA1#
7	HDMI_DATA0	8	GND
9	HDMI_DATA0#	10	HDMI_CLK
11	GND	12	HDMI_CLK#
13	N/C	14	N/C
15	HDMI_SCL	16	HDMI_SDA
17	GND	18	+5V
19	HDMI_HPD	20	HDMI_GND
21	HDMI_GND	22	HDMI_GND
23	HDMI_GND		

Table 3-32: HDMI Connector Pinouts

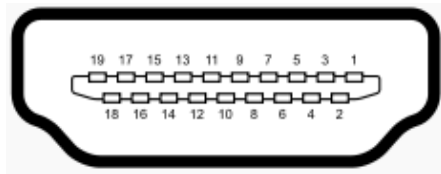

Figure 3-35: HDMI Connector

The DP++ connector connects to a display device with DisplayPort interface.

Pin	Description	Pin	Description
1	HDMI_DATA2	13	NC
2	GND	14	NC
3	HDMI_DATA2#	15	HDMI_SCL
4	HDMI_DATA1	16	HDMI_SDA
5	GND	17	GND
6	HDMI_DATA1#	18	+5V
7	HDMI_DATA0	19	HDMI_HPD
8	GND	20	HDMI_GND
9	HDMI_DATA0#	21	HDMI_GND
10	HDMI_CLK	22	HDMI_GND
11	GND	23	HDMI_GND
12	HDMI_CLK#		

Table 3-33: DP++ Connector Pinouts

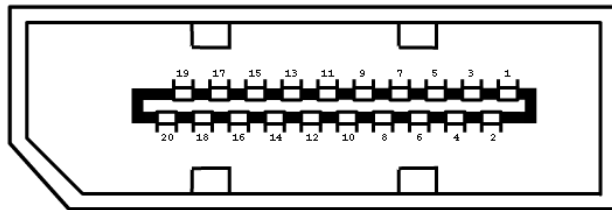

Figure 3-36: HDMI Connector

IMBA-Q370 ATX Motherboard

3.3.4 Keyboard/Mouse and USB 2.0 Connectors

CN Label: K/M_USB1

CN Type: PS/2, USB 2.0

CN Location: See **Figure 3-33**

CN Pinouts: See **Table 3-34** and **Table 3-35**

The USB 2.0 connector can be connected to a USB 2.0/1.1 device.

Pin	Description	Pin	Description
1	VCC	5	VCC
2	USB_DATA-	6	USB_DATA-
3	USB_DATA+	7	USB_DATA+
4	GND	8	GND

Table 3-34: USB 2.0 Port Pinouts

The PS/2 port is for connecting a PS/2 mouse or keyboard.

Pin	Description
9	GND
10	Keyboard Data
11	Mouse Data
12	VCC
13	Keyboard Clock
14	Mouse Clock

Table 3-35: PS/2 Connector Pinouts

3.3.5 VGA and RS-232 Connectors

- CN Label:** VGACOM1
- CN Type:** 15-pin VGA and 9-pin COM
- CN Location:** See **Figure 3-33**
- CN Pinouts:** See **Table 3-36** and **Table 3-37**

The COM connector (COM1) connects to a serial device that supports RS-232 communication.

Pin	Description	Pin	Description
1	DCD	6	DSR
2	RX	7	RTS
3	TX	8	CTS
4	DTR	9	RI
5	GND		

Table 3-36: COM1 Connector Pinouts

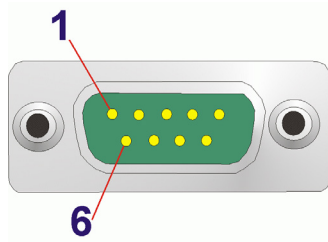

Figure 3-37: COM1 Serial Port Pinout Locations

IMBA-Q370 ATX Motherboard

The 15-pin VGA connector connects to a monitor that accepts a standard VGA input.



NOTE:

The user has to connect the VGA connector to the monitor before system booting as the VGA output function is supported via the eDP to VGA converter.

Pin	Description	Pin	Description
1	RED	2	GREEN
3	BLUE	4	NC
5	GND	6	HOT PLUG DETECT
7	GND	8	GND
9	VCC	10	GND
11	NC	12	DCCDA
13	HSYNC	14	VSYNC
15	DDCCLK		

Table 3-37: VGA Connector Pinouts

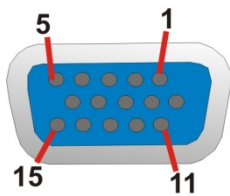

Figure 3-38: VGA Connector

Chapter

4

Installation

IMBA-Q370 ATX Motherboard

4.1 Anti-static Precautions



WARNING:

Failure to take ESD precautions during the installation of the IMBA-Q370 may result in permanent damage to the IMBA-Q370 and severe injury to the user.

Electrostatic discharge (ESD) can cause serious damage to electronic components, including the IMBA-Q370. Dry climates are especially susceptible to ESD. It is therefore critical that whenever the IMBA-Q370 or any other electrical component is handled, the following anti-static precautions are strictly adhered to.

- **Wear an anti-static wristband:** - Wearing a simple anti-static wristband can help to prevent ESD from damaging the board.
- **Self-grounding:**- Before handling the board touch any grounded conducting material. During the time the board is handled, frequently touch any conducting materials that are connected to the ground.
- **Use an anti-static pad:** When configuring the IMBA-Q370, place it on an anti-static pad. This reduces the possibility of ESD damaging the IMBA-Q370.
- **Only handle the edges of the PCB:-:** When handling the PCB, hold the PCB by the edges.

4.2 Installation Considerations



NOTE:

The following installation notices and installation considerations should be read and understood before installation. All installation notices must be strictly adhered to. Failing to adhere to these precautions may lead to severe damage and injury to the person performing the installation.

**WARNING:**

The installation instructions described in this manual should be carefully followed in order to prevent damage to the components and injury to the user.

Before and during the installation please **DO** the following:

- Read the user manual:
 - The user manual provides a complete description of the IMBA-Q370 installation instructions and configuration options.
- Wear an electrostatic discharge cuff (ESD):
 - Electronic components are easily damaged by ESD. Wearing an ESD cuff removes ESD from the body and helps prevent ESD damage.
- Place the IMBA-Q370 on an anti-static pad:
 - When installing or configuring the motherboard, place it on an anti-static pad. This helps to prevent potential ESD damage.
- Turn all power to the IMBA-Q370 off:
 - When working with the IMBA-Q370, make sure that it is disconnected from all power supplies and that no electricity is being fed into the system.

Before and during the installation of the IMBA-Q370, **DO NOT**:

- Remove any of the stickers on the PCB board. These stickers are required for warranty validation.
- Use the product before verifying all the cables and power connectors are properly connected.
- Allow screws to come in contact with the PCB circuit, connector pins, or its components.

IMBA-Q370 ATX Motherboard

4.3 Socket LGA1151 CPU Installation

**WARNING:**

CPUs are expensive and sensitive components. When installing the CPU please be careful not to damage it in anyway. Make sure the CPU is installed properly and ensure the correct cooling kit is properly installed.

DO NOT touch the pins at the bottom of the CPU. When handling the CPU, only hold it on the sides.

To install the CPU, follow the steps below.

Step 1: **Disengage the load lever** by pressing the lever down and slightly outward to clear the retention tab. Fully open the lever. See **Figure 4-1**.

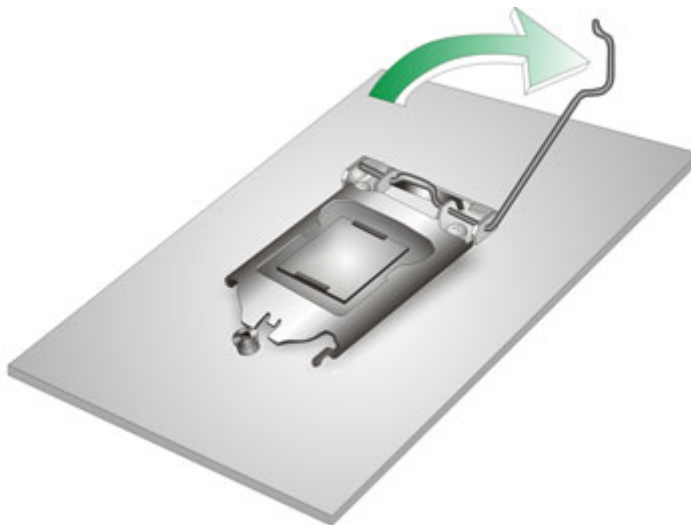

Figure 4-1: Disengage the CPU Socket Load Lever

Step 2: **Open the socket and remove the protective cover.** The black protective cover can be removed by pulling up on the tab labeled "Remove". See **Figure 4-2**.

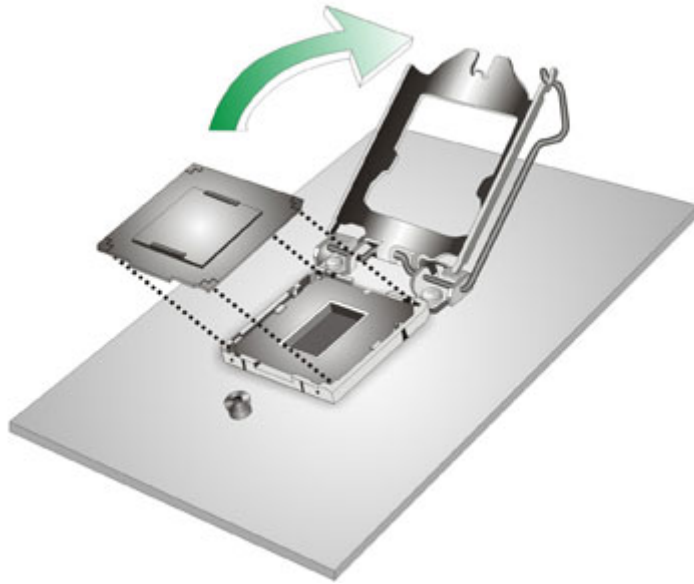

Figure 4-2: Remove Protective Cover

- Step 3: Inspect the CPU socket.** Make sure there are no bent pins and make sure the socket contacts are free of foreign material. If any debris is found, remove it with compressed air.
- Step 4: Orientate the CPU properly.** The contact array should be facing the CPU socket.



WARNING:

DO NOT touch the pins at the bottom of the CPU. When handling the CPU, only hold it on the sides.

-
- Step 5: Correctly position the CPU.** Match the Pin 1 mark with the cut edge on the CPU socket.
- Step 6: Align the CPU pins.** Locate pin 1 and the two orientation notches on the CPU. Carefully match the two orientation notches on the CPU with the socket alignment keys.

IMBA-Q370 ATX Motherboard

Step 7: Insert the CPU. Gently insert the CPU into the socket. If the CPU pins are properly aligned, the CPU should slide into the CPU socket smoothly. See

Figure 4-3.

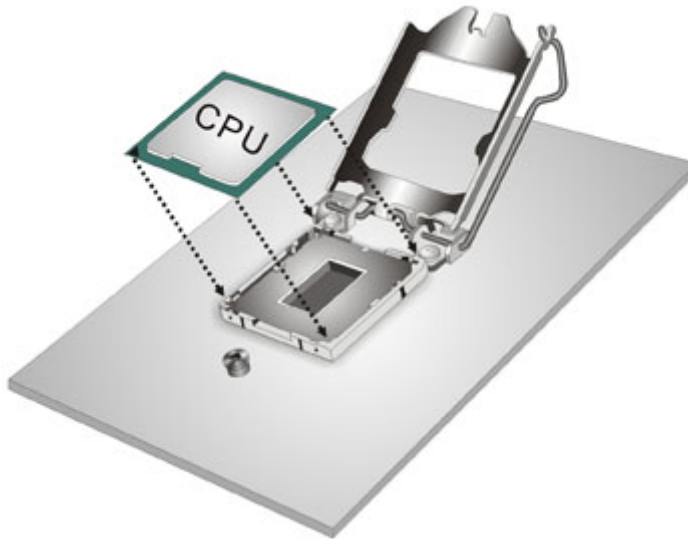

Figure 4-3: Insert the Socket LGA1151 CPU

Step 8: Close the CPU socket. Close the load plate and pull the load lever back a little to have the load plate be able to secure to the knob. Engage the load lever by pushing it back to its original position (**Figure 4-4**). There will be some resistance, but will not require extreme pressure.

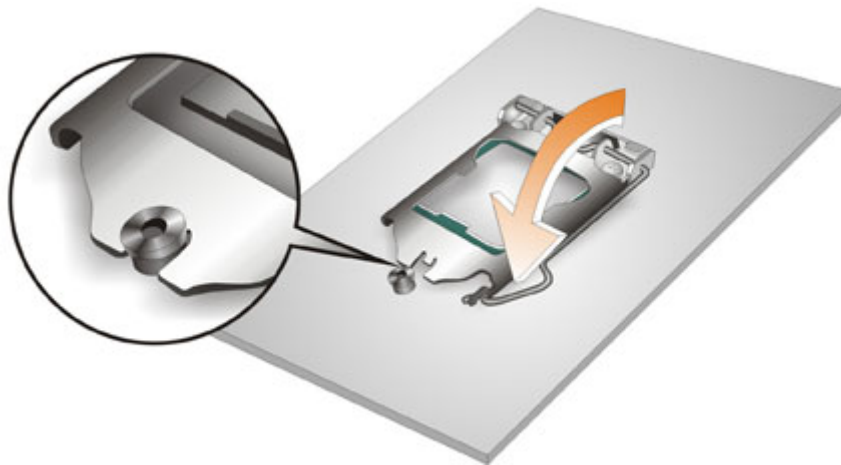

Figure 4-4: Close the Socket LGA1151

Step 9: Connect the 12 V power to the board. Connect the 12 V power from the power supply to the board.

4.4 Socket LGA1151 Cooling Kit Installation



WARNING:

DO NOT attempt to install a push-pin cooling fan.

The pre-installed support bracket prevents the board from bending and is **ONLY** compatible with captive screw type cooling fans.

The cooling kit can be bought from IEI. The cooling kit has a heat sink and fan.



WARNING:

Do not wipe off (accidentally or otherwise) the pre-sprayed layer of thermal paste on the bottom of the heat sink. The thermal paste between the CPU and the heat sink is important for optimum heat dissipation.

To install the cooling kit, follow the instructions below.

Step 1: A cooling kit bracket is pre-installed on the rear of the motherboard. See **Figure 4-5**.

IMBA-Q370 ATX Motherboard

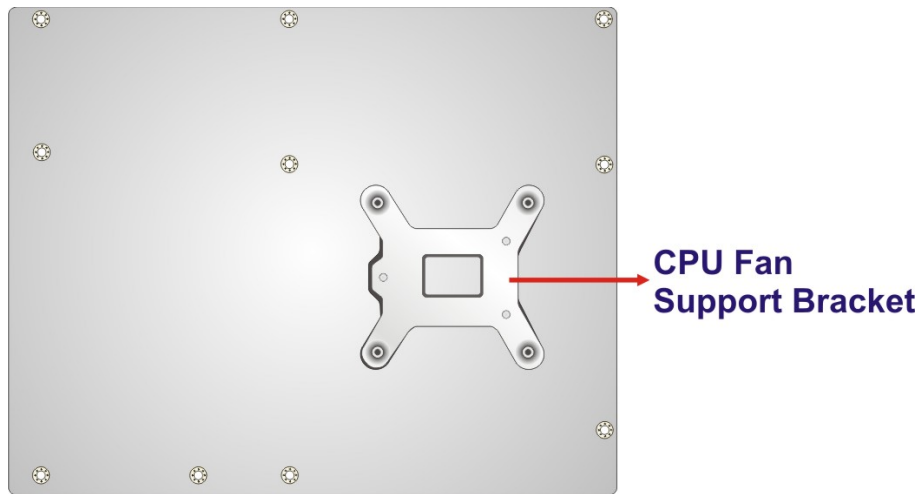

Figure 4-5: Cooling Kit Support Bracket

- Step 2:** Place the cooling kit onto the socket LGA1151 CPU. Make sure the CPU cable can be properly routed when the cooling kit is installed.
- Step 3:** Mount the cooling kit. Gently place the cooling kit on top of the CPU. Make sure the four threaded screws on the corners of the cooling kit properly pass through the holes of the cooling kit bracket.
- Step 4:** Tighten the screws. Use a screwdriver to tighten the four screws. In a diagonal pattern, tighten each screw a few turns then move to the next one, until they are all secured. Do not overtighten the screws.
- Step 5:** Connect the fan cable. Connect the cooling kit fan cable to the CPU fan connector on the IMBA-Q370. Carefully route the cable and avoid heat generating chips and fan blades.

4.5 DIMM Installation

To install a DIMM, please follow the steps below and refer to **Figure 4-6**.

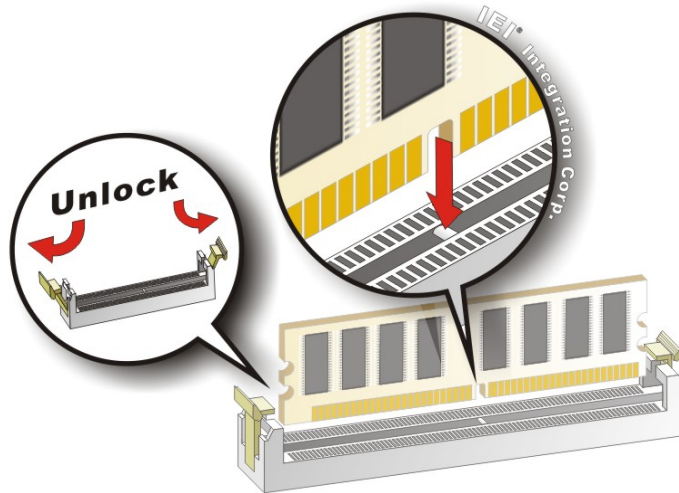

Figure 4-6: DIMM Installation

- Step 1: Open the DIMM socket handles.** Open the two handles outwards as far as they can. See **Figure 4-6**.
- Step 2: Align the DIMM with the socket.** Align the DIMM so the notch on the memory lines up with the notch on the memory socket. See **Figure 4-6**.
- Step 3: Insert the DIMM.** Once aligned, press down until the DIMM is properly seated. Clip the two handles into place. See **Figure 4-6**.
- Step 4: Removing a DIMM.** To remove a DIMM, push both handles outward. The memory module is ejected by a mechanism in the socket.



CAUTION:

For quad channel configuration, install four identical memory modules that feature the same capacity, timings, voltage, number of ranks and the same brand.

IMBA-Q370 ATX Motherboard

4.6 System Configuration

The system configuration is controlled by jumpers, buttons, switches and BIOS options. The system configuration must be performed before installation.

4.6.1 AT/ATX Power Mode Setting

The AT and ATX power mode selection is made through the AT/ATX power mode switch which is shown in **Figure 4-7**.

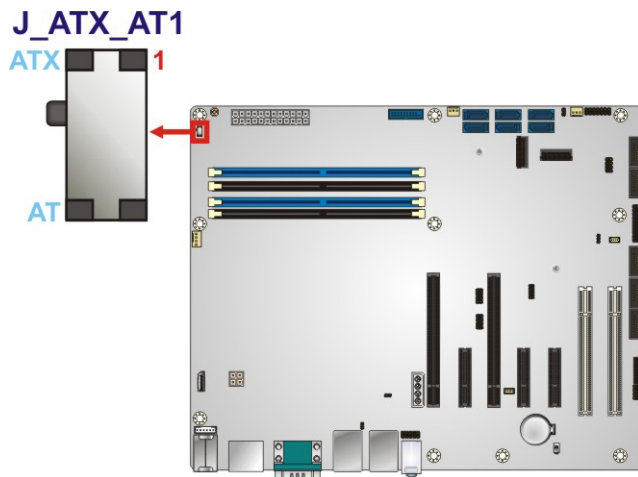

Figure 4-7: AT/ATX Power Mode Switch Location

Setting	Description
1-2	ATX power mode (default)
2-3	AT power mode

Table 4-1: AT/ATX Power Mode Switch Settings

4.6.2 Clearing CMOS

To reset the BIOS, remove the on-board battery and press the **J_CMOS1** button for three seconds or more. The clear CMOS button is shown in **Figure 4-8**.

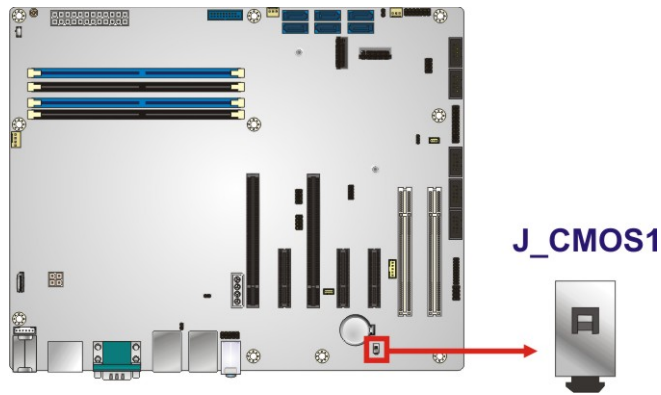

Figure 4-8: Clear CMOS Button and Header Locations

4.6.3 Flash Descriptor Security Override Jumper

The flash descriptor security override jumper (J_FLASH1) allows to enable or disable the ME firmware update. Refer to **Table 4-2** and **Figure 4-9** for the jumper location and settings.

Setting	Description
Short 1-2	Disabled (default)
Short 2-3	Enabled

Table 4-2: Flash Descriptor Security Override Jumper Settings

IMBA-Q370 ATX Motherboard

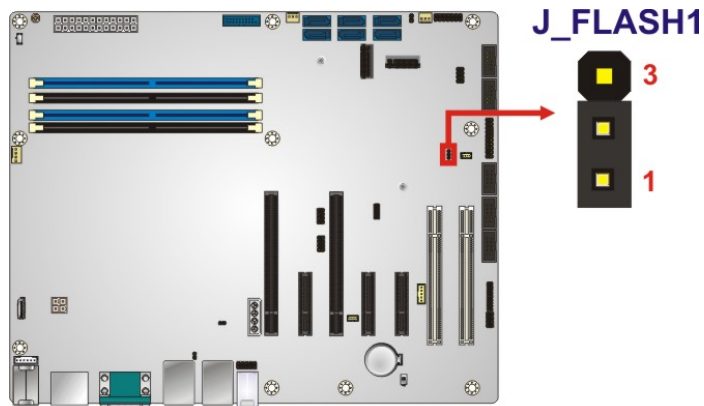

Figure 4-9: Flash Descriptor Security Override Jumper Location

To update the ME firmware, please follow the steps below.

- Step 1:** Before turning on the system power, short pin 2-3 of the flash descriptor security override jumper.
- Step 2:** Update the BIOS and ME firmware, and then turn off the system power.
- Step 3:** Remove the metal clip on the flash descriptor security override jumper or return to its default setting (short pin 1-2).
- Step 4:** Restart the system. The system will reboot 2 ~ 3 times to complete the ME firmware update.

4.6.4 USB Power Selection

The USB power selection is made through the BIOS menu in “Chipset → PCH-IO Configuration”. Use the **USB Power SW1** and the **USB Power SW2** BIOS options to configure the correspondent USB ports (see **Table 4-3**) and refer to **Table 4-4** to select the USB power source.

BIOS Options	Configured USB Ports
USB Power SW1	K/M_USB1 (external USB 2.0 ports) LAN1_USB1 (external USB 3.2 Gen 2 ports) LAN2_USB2 (external USB 3.2 Gen 1 ports)
USB Power SW2	USB1 (internal USB 2.0 ports) USB2 (internal USB 2.0 ports) USB3-1 (internal USB 3.2 Gen 1 ports)

Table 4-3: BIOS Options and Configured USB Ports

Options	Description
+5V DUAL	+5V dual (default)
+5V	+5V

Table 4-4: USB Power Source Setup

Please refer to **Section 5.4.1.3.1** for BIOS setup.

4.7 Internal Peripheral Device Connections

This section outlines the installation of peripheral devices to the onboard connectors.

4.7.1 SATA Drive Connection

The IMBA-Q370 is shipped with two SATA drive cables. To connect the SATA drives to the connectors, please follow the steps below.

Step 1: Locate the connectors. The locations of the SATA drive connectors are shown in **Chapter 3**.

Step 2: Insert the cable connector. Insert the cable connector into the on-board SATA drive connector until it clips into place. See **Figure 4-10**.

IMBA-Q370 ATX Motherboard

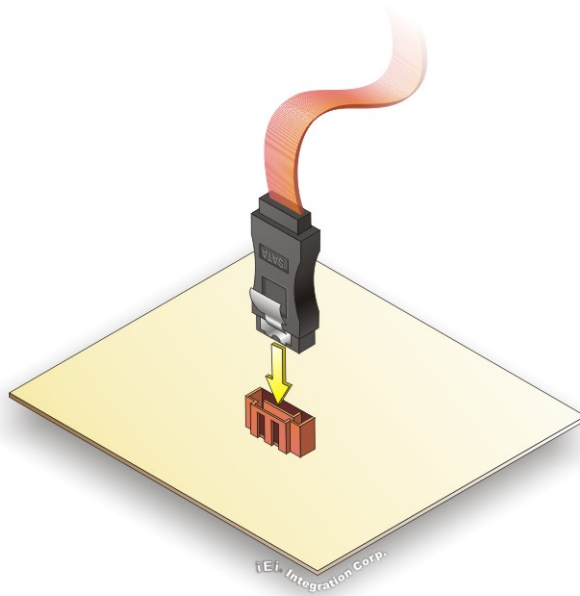

Figure 4-10: SATA Drive Cable Connection

- Step 3:** Connect the cable to the SATA disk. Connect the connector on the other end of the cable to the connector at the back of the SATA drive. See **Figure 4-11**.
- Step 4:** Connect the SATA power cable. Connect the SATA power connector to the back of the SATA drive. See **Figure 4-11**.

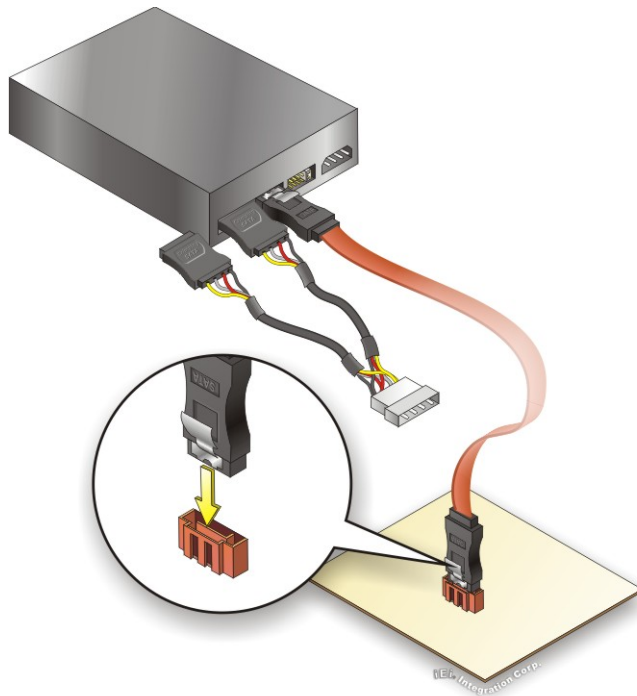

Figure 4-11: SATA Power Drive Connection

The SATA power cable can be bought from IEI. See Optional Items in Section 2.4.

IMBA-Q370 ATX Motherboard

4.8 Software Installation

All the drivers for the IMBA-Q370 are available on IEI Resource Download Center (<https://download.ieiworld.com>). Type IMBA-Q370 and press Enter to find all the relevant software, utilities, and documentation.

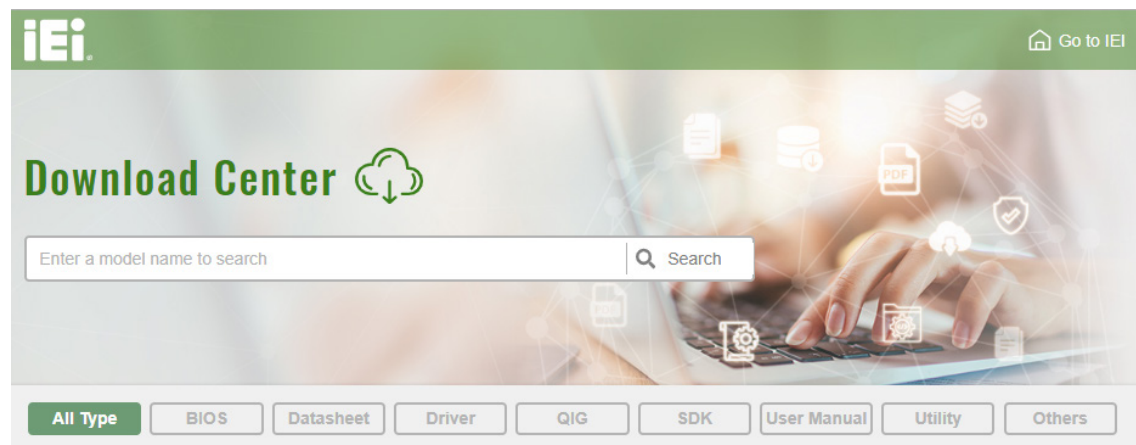
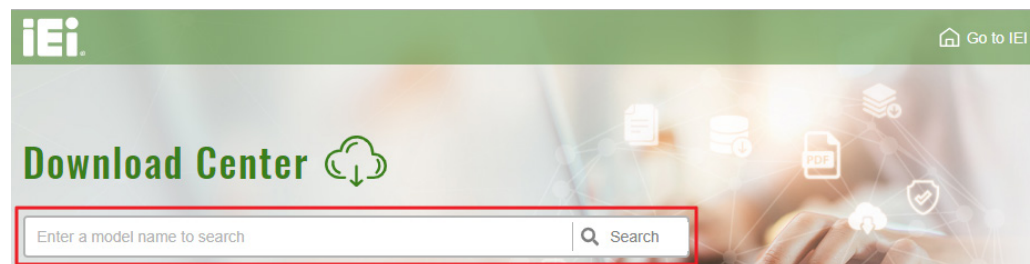

Figure 4-12: IEI Resource Download Center

4.9 Driver Download

To download drivers from IEI Resource Download Center, follow the steps below.

Step 1: Go to <https://download.ieiworld.com>. Type IMBA-Q370 and press Enter.



Step 2: All product-related software, utilities, and documentation will be listed. You can choose **Driver** to filter the result.

[All Type](#)
[BIOS](#)
[Datasheet](#)
[Driver](#)
[QIG](#)
[SDK](#)
[User Manual](#)
[Utility](#)
[Others](#)

WAFER-BT-i1 [Product Info](#)

[Embedded Computer](#) ▶ [Single Board Computer](#) ▶ [Embedded Board](#)
 3.5" SBC with Intel® 22nm Atom™/Celeron® on-board SoC

Driver

File Name	Published	Version	File Checksum
7B000-001033-RS V2.3.iso (2.23 GB)	2017/10/03	2.30	3B2DB1F792779A93A8F50DDDBC3943E30

Step 3: Click the driver file name on the page and you will be prompted with the following window. You can download the entire ISO file (❶), or click the small arrow to find an individual driver and click the file name to download (❷).

7B000-001168-RS_V1.4.iso

❶ [Click here to download entire ISO file. \(2.99 GB\)](#)

* Download individual file *

- Docs
 - 1.Chipset
 - ❷ 10.1.1.12.zip (2.7 MB)
 - 2.VGA
 - 3.Audio
 - 4.Lan
 - 5.USB 3.0
 - 6.Serial IO
 - 7.TXE
 - 8.Manual



NOTE:

To install software from the downloaded ISO image file in Windows 8, 8.1 or 10, double-click the ISO file to mount it as a virtual drive to view its content. On Windows 7 system, an additional tool (such as Virtual CD-ROM Control Panel from Microsoft) is needed to mount the file.

IMBA-Q370 ATX Motherboard

4.10 Intel® AMT Setup Procedure

The IMBA-Q370 is featured with the Intel® Active Management Technology (AMT). To enable the Intel® AMT function, follow the steps below.

- Step 1:** Make sure at least one of the memory sockets is installed with a DDR4 DIMM.
- Step 2:** Connect an Ethernet cable to the RJ-45 connector labeled **LAN1_USB1**.
- Step 3:** The AMI BIOS options regarding the Intel® ME or Intel® AMT must be enabled,
- Step 4:** Properly install the Intel® Management Engine Components drivers from the iAMT Driver & Utility directory in the driver CD.
- Step 5:** Configure the Intel® Management Engine BIOS extension (MEBx). To get into the Intel® MEBx settings, press <Ctrl+P> after a single beep during boot-up process. Enter the Intel® current ME password as it requires (the Intel® default password is **admin**).



NOTE:

To change the password, enter a new password following the strong password rule (containing at least one upper case letter, one lower case letter, one digit and one special character, and be at least eight characters).

Chapter

5

BIOS

IMBA-Q370 ATX Motherboard

5.1 Introduction

The BIOS is programmed onto the BIOS chip. The BIOS setup program allows changes to certain system settings. This chapter outlines the options that can be changed.



NOTE:

Some of the BIOS options may vary throughout the life cycle of the product and are subject to change without prior notice.

5.1.1 Starting Setup

The UEFI BIOS is activated when the computer is turned on. The setup program can be activated in one of two ways.

1. Press the **DEL** or **F2** key as soon as the system is turned on or
2. Press the **DEL** or **F2** key when the “**Press DEL or F2 to enter SETUP**” message appears on the screen.

If the message disappears before the **DEL** or **F2** key is pressed, restart the computer and try again.

5.1.2 Using Setup

Use the arrow keys to highlight items, press **ENTER** to select, use the PageUp and PageDown keys to change entries, press **F1** for help and press **ESC** to quit. Navigation keys are shown in **Table 5-1**.

Key	Function
Up arrow	Move to previous item
Down arrow	Move to next item
Left arrow	Move to the item on the left hand side
Right arrow	Move to the item on the right hand side
+	Increase the numeric value or make changes

Key	Function
-	Decrease the numeric value or make changes
Page Up	Move to the previous page
Page Dn	Move to the next page
Esc	Main Menu – Quit and not save changes into CMOS Status Page Setup Menu and Option Page Setup Menu -- Exit current page and return to Main Menu
F1	General help, only for Status Page Setup Menu and Option Page Setup Menu
F2	Load previous values
F3	Load optimized defaults
F4	Save changes and Exit BIOS

Table 5-1: BIOS Navigation Keys

5.1.3 Getting Help

When **F1** is pressed a small help window describing the appropriate keys to use and the possible selections for the highlighted item appears. To exit the Help Window, press the **Esc** key.

5.1.4 Unable to Reboot after Configuration Changes

If the computer cannot boot after changes to the system configuration is made, CMOS defaults. Use the clear CMOS button described in Chapter 4.

IMBA-Q370 ATX Motherboard

5.1.5 BIOS Menu Bar

The **menu bar** on top of the BIOS screen has the following main items:

- Main – Changes the basic system configuration.
- Advanced – Changes the advanced system settings.
- Chipset – Changes the chipset settings.
- Security – Sets User and Supervisor Passwords.
- Boot – Changes the system boot configuration.
- Save & Exit – Selects exit options and loads default settings
- Server Mgmt – Configures system event log and BMC network parameters

The following sections completely describe the configuration options found in the menu items at the top of the BIOS screen and listed above.

5.2 Main

The **Main** BIOS menu (**BIOS Menu 1**) appears when the **BIOS Setup** program is entered.

The **Main** menu gives an overview of the basic system information.

```

Aptio Setup Utility - Copyright (C) 2018 American Megatrends, Inc.
Main  Advanced  Chipset  Security  Boot  Save & Exit

BIOS Information
BIOS Vendor          American Megatrends
Core Version         5.13
Compliance          UEFI 2.6; PI 1.4
Project Version      B484AT14.BIN
Build Date and Time  03/28/2018 19:40:12

iWDD Vendor          iEi
iWDD Version         B484ET08.bin

IPMI Module          N/A

Processor Information
Name                 CoffeeLake DT
Brand String         Intel(R) Core(TM) CPU
                    i3-8100T CPU @ 3.10GHz
Speed                3100 MHz
ID                   0X906E8
Stepping             B0
Number of Processors 4Core(s) / 4Thread(s)
Microcode Revision   84
GT Info              GT2 (0x3E91)

IGFX VBIOS Version   1008
Memory RC Version    0.7.1.58
Total Memory         8192 MB
Memory Frequency     2133 MHz

PCH Information
Name                 CNL PCH-H
PCH SKU              Q370
Stepping             B0

ME FW Version        12.0.0.1068
ME Firmware SKU      Corporate SKU

Access Level          Administrator

System Date          [Thu 01/28/2018]
System Time          [15:10:27]

Set the Date. Use Tab to
switch between Date
elements.

-----
-><: Select Screen
^v: Select Item
Enter: Select
+/-: Change Opt.
F1: General Help
F2: Previous Values
F3: Optimized Defaults
F4: Save & Exit
ESC: Exit

Version 2.20.1271. Copyright (C) 2018 American Megatrends, Inc.
    
```

BIOS Menu 1: Main

The **Main** menu has two user configurable fields:

➔ **System Date [xx/xx/xx]**

Use the **System Date** option to set the system date. Manually enter the day, month and year.

IMBA-Q370 ATX Motherboard

→ System Time [xx:xx:xx]

Use the **System Time** option to set the system time. Manually enter the hours, minutes and seconds.

5.3 Advanced

Use the **Advanced** menu (**BIOS Menu 2**) to configure the CPU and peripheral devices through the following sub-menus:



WARNING!

Setting the wrong values in the sections below may cause the system to malfunction. Make sure that the settings made are compatible with the hardware.

```

Aptio Setup Utility - Copyright (C) 2018 American Megatrends, Inc.
Main   Advanced  Chipset  Security  Boot    Save & Exit

> CPU Configuration          CPU Configuration
> PCH-FW Configuration      Parameters
> Trusted Computing
> ACPI Settings
> iWDD H/M Monitor
> F81866 Super IO Configuration
> RTC Wake Settings
> Serial Port Console Redirection
> USB Configuration
> NVMe Configuration
> iEi Feature

-----
→←: Select Screen
↑↓: Select Item
Enter: Select
+/-: Change Opt.
F1: General Help
F2: Previous Values
F3: Optimized Defaults
F4: Save & Exit
ESC: Exit

Version 2.20.1271. Copyright (C) 2018 American Megatrends, Inc.
    
```

BIOS Menu 2: Advanced

5.3.1 CPU Configuration

Use the **CPU Configuration** menu (**BIOS Menu 3**) to view detailed CPU specifications or enable the Intel Virtualization Technology.

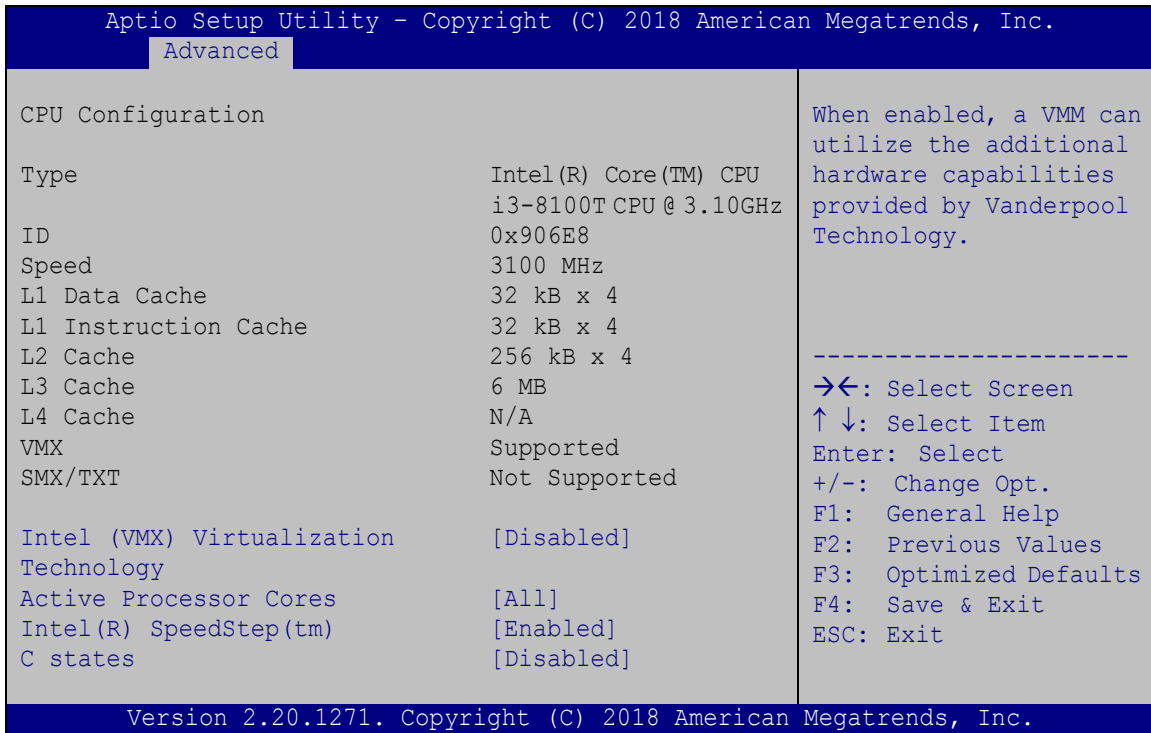

BIOS Menu 3: CPU Configuration

→ Intel (VMX) Virtualization Technology [Disabled]

Use the **Intel (VMX) Virtualization Technology** option to enable or disable virtualization on the system. When combined with third party software, Intel® Virtualization technology allows several OSs to run on the same system at the same time.

- **Disabled** **DEFAULT** Disables Intel Virtualization Technology.
- **Enabled** Enables Intel Virtualization Technology.

IMBA-Q370 ATX Motherboard

→ Active Processor Cores [All]

Use the **Active Processor Cores** BIOS option to enable numbers of cores in the processor package.

- **All** **DEFAULT** Enable all cores in the processor package.
- **1** Enable one core in the processor package.
- **2** Enable two cores in the processor package.
- **3** Enable three cores in the processor package.

→ Intel(R) SpeedStep(tm) [Enabled]

Use the **Intel(R) SpeedStep(tm)** option to enable or disable the Intel® SpeedStep Technology which allows more than two frequency ranges to be supported.

- **Disabled** Disables Intel® SpeedStep Technology
- **Enabled** **DEFAULT** Enables Intel® SpeedStep Technology

→ C states [Disabled]

Use the **C states** option to enable or disable CPU power management which allows CPU to go to C states when it is not 100% utilized.

- **Disabled** **DEFAULT** Disables CPU power management
- **Enabled** Enables CPU power management

5.3.2 PCH-FW Configuration

The **PCH-FW Configuration** menu (**BIOS Menu 4**) allows Intel® Active Management Technology (AMT) options to be configured.

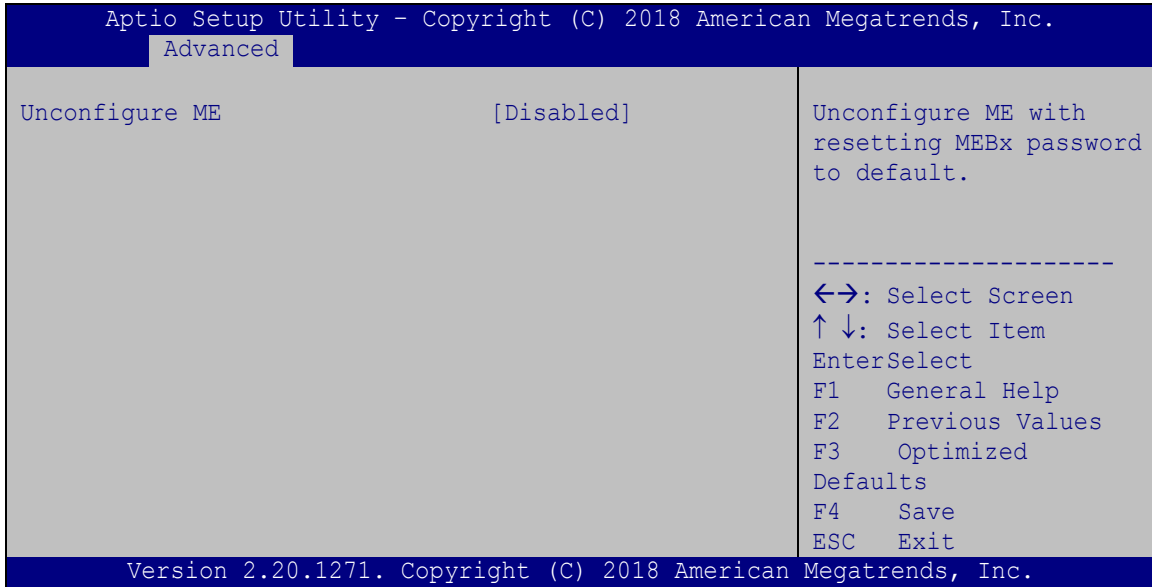

BIOS Menu 4: PCH-FW Configuration

→ **Unconfigure ME [Disabled]**

Use the **Unconfigure ME** option to unconfigure ME with resetting MEBx password to default.

- **Disabled** **DEFAULT** Not unconfigure ME with resetting MEBx password to default
- **Enabled** Unconfigure ME with resetting MEBx password to default

IMBA-Q370 ATX Motherboard

5.3.3 Trusted Computing

Use the **Trusted Computing** menu (**BIOS Menu 5**) to configure settings related to the Trusted Computing Group (TCG) Trusted Platform Module (TPM).

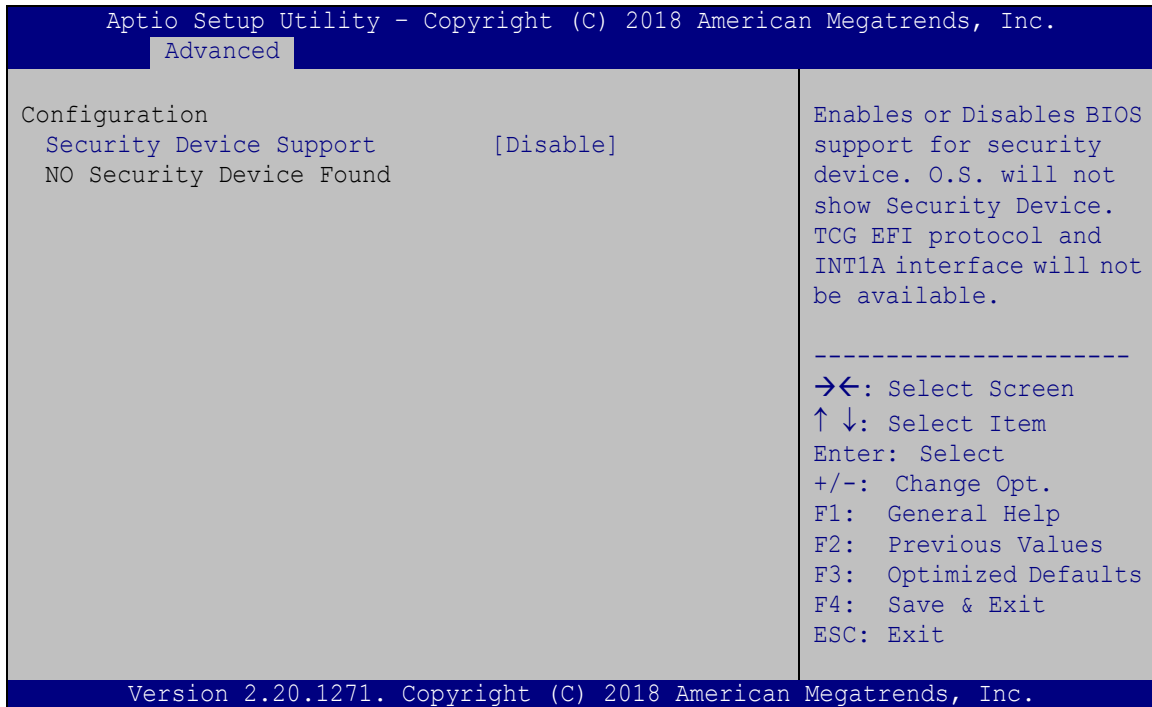

BIOS Menu 5: Trusted Computing

→ Security Device Support [Disable]

Use the **Security Device Support** option to configure support for the TPM.

- **Disable** **DEFAULT** TPM support is disabled.
- **Enable** TPM support is enabled.

5.3.4 ACPI Settings

The **ACPI Settings** menu (**BIOS Menu 6**) configures the Advanced Configuration and Power Interface (ACPI) options.

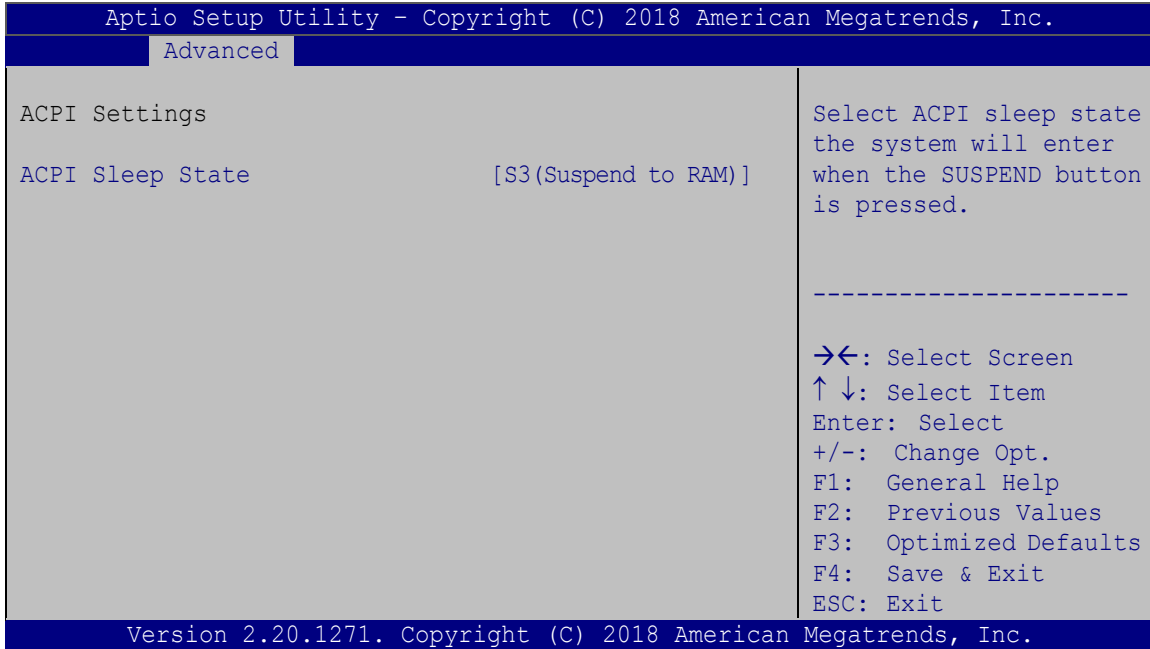

BIOS Menu 6: ACPI Configuration

→ ACPI Sleep State [S3 (Suspend to RAM)]

Use the **ACPI Sleep State** option to specify the sleep state the system enters when it is not being used.

- S3 (Suspend to RAM) DEFAULT** The caches are flushed and the CPU is powered off. Power to the RAM is maintained. The computer returns slower to a working state, but more power is saved.

IMBA-Q370 ATX Motherboard

5.3.5 iWDD H/W Monitor

The **iWDD H/W Monitor** menu (**BIOS Menu 7**) contains the fan configuration submenu, and displays the system temperature and CPU fan speed.

```

Aptio Setup Utility - Copyright (C) 2018 American Megatrends, Inc.
Advanced
PC Health Status
CPU temperature           :+42 °C
System temperature       :+30 °C
CPU_FAN1 Speed           :2151 RPM
SYS_FAN1 Speed           :N/A
CPU_CORE                  :+0.929 V
+5V                       :+5.038 V
+12V                      :+12.064 V
+DDR                      :+1.196 V
+5VSB                     :+5.085 V
+3.3V                     :+3.328 V
+3.3VSB                   :+3.294 V
> Smart Fan Mode Configuration

Smart Fan Mode Select
-----
-><: Select Screen
↑↓: Select Item
Enter: Select
+/-: Change Opt.
F1: General Help
F2: Previous Values
F3: Optimized Defaults
F4: Save & Exit
ESC: Exit

Version 2.20.1271. Copyright (C) 2018 American Megatrends, Inc.

```

BIOS Menu 7: iWDD H/W Monitor

→ PC Health Status

The following system parameters and values are shown. The system parameters that are monitored are:

- System Temperatures:
 - CPU Temperature
 - System Temperature
- Fan Speeds:
 - CPU Fan Speed
 - System Fan Speed
- Voltages:
 - CPU_CORE
 - +5V

- +12V
- DDR
- +5VSB
- +3.3V
- +3.3VSB

5.3.5.1 Smart Fan Mode Configuration

Use the **Smart Fan Mode Configuration** submenu (**BIOS Menu 8**) to configure the CPU/system fan temperature and speed settings.

```

Aptio Setup Utility - Copyright (C) 2018 American Megatrends, Inc.
-----
Advanced
-----
Smart Fan Mode Configuration
CPU_FAN1 Smart Fan Control      [Auto Mode]
Auto mode fan start temperature 50
Auto mode fan off temperature  40
Auto mode fan start PWM        30
Auto mode fan slope PWM        2

SYS_FAN1 Smart Fan Control      [Auto Mode]
Auto mode fan start temperature 50
Auto mode fan off temperature  40
Auto mode fan start PWM        30
Auto mode fan slope PWM        1

Smart Fan Mode Select
-----
-><: Select Screen
↑↓: Select Item
Enter: Select
+/-: Change Opt.
F1: General Help
F2: Previous Values
F3: Optimized Defaults
F4: Save & Exit
ESC: Exit

Version 2.20.1271. Copyright (C) 2018 American Megatrends, Inc.
    
```

BIOS Menu 8: Smart Fan Mode Configuration

→ CPU_FAN1 Smart Fan Control/SYS_FAN1 Smart Fan Control [Auto Mode]

Use the **CPU_FAN1 Smart Fan Control/SYS_FAN1 Smart Fan Control** option to configure the CPU/System Smart Fan.

- **Manual Mode** The fan spins at the speed set in Manual Mode settings.
- **Auto Mode** **DEFAULT** The fan adjusts its speed using Auto Mode settings.

IMBA-Q370 ATX Motherboard

→ Auto mode fan start/off temperature

Use the + or – key to change the **Auto mode fan start/off temperature** value. Enter a decimal number between 1 and 100.

→ Auto mode fan start PWM

Use the + or – key to change the **Auto mode fan start PWM** value. Enter a decimal number between 1 and 100.

→ Auto mode fan slope PWM

Use the + or – key to change the **Auto mode fan slope PWM** value. Enter a decimal number between 1 and 8.

5.3.6 F81866 Super IO Configuration

Use the **F81866 Super IO Configuration** menu (**BIOS Menu 9**) to set or change the configurations for the parallel ports and serial ports.

```

Aptio Setup Utility - Copyright (C) 2018 American Megatrends, Inc.
  Advanced
Super IO Configuration
Super IO Chip                F81866
> Serial Port 1 Configuration
> Serial Port 2 Configuration
> Serial Port 3 Configuration
> Serial Port 4 Configuration
> Serial Port 5 Configuration
> Serial Port 6 Configuration
> Parallel Port Configuration

Case Open Detection          [Disabled]

Set Parameters of Serial
Port 1 (COMA)
-----
→←: Select Screen
↑↓: Select Item
Enter: Select
+/-: Change Opt.
F1: General Help
F2: Previous Values
F3: Optimized Defaults
F4: Save & Exit
ESC: Exit

Version 2.20.1271. Copyright (C) 2018 American Megatrends, Inc.
  
```

BIOS Menu 9: F81866 Super IO Configuration

→ Case Open Beep [Disabled]

Use the **Case Open Beep** option to enable or disable the case open beep function.

→ **Disabled** **DEFAULT** Disable the case open beep function

- ➔ **Enabled** Enable the case open beep function

5.3.6.1 Serial Port n Configuration

Use the **Serial Port n Configuration** menu (**BIOS Menu 10**) to configure the serial port n.

```

Aptio Setup Utility - Copyright (C) 2018 American Megatrends, Inc.
  Advanced
Serial Port n Configuration
Serial Port          [Enabled]
Device Settings     IO=3F8h; IRQ=4
Change Settings     [Auto]
-----
➔←: Select Screen
↑↓: Select Item
Enter: Select
+/-: Change Opt.
F1: General Help
F2: Previous Values
F3: Optimized Defaults
F4: Save & Exit
ESC: Exit
Version 2.20.1271. Copyright (C) 2018 American Megatrends, Inc.
  
```

BIOS Menu 10: Serial Port n Configuration Menu

5.3.6.2 Serial Port 1 Configuration

- ➔ **Serial Port [Enabled]**

Use the **Serial Port** option to enable or disable the serial port.

- ➔ **Disabled** Disable the serial port
- ➔ **Enabled** **DEFAULT** Enable the serial port

- ➔ **Change Settings [Auto]**

Use the **Change Settings** option to change the serial port IO port address and interrupt address.

- ➔ **Auto** **DEFAULT** The serial port IO port address and interrupt address are automatically detected.

IMBA-Q370 ATX Motherboard

- **IO=3F8h;**
IRQ=4 Serial Port I/O port address is 3F8h and the interrupt address is IRQ4
- **IO=3F8h;**
IRQ=3, 4, 5, 6,
7, 9, 10, 11, 12 Serial Port I/O port address is 3F8h and the interrupt address is IRQ3, 4, 5, 6, 7, 9, 10, 11, 12
- **IO=2F8h;**
IRQ=3, 4, 5, 6,
7, 9, 10, 11, 12 Serial Port I/O port address is 2F8h and the interrupt address is IRQ3, 4, 5, 6, 7, 9, 10, 11, 12
- **IO=3E8h;**
IRQ=3, 4, 5, 6,
7, 9, 10, 11, 12 Serial Port I/O port address is 3E8h and the interrupt address is IRQ3, 4, 5, 6, 7, 9, 10, 11, 12
- **IO=2E8h;**
IRQ=3, 4, 5, 6,
7, 9, 10, 11, 12 Serial Port I/O port address is 2E8h and the interrupt address is IRQ3, 4, 5, 6, 7, 9, 10, 11, 12

5.3.6.3 Serial Port 2 Configuration

→ Serial Port [Enabled]

Use the **Serial Port** option to enable or disable the serial port.

- **Disabled** Disable the serial port
- **Enabled DEFAULT** Enable the serial port

→ Change Settings [Auto]

Use the **Change Settings** option to change the serial port IO port address and interrupt address.

- **Auto DEFAULT** The serial port IO port address and interrupt address are automatically detected.
- **IO=2F8h;**
IRQ=3 Serial Port I/O port address is 2F8h and the interrupt address is IRQ3

- **IO=3F8h;**
IRQ=3, 4, 5, 6,
7, 9, 10, 11, 12 Serial Port I/O port address is 3F8h and the interrupt address is IRQ3, 4, 5, 6, 7, 9, 10, 11, 12
- **IO=2F8h;**
IRQ=3, 4, 5, 6,
7, 9, 10, 11, 12 Serial Port I/O port address is 2F8h and the interrupt address is IRQ3, 4, 5, 6, 7, 9, 10, 11, 12
- **IO=3E8h;**
IRQ=3, 4, 5, 6,
7, 9, 10, 11, 12 Serial Port I/O port address is 3E8h and the interrupt address is IRQ3, 4, 5, 6, 7, 9, 10, 11, 12
- **IO=2E8h;**
IRQ=3, 4, 5, 6,
7, 9, 10, 11, 12 Serial Port I/O port address is 2E8h and the interrupt address is IRQ3, 4, 5, 6, 7, 9, 10, 11, 12

5.3.6.4 Serial Port 3 Configuration

→ Serial Port [Enabled]

Use the **Serial Port** option to enable or disable the serial port.

- **Disabled** Disable the serial port
- **Enabled** **DEFAULT** Enable the serial port

→ Change Settings [Auto]

Use the **Change Settings** option to change the serial port IO port address and interrupt address.

- **Auto** **DEFAULT** The serial port IO port address and interrupt address are automatically detected.
- **IO=3E8h;**
IRQ=7 Serial Port I/O port address is 3E8h and the interrupt address is IRQ7
- **IO=3F8h;**
IRQ=3, 4, 5, 6,
7, 9, 10, 11, 12 Serial Port I/O port address is 3F8h and the interrupt address is IRQ3, 4, 5, 6, 7, 9, 10, 11, 12

IMBA-Q370 ATX Motherboard

- ➔ **IO=2F8h;**
IRQ=3, 4, 5, 6,
7, 9, 10, 11, 12

Serial Port I/O port address is 2F8h and the interrupt address is IRQ3, 4, 5, 6, 7, 9, 10, 11, 12
- ➔ **IO=3E8h;**
IRQ=3, 4, 5, 6,
7, 9, 10, 11, 12

Serial Port I/O port address is 3E8h and the interrupt address is IRQ3, 4, 5, 6, 7, 9, 10, 11, 12
- ➔ **IO=2E8h;**
IRQ=3, 4, 5, 6,
7, 9, 10, 11, 12

Serial Port I/O port address is 2E8h and the interrupt address is IRQ3, 4, 5, 6, 7, 9, 10, 11, 12
- ➔ **IO=220h;**
IRQ=3, 4, 5, 6,
7, 9, 10, 11, 12

Serial Port I/O port address is 220h and the interrupt address is IRQ3, 4, 5, 6, 7, 9, 10, 11, 12
- ➔ **IO=228h;**
IRQ=3, 4, 5, 6,
7, 9, 10, 11, 12

Serial Port I/O port address is 228h and the interrupt address is IRQ3, 4, 5, 6, 7, 9, 10, 11, 12

5.3.6.5 Serial Port 4 Configuration

➔ Serial Port [Enabled]

Use the **Serial Port** option to enable or disable the serial port.

- ➔ **Disabled** Disable the serial port
- ➔ **Enabled** **DEFAULT** Enable the serial port

➔ Change Settings [Auto]

Use the **Change Settings** option to change the serial port IO port address and interrupt address.

- ➔ **Auto** **DEFAULT** The serial port IO port address and interrupt address are automatically detected.

- **IO=2E8h;**
IRQ=7 Serial Port I/O port address is 2E8h and the interrupt address is IRQ7
- **IO=3F8h;**
IRQ=3, 4, 5, 6,
7, 9, 10, 11, 12 Serial Port I/O port address is 3F8h and the interrupt address is IRQ3, 4, 5, 6, 7, 9, 10, 11, 12
- **IO=2F8h;**
IRQ=3, 4, 5, 6,
7, 9, 10, 11, 12 Serial Port I/O port address is 2F8h and the interrupt address is IRQ3, 4, 5, 6, 7, 9, 10, 11, 12
- **IO=3E8h;**
IRQ=3, 4, 5, 6,
7, 9, 10, 11, 12 Serial Port I/O port address is 3E8h and the interrupt address is IRQ3, 4, 5, 6, 7, 9, 10, 11, 12
- **IO=2E8h;**
IRQ=3, 4, 5, 6,
7, 9, 10, 11, 12 Serial Port I/O port address is 2E8h and the interrupt address is IRQ3, 4, 5, 6, 7, 9, 10, 11, 12
- **IO=220h;**
IRQ=3, 4, 5, 6,
7, 9, 10, 11, 12 Serial Port I/O port address is 220h and the interrupt address is IRQ3, 4, 5, 6, 7, 9, 10, 11, 12
- **IO=228h;**
IRQ=3, 4, 5, 6,
7, 9, 10, 11, 12 Serial Port I/O port address is 228h and the interrupt address is IRQ3, 4, 5, 6, 7, 9, 10, 11, 12

5.3.6.6 Serial Port 5 Configuration

→ Serial Port [Enabled]

Use the **Serial Port** option to enable or disable the serial port.

- **Disabled** Disable the serial port
- **Enabled DEFAULT** Enable the serial port

→ Change Settings [Auto]

Use the **Change Settings** option to change the serial port IO port address and interrupt address.

IMBA-Q370 ATX Motherboard

- | | | | |
|---|--|----------------|---|
| → | Auto | DEFAULT | The serial port IO port address and interrupt address are automatically detected. |
| → | IO=220h;
IRQ=10 | | Serial Port I/O port address is 220h and the interrupt address is IRQ10 |
| → | IO=3F8h;
IRQ=3, 4,
5, 6, 7, 9,
10, 11, 12 | | Serial Port I/O port address is 3F8h and the interrupt address is IRQ3, 4, 5, 6, 7, 9, 10, 11, 12 |
| → | IO=2F8h;
IRQ=3, 4,
5, 6, 7, 9,
10, 11, 12 | | Serial Port I/O port address is 2F8h and the interrupt address is IRQ3, 4, 5, 6, 7, 9, 10, 11, 12 |
| → | IO=3E8h;
IRQ=3, 4,
5, 6, 7, 9,
10, 11, 12 | | Serial Port I/O port address is 3E8h and the interrupt address is IRQ3, 4, 5, 6, 7, 9, 10, 11, 12 |
| → | IO=2E8h;
IRQ=3, 4,
5, 6, 7, 9,
10, 11, 12 | | Serial Port I/O port address is 2E8h and the interrupt address is IRQ3, 4, 5, 6, 7, 9, 10, 11, 12 |
| → | IO=220h;
IRQ=3, 4,
5, 6, 7, 9,
10, 11, 12 | | Serial Port I/O port address is 220h and the interrupt address is IRQ3, 4, 5, 6, 7, 9, 10, 11, 12 |
| → | IO=228h;
IRQ=3, 4,
5, 6, 7, 9,
10, 11, 12 | | Serial Port I/O port address is 228h and the interrupt address is IRQ3, 4, 5, 6, 7, 9, 10, 11, 12 |

→ Transfer Mode [RS232]

Use the **Transfer Mode** option to select the Serial Port 5 signaling mode.

- **RS422** Serial Port 5 signaling mode is RS-422
- **RS485** Serial Port 5 signaling mode is RS-485
- **RS232** **DEFAULT** Serial Port 5 signaling mode is RS-232

5.3.6.7 Serial Port 6 Configuration

→ Serial Port [Enabled]

Use the **Serial Port** option to enable or disable the serial port.

- **Disabled** Disable the serial port
- **Enabled** **DEFAULT** Enable the serial port

→ Change Settings [Auto]

Use the **Change Settings** option to change the serial port IO port address and interrupt address.

- **Auto** **DEFAULT** The serial port IO port address and interrupt address are automatically detected.
- **IO=228h;**
IRQ=10 Serial Port I/O port address is 228h and the interrupt address is IRQ10
- **IO=3F8h;**
IRQ=3, 4,
5, 6, 7, 9,
10, 11, 12 Serial Port I/O port address is 3F8h and the interrupt address is IRQ3, 4, 5, 6, 7, 9, 10, 11, 12
- **IO=2F8h;**
IRQ=3, 4,
5, 6, 7, 9,
10, 11, 12 Serial Port I/O port address is 2F8h and the interrupt address is IRQ3, 4, 5, 6, 7, 9, 10, 11, 12

IMBA-Q370 ATX Motherboard

- **IO=3E8h;**
IRQ=3, 4,
5, 6, 7, 9,
10, 11, 12 Serial Port I/O port address is 3E8h and the interrupt address is IRQ3, 4, 5, 6, 7, 9, 10, 11, 12

- **IO=2E8h;**
IRQ=3, 4,
5, 6, 7, 9,
10, 11, 12 Serial Port I/O port address is 2E8h and the interrupt address is IRQ3, 4, 5, 6, 7, 9, 10, 11, 12

- **IO=220h;**
IRQ=3, 4,
5, 6, 7, 9,
10, 11, 12 Serial Port I/O port address is 220h and the interrupt address is IRQ3, 4, 5, 6, 7, 9, 10, 11, 12

- **IO=228h;**
IRQ=3, 4,
5, 6, 7, 9,
10, 11, 12 Serial Port I/O port address is 228h and the interrupt address is IRQ3, 4, 5, 6, 7, 9, 10, 11, 12

→ **Transfer Mode [RS232]**

Use the **Transfer Mode** option to select the Serial Port 6 signaling mode.

- **RS422** Serial Port 6 signaling mode is RS-422
- **RS485** Serial Port 6 signaling mode is RS-485
- **RS232** **DEFAULT** Serial Port 6 signaling mode is RS-232

5.3.6.8 Parallel Port Configuration

Use the **Parallel Port Configuration** menu (**BIOS Menu 11**) to configure the parallel port.

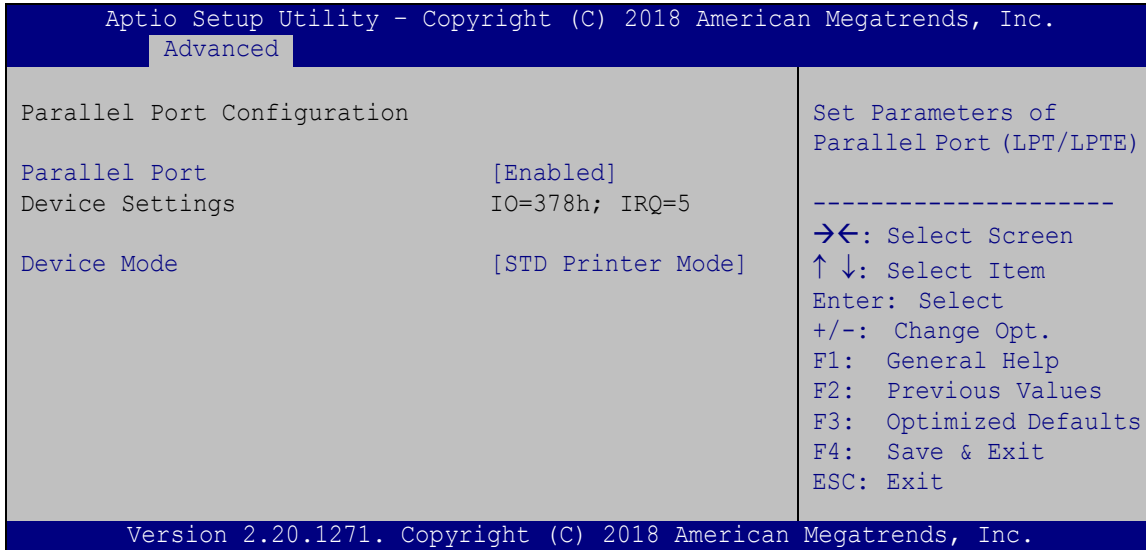

BIOS Menu 11: Parallel Port Configuration Menu

→ Parallel Port [Enabled]

Use the **Parallel Port** option to enable or disable the parallel port.

- **Disabled** Disable the parallel port
- **Enabled** **DEFAULT** Enable the parallel port

→ Device Mode [STD Printer Mode]

Use the **Device Mode** option to select the mode the parallel port operates in.

Configuration options are listed below.

- STD Printer Mode **Default**
- SPP Mode
- EPP-1.9 and SPP Mode
- EPP-1.7 and SPP Mode
- ECP Mode
- ECP and EPP 1.9 Mode
- ECP and EPP 1.7 Mode

IMBA-Q370 ATX Motherboard

5.3.7 RTC Wake Settings

The **RTC Wake Settings** menu (**BIOS Menu 12**) enables the system to wake at the specified time.

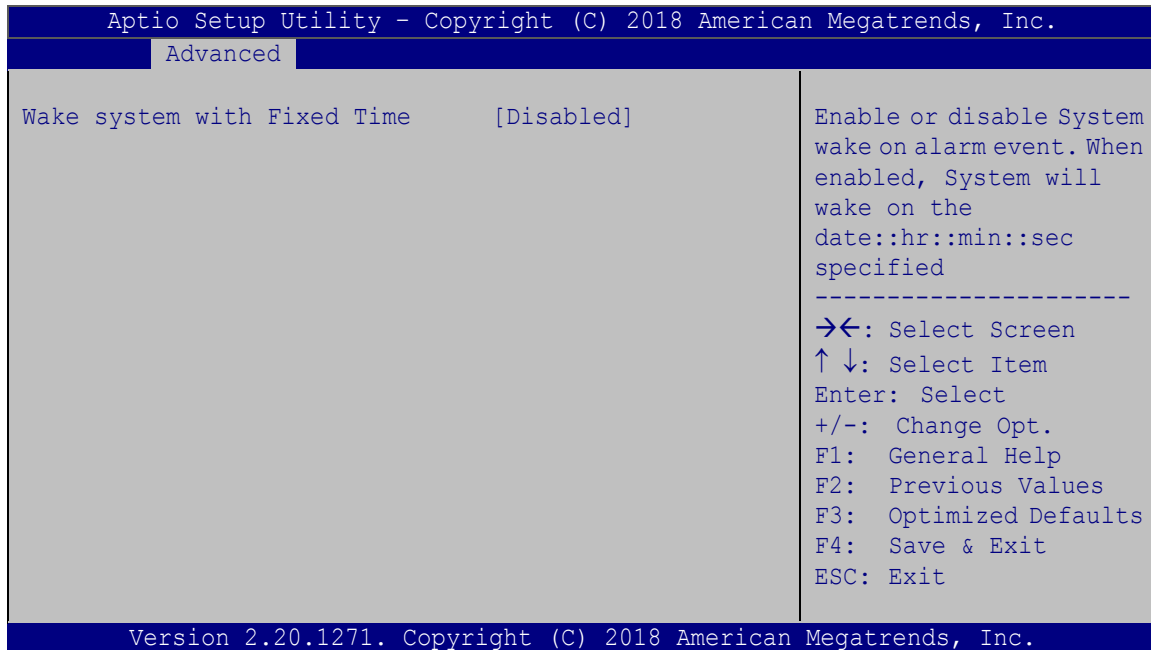

BIOS Menu 12: RTC Wake Settings

→ Wake system with Fixed Time [Disabled]

Use the **Wake system with Fixed Time** option to enable or disable the system wake on alarm event.

- **Disabled** **DEFAULT** The real time clock (RTC) cannot generate a wake event
- **Enabled** If selected, the **Wake up every day** option appears allowing you to enable to disable the system to wake every day at the specified time. Besides, the following options appear with values that can be selected:

Wake up date

Wake up hour

Wake up minute

Wake up second

After setting the alarm, the computer turns itself on from a suspend state when the alarm goes off.

5.3.8 Serial Port Console Redirection

The **Serial Port Console Redirection** menu (**BIOS Menu 13**) allows the console redirection options to be configured. Console redirection allows users to maintain a system remotely by re-directing keyboard input and text output through the serial port.

```

Aptio Setup Utility - Copyright (C) 2018 American Megatrends, Inc.
  Advanced
COM1
  Console Redirection [Disabled]
  Console Redirection Settings
COM2
  Console Redirection [Disabled]
  Console Redirection Settings
COM3
  Console Redirection [Disabled]
  Console Redirection Settings
COM4
  Console Redirection [Disabled]
  Console Redirection Settings
COM5
  Console Redirection [Disabled]
  Console Redirection Settings
COM6
  Console Redirection [Disabled]
  Console Redirection Settings
iAMT SOL
COM7 (Pci Bus0,Dev22,Func3)
  Console Redirection [Disabled]
  Console Redirection Settings
Legacy Console Redirection
  Legacy Console Redirection Settings

-----
-><: Select Screen
↑ ↓: Select Item
Enter: Select
+/-: Change Opt.
F1: General Help
F2: Previous Values
F3: Optimize Defaults
F4: Save & Exit
ESC: Exit

Version 2.20.1271. Copyright (C) 2018 American Megatrends, Inc.
  
```

BIOS Menu 13: Serial Port Console Redirection

IMBA-Q370 ATX Motherboard

→ Console Redirection [Disabled]

Use **Console Redirection** option to enable or disable the console redirection function.

- **Disabled** **DEFAULT** Disabled the console redirection function
- **Enabled** Enabled the console redirection function

The following options are available in the **Console Redirection Settings** submenu when the **Console Redirection** option is enabled.

→ Terminal Type [ANSI]

Use the **Terminal Type** option to specify the remote terminal type.

- **VT100** The target terminal type is VT100
- **VT100+** The target terminal type is VT100+
- **VT-UTF8** The target terminal type is VT-UTF8
- **ANSI** **DEFAULT** The target terminal type is ANSI

→ Bits per second [115200]

Use the **Bits per second** option to specify the serial port transmission speed. The speed must match the other side. Long or noisy lines may require lower speeds.

- **9600** Sets the serial port transmission speed at 9600.
- **19200** Sets the serial port transmission speed at 19200.
- **57600** Sets the serial port transmission speed at 57600.
- **115200** **DEFAULT** Sets the serial port transmission speed at 115200.

→ Data Bits [8]

Use the **Data Bits** option to specify the number of data bits.

- **7** Sets the data bits at 7.
- **8** **DEFAULT** Sets the data bits at 8.

→ Parity [None]

Use the **Parity** option to specify the parity bit that can be sent with the data bits for detecting the transmission errors.

- None** **DEFAULT** No parity bit is sent with the data bits.
- Even** The parity bit is 0 if the number of ones in the data bits is even.
- Odd** The parity bit is 0 if the number of ones in the data bits is odd.
- Mark** The parity bit is always 1. This option does not provide error detection.
- Space** The parity bit is always 0. This option does not provide error detection.

→ Stop Bits [1]

Use the **Stop Bits** option to specify the number of stop bits used to indicate the end of a serial data packet. Communication with slow devices may require more than 1 stop bit.

- 1** **DEFAULT** Sets the number of stop bits at 1.
- 2** Sets the number of stop bits at 2.

IMBA-Q370 ATX Motherboard

5.3.8.1 Legacy Console Redirection Settings

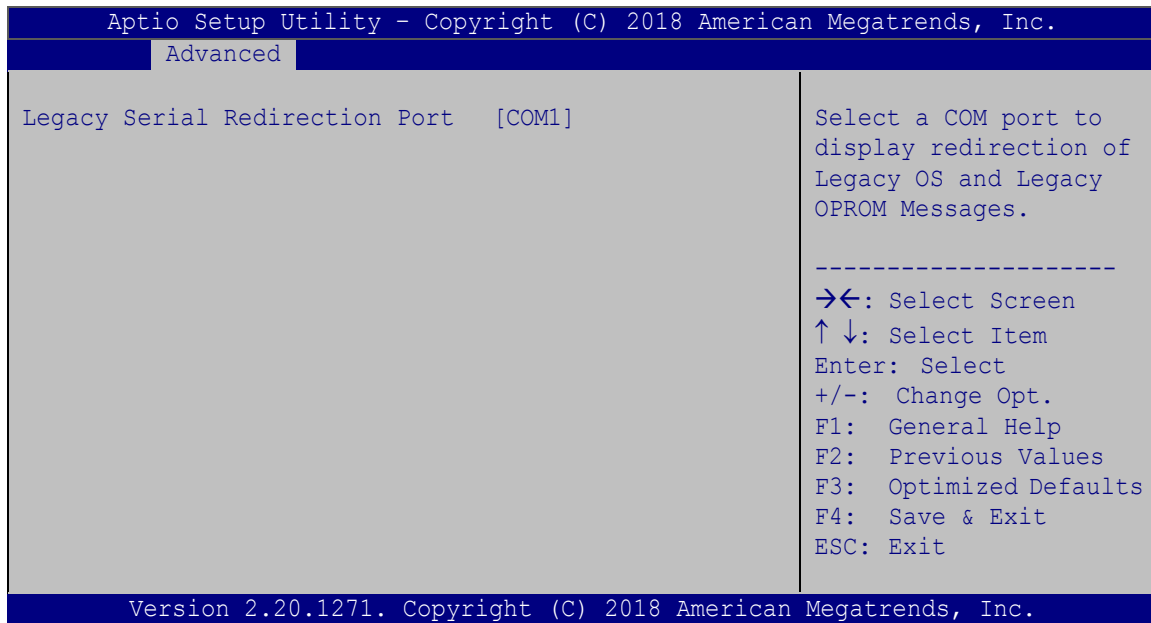

BIOS Menu 14: Legacy Console Redirection Settings

→ Legacy Serial Redirection Port [COM1]

Use the **Legacy Serial Redirection Port** option to select a COM port to display redirection of legacy OS and legacy OPRM messages. Configuration options are listed below.

- COM1 **Default**
- COM2
- COM3
- COM4
- COM5
- COM6
- COM7 (Pci Bus0,Dev22,Func3)

5.3.9 USB Configuration

Use the **USB Configuration** menu (**BIOS Menu 15**) to read USB configuration information and configure the USB settings.



BIOS Menu 15: USB Configuration

→ Legacy USB Support [Enabled]

Use the **Legacy USB Support** BIOS option to enable USB mouse and USB keyboard support. Normally if this option is not enabled, any attached USB mouse or USB keyboard does not become available until a USB compatible operating system is fully booted with all USB drivers loaded. When this option is enabled, any attached USB mouse or USB keyboard can control the system even when there is no USB driver loaded onto the system.

- **Enabled** **DEFAULT** Legacy USB support enabled
- **Disabled** Legacy USB support disabled
- **Auto** Legacy USB support disabled if no USB devices are connected

IMBA-Q370 ATX Motherboard

5.3.10 NVMe Configuration

Use the **NVMe Configuration (BIOS Menu 16)** menu to display the NVMe controller and device information.

```
Aptio Setup Utility - Copyright (C) 2018 American Megatrends, Inc.
Advanced
NVMe controller and Drive information
No NVMe Device Found
-----
-><: Select Screen
↑↓: Select Item
Enter: Select
+/-: Change Opt.
F1: General Help
F2: Previous Values
F3: Optimized Defaults
F4: Save & Exit
ESC: Exit
Version 2.20.1271. Copyright (C) 2018 American Megatrends, Inc.
```

BIOS Menu 16: NVMe Configuration

5.3.11 iEi Feature

Use the **iEi Feature** menu (**BIOS Menu 17**) to configure One Key Recovery function.

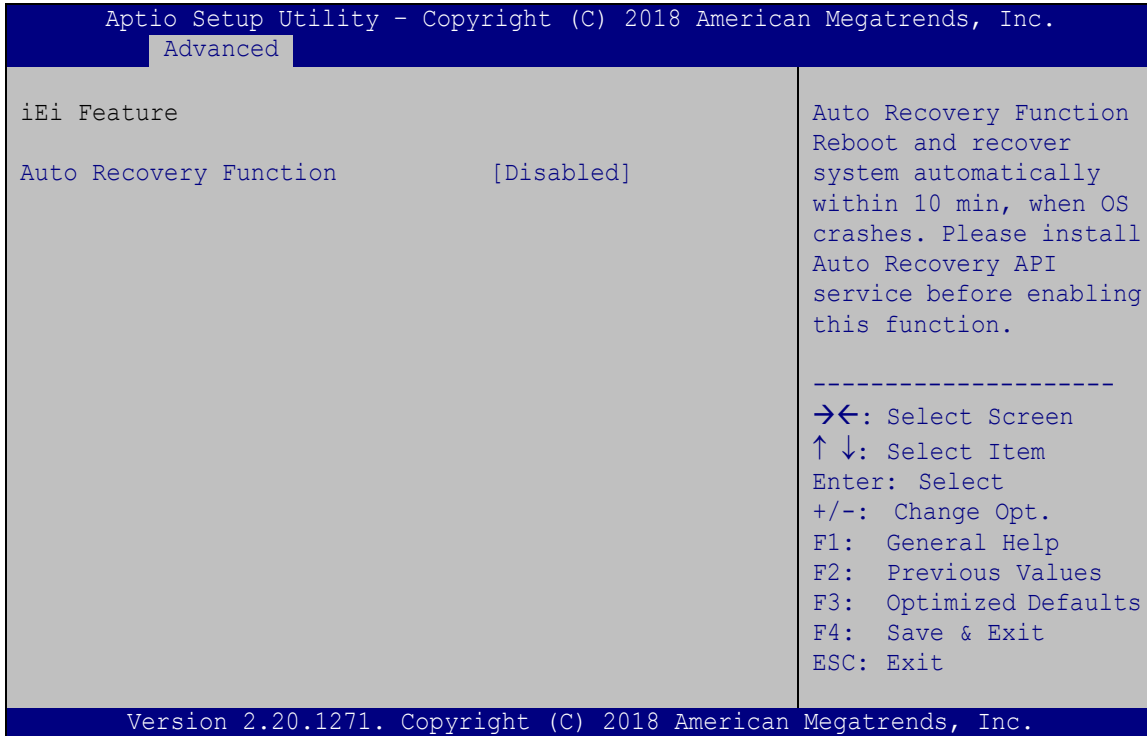

BIOS Menu 17: iEi Feature

➔ **Auto Recovery Function [Disabled]**

Use the **Auto Recovery Function** BIOS option to enable or disable the auto recovery function of the IEI One Key Recovery.

- ➔ **Disabled** **DEFAULT** Auto recovery function disabled
- ➔ **Enabled** Auto recovery function enabled

IMBA-Q370 ATX Motherboard

5.4 Chipset

Use the **Chipset** menu (**BIOS Menu 18**) to access the PCH IO and System Agent (SA) configuration menus.



WARNING!

Setting the wrong values for the Chipset BIOS selections in the Chipset BIOS menu may cause the system to malfunction.

```

Aptio Setup Utility - Copyright (C) 2018 American Megatrends, Inc.
Main   Advanced  Chipset  Security  Boot   Save & Exit
-----
> System Agent (SA) Configuration      System Agent (SA)
> PCH-IO Configuration                Parameters
-----
-><: Select Screen
↑↓: Select Item
Enter: Select
+/-: Change Opt.
F1: General Help
F2: Previous Values
F3: Optimized Defaults
F4: Save & Exit
ESC: Exit

Version 2.20.1271. Copyright (C) 2018 American Megatrends, Inc.
    
```

BIOS Menu 18: Chipset

5.4.1 System Agent (SA) Configuration

Use the **System Agent (SA) Configuration** menu (**BIOS Menu 19**) to configure the System Agent (SA) parameters.

```

Aptio Setup Utility - Copyright (C) 2018 American Megatrends, Inc.
Chipset
System Agent (SA) Configuration
VT-d                               Supported
> Memory Configuration
> Graphics Configuration
> PEG Port Configuration
Memory Configuration Parameters
-----
-><: Select Screen
↑↓: Select Item
Enter: Select
+/-: Change Opt.
F1: General Help
F2: Previous Values
F3: Optimized Defaults
F4: Save & Exit
ESC: Exit
Version 2.20.1271. Copyright (C) 2018 American Megatrends, Inc.
  
```

BIOS Menu 19: System Agent (SA) Configuration

5.4.1.1 Memory Configuration

Use the **Memory Configuration** submenu (**BIOS Menu 20**) to view memory information.

```

Aptio Setup Utility - Copyright (C) 2018 American Megatrends, Inc.
Chipset
Memory Configuration
CHA_DIMM0                           Populated & Enabled
  Size                             8192 MB (DDR4)
  Number of Ranks                    2
  Manufacturer                       Samsung
CHA_DIMM1                           Not Populated/Disabled
CHB_DIMM0                           Not Populated/Disabled
CHB_DIMM1                           Not Populated/Disabled
-----
-><: Select Screen
↑↓: Select Item
Enter: Select
+/-: Change Opt.
F1: General Help
F2: Previous Values
F3: Optimized Defaults
F4: Save & Exit
ESC: Exit
Version 2.20.1271. Copyright (C) 2018 American Megatrends, Inc.
  
```

BIOS Menu 20: Memory Configuration

IMBA-Q370 ATX Motherboard

5.4.1.2 Graphics Configuration

Use the **Graphics Configuration (BIOS Menu 21)** menu to configure the video device connected to the system.

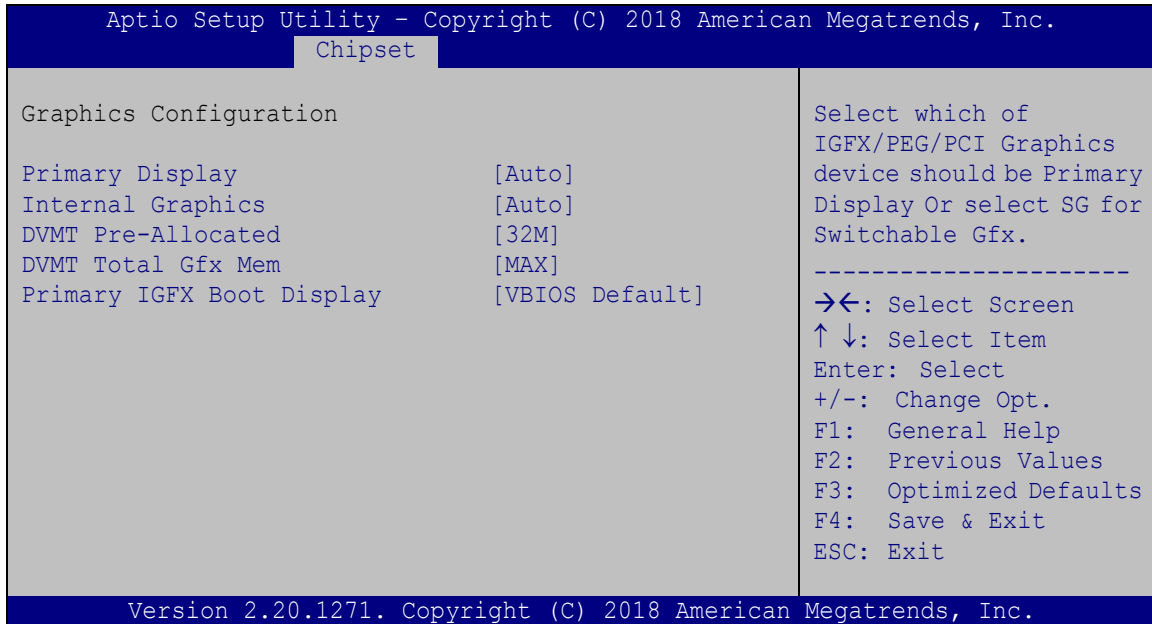

BIOS Menu 21: Graphics Configuration

→ Primary Display [Auto]

Use the **Primary Display** option to select the primary graphics controller the system uses.

The following options are available:

- Auto **Default**
- IGFX
- PEG
- PCIe

→ Internal Graphics [Auto]

Use the **Internal Graphics** option to configure whether to keep IGFX enabled. If user wants to support dual display by internal graphics and external graphics, this Internal Graphics option should be set to Enabled and the above Primary Display option should be set to IGFX.

- **Auto** **DEFAULT** Auto mode
- **Disabled** Disables IGFX.
- **Enabled** Enables IGFX.

→ DVMT Pre-Allocated [32M]

Use the **DVMT Pre-Allocated** option to set the amount of system memory allocated to the integrated graphics processor when the system boots. The system memory allocated can then only be used as graphics memory, and is no longer available to applications or the operating system. Configuration options are listed below:

- 32M **Default**
- 64M

→ DVMT Total Gfx Mem [MAX]

Use the **DVMT Total Gfx Mem** option to select DVMT5.0 total graphic memory size used by the internal graphic device. The following options are available:

- 128M
- 256M
- MAX **Default**

→ Primary IGFX Boot Display [VBIOS Default]

Use the **Primary IGFX Boot Display** option to select the display device used by the system when it boots. Configuration options are listed below.

- VBIOS Default **DEFAULT**
- DP++
- CRT
- DP1
- HDMI

IMBA-Q370 ATX Motherboard

5.4.1.3 PEG Port Configuration

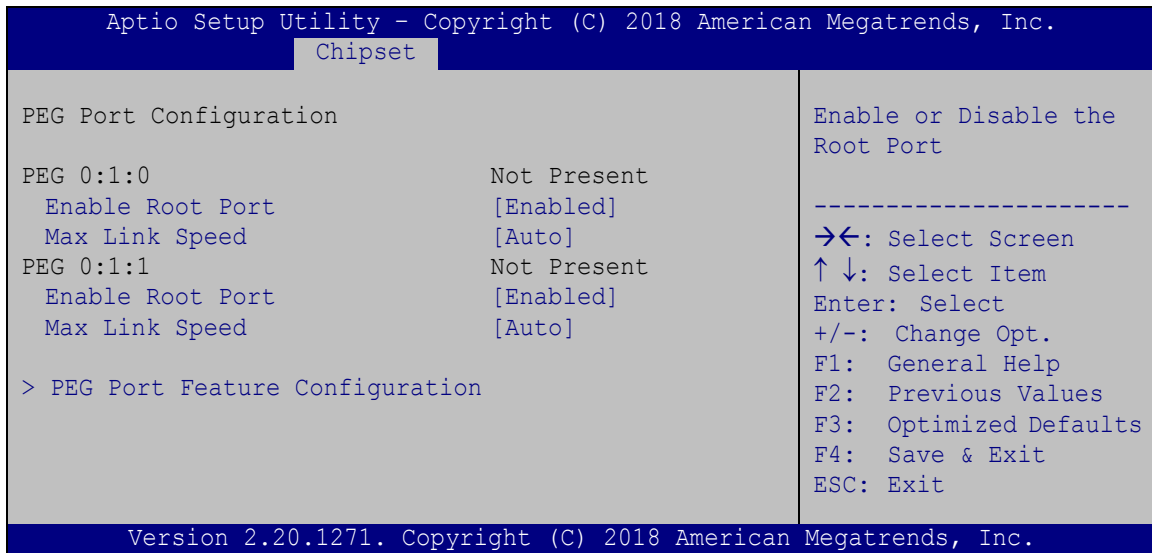

BIOS Menu 22: PEG Port Configuration

→ Enable Root Port [Enabled]

Use the **Enable Root Port** option to enable or disable the PCI Express (PEG) controller.

- **Disabled** Disables the PCI Express (PEG) controller.
- **Enabled** **DEFAULT** Enables the PCI Express (PEG) controller.

→ Max Link Speed [Auto]

Use the **Max Link Speed** option to select the maximum link speed of the PCI Express slot.

The following options are available:

- Auto **Default**
- Gen1
- Gen2
- Gen3

5.4.1.3.1 PEG Port Feature Configuration

Use the **PEG Port Feature Configuration** submenu (**BIOS Menu 23**) to configure the SA PCIe settings.

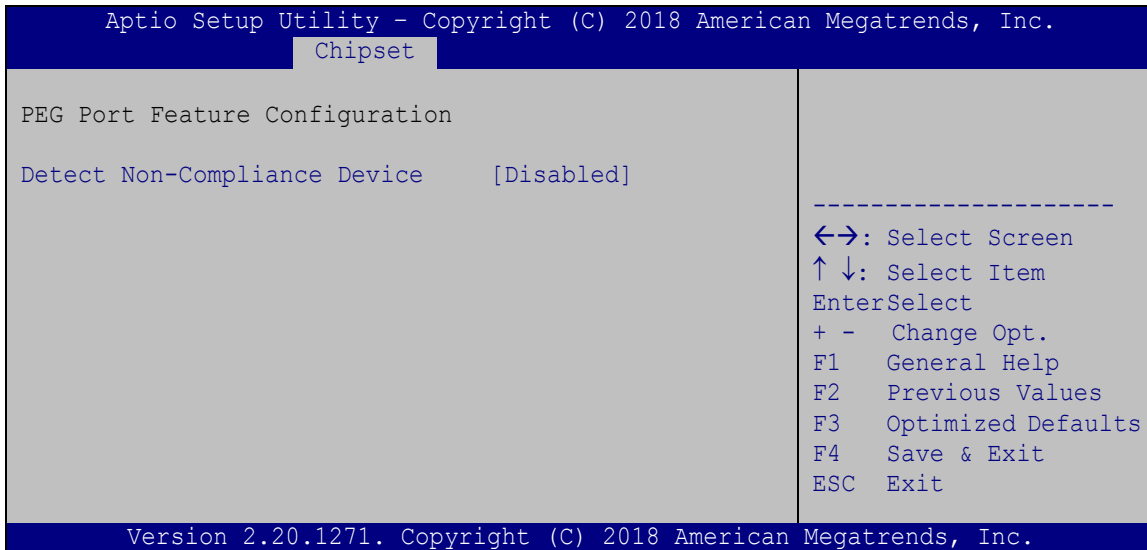

BIOS Menu 23: PEG Port Feature Configuration

➔ Detect Non-Compliance Device [Disabled]

Use the **Detect Non-Compliance Device** option to detect non-compliance PCIe device in PEG.

- ➔ **Disabled** **DEFAULT** Do not detect non-compliance PCIe device in PEG
- ➔ **Enabled** Detect non-compliance PCIe device in PEG

IMBA-Q370 ATX Motherboard

5.4.2 PCH-IO Configuration

Use the **PCH-IO Configuration** menu (**BIOS Menu 24**) to configure the PCH parameters.

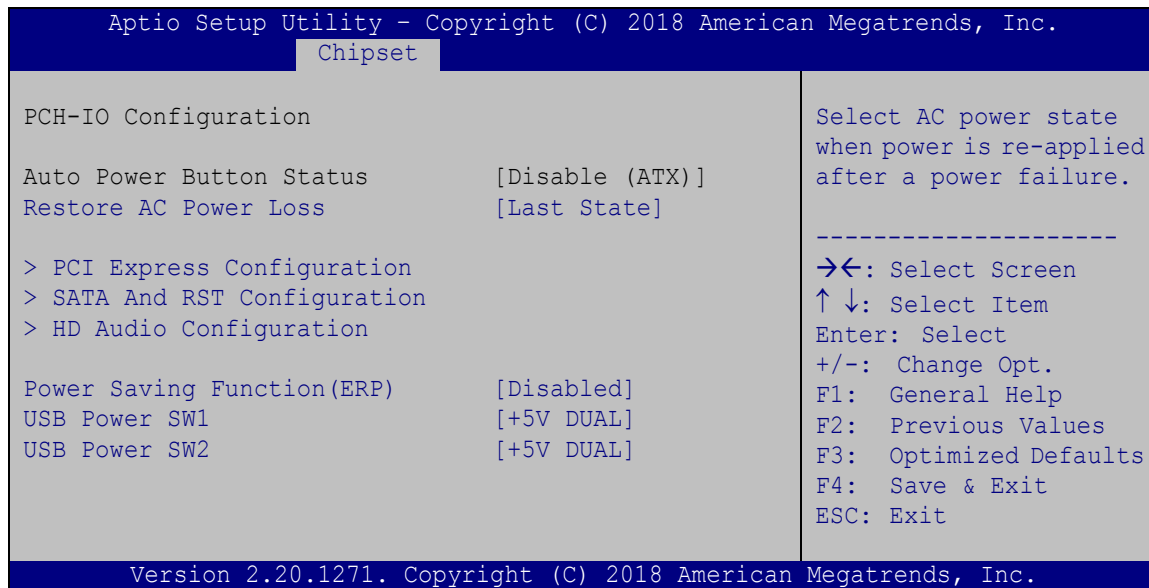

BIOS Menu 24: PCH-IO Configuration

→ Restore AC Power Loss [Last State]

Use the **Restore AC Power Loss** BIOS option to specify what state the system returns to if there is a sudden loss of power to the system.

- **Power Off** The system remains turned off
- **Power On** The system turns on
- **Last State** **DEFAULT** The system returns to its previous state. If it was on, it turns itself on. If it was off, it remains off.

→ Power Saving Function(ERP) [Disabled]

Use the **Power Saving Function(ERP)** BIOS option to enable or disable the power saving function.

- **Disabled** **DEFAULT** Power saving function is disabled.
- **Enabled** Power saving function is enabled. It will reduce power consumption when the system is off.

→ USB Power SW1 [+5V DUAL]

Use the **USB Power SW1** BIOS option to configure the USB power source for the corresponding USB connectors (Table 5-2).

→ **+5V DUAL** **DEFAULT** Sets the USB power source to +5V dual

→ **+5V** Sets the USB power source to +5V

→ USB Power SW2 [+5V DUAL]

Use the **USB Power SW2** BIOS option to configure the USB power source for the corresponding USB connectors (Table 5-2).

→ **+5V DUAL** **DEFAULT** Sets the USB power source to +5V dual

→ **+5V** Sets the USB power source to +5V

BIOS Options	Configured USB Ports
USB Power SW1	K/M_USB1 (external USB 2.0 ports) LAN1_USB1 (external USB 3.2 Gen 2 ports) LAN2_USB2 (external USB 3.2 Gen 1 ports)
USB Power SW2	USB1 (internal USB 2.0 ports) USB2 (internal USB 2.0 ports) USB3-1 (internal USB 3.2 Gen 1 ports)

Table 5-2: BIOS Options and Configured USB Ports

IMBA-Q370 ATX Motherboard

5.4.2.1 PCI Express Configuration

Use the **PCI Express Configuration** menu (**BIOS Menu 25**) to configure the PCI Express and M.2 slots.

```
Aptio Setup Utility - Copyright (C) 2018 American Megatrends, Inc.
Chipset
PCI Express Configuration
> PCIEX4_1 Slot
> PCIEX4_2 Slot
> PCIEX4_3 Slot
> M.2(A) Slot
> M.2(M) Slot

Select PCIEX4_3 slot
function.
Enable/Disable PCIEX4_3
Slot or SATA Port 3/4.

-----
-><: Select Screen
↑↓: Select Item
Enter: Select
+/-: Change Opt.
F1: General Help
F2: Previous Values
F3: Optimized Defaults
F4: Save & Exit
ESC: Exit

Version 2.20.1271. Copyright (C) 2018 American Megatrends, Inc.
```

BIOS Menu 25: PCI Express Configuration

5.4.2.1.1 PCIEX4_1 Slot, PCIEX4_2 Slot, PCIEX4_3 Slot and M.2 Slots

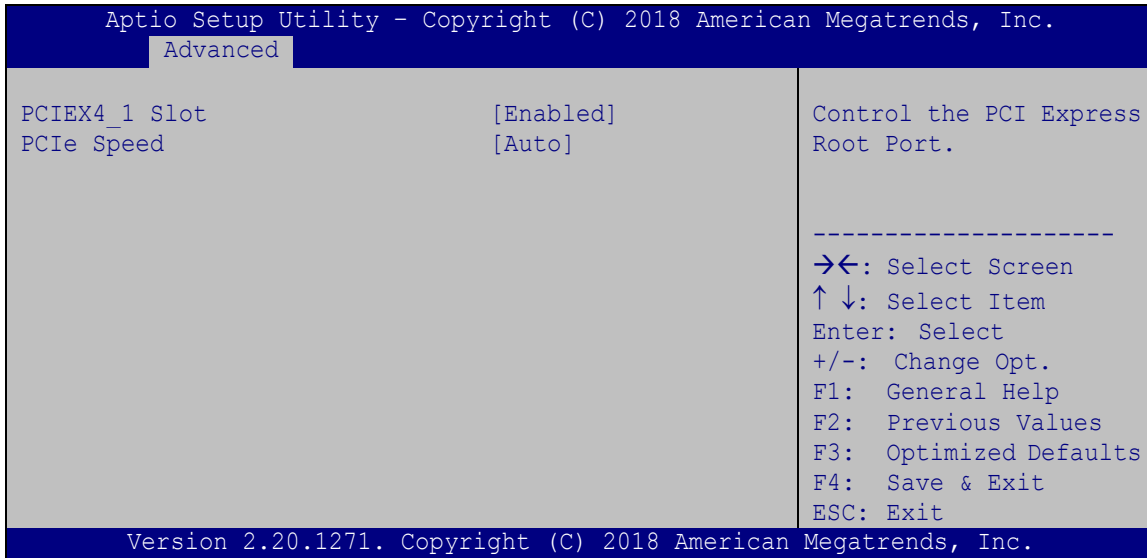

BIOS Menu 26: PCIe Slot Configuration Submenu

→ **PCIEX4_1 Slot [Enabled]**

Use the **PCIEX4_1 Slot** option to enable or disable the PCIEX4_1 PCI Express slot.

- **Disabled** Disables the PCIEX4_1 PCI Express slot.
- **Enabled** **DEFAULT** Enables the PCIEX4_1 PCI Express slot.

→ **PCIEX4_2 Slot [Enabled]**

Use the **PCIEX4_2 Slot** option to enable or disable the PCIEX4_2 PCI Express slot.

- **Disabled** Disables the PCIEX4_2 PCI Express slot.
- **Enabled** **DEFAULT** Enables the PCIEX4_2 PCI Express slot.

IMBA-Q370 ATX Motherboard

→ PCIEX4_3 Slot [Enabled]

Use the **PCIEX4_3 Slot** option to enable or disable the PCIEX4_3 PCI Express slot.

- **Disabled** Disables the PCIEX4_3 PCI Express slot.
- **Enabled** **DEFAULT** Enables the PCIEX4_3 PCI Express slot.

→ M.2(A) Slot [Enabled]

Use the **M.2(A) Slot** option to enable or disable the M.2 2230 A-key slot.

- **Disabled** Disables the M.2 2230 A-key slot.
- **Enabled** **DEFAULT** Enables the M.2 2230 A-key slot.

→ M.2(M) Slot [Enabled]

Use the **M.2(M) Slot** option to enable or disable the M.2 2280 M-key slot.

- **Disabled** Disables the M.2 2280 M-key slot.
- **Enabled** **DEFAULT** Enables the M.2 2280 M-key slot.

→ PCIe Speed [Auto]

Use this option to select the support type of the PCI Express slots. The following options are available:

- Auto **Default**
- Gen1
- Gen2
- Gen3

5.4.2.2 SATA Configuration

Use the **SATA Configuration** menu (**BIOS Menu 27**) to change and/or set the configuration of the SATA devices installed in the system.

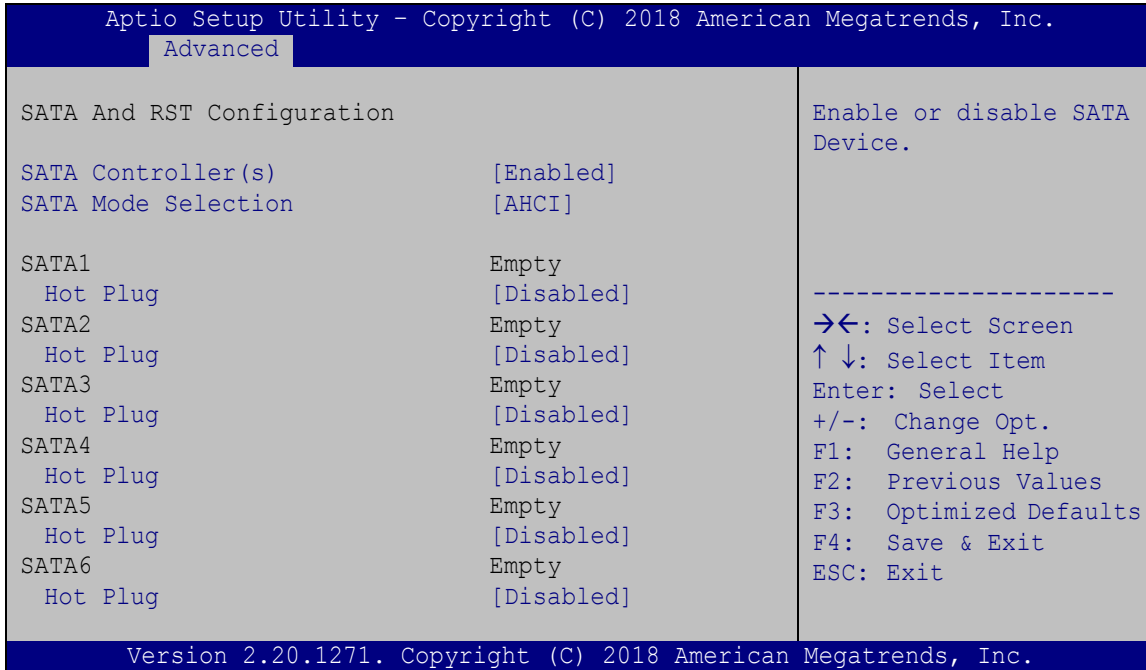

BIOS Menu 27: SATA Configuration

→ SATA Controller(s) [Enabled]

Use the **SATA Controller(s)** option to configure the SATA controller(s).

- **Enabled** **DEFAULT** Enables the on-board SATA controller(s).
- **Disabled** Disables the on-board SATA controller(s).

→ SATA Mode Selection [AHCI]

Use the **SATA Mode Selection** option to determine how the SATA devices operate.

- **AHCI** **DEFAULT** Configures SATA devices as AHCI device.

IMBA-Q370 ATX Motherboard

- **Intel RST Premium With Intel Optane System Acceleration** Configures SATA devices to the Intel RST Premium With Intel Optane System Acceleration mode.

→ **Hot Plug [Disabled]**

Use the **Hot Plug** option to designate the correspondent SATA port as hot-pluggable.

- **Disabled** **DEFAULT** Disables the hot-pluggable function of the SATA port.
- **Enabled** Designates the SATA port as hot-pluggable.

5.4.2.3 HD Audio Configuration

Use the **HD Audio Configuration** menu (**BIOS Menu 28**) to configure the PCH Azalia settings.

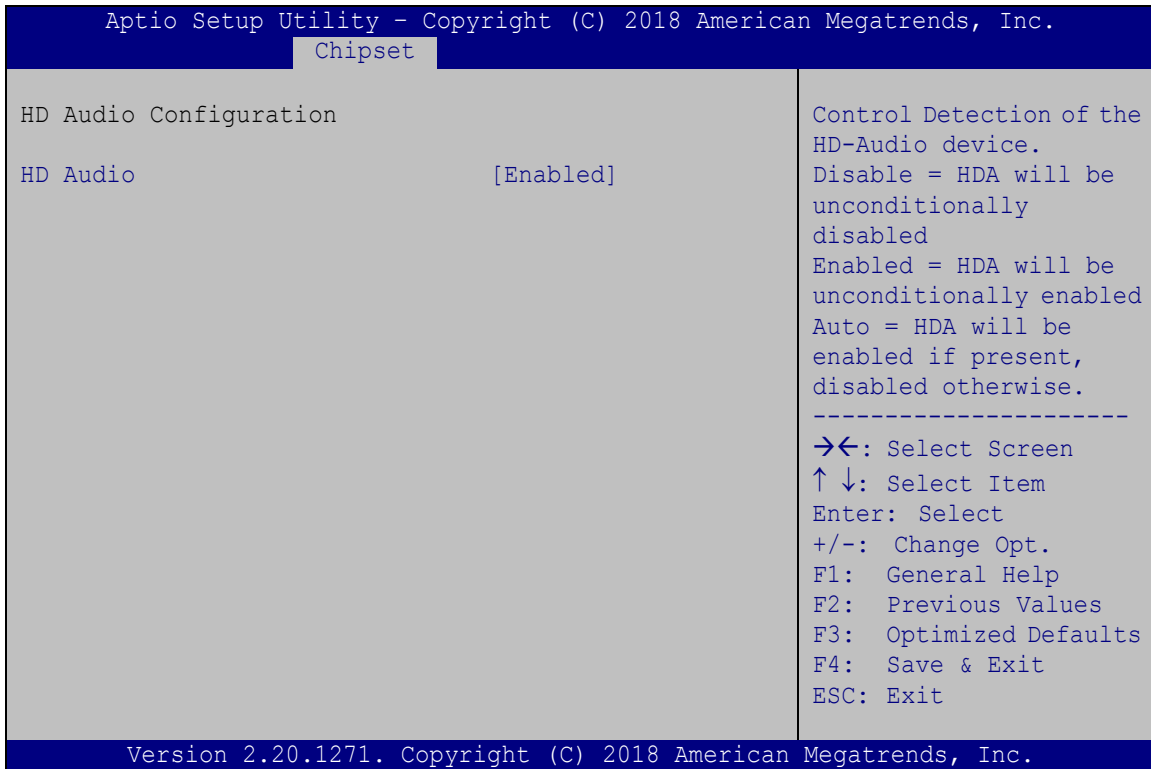

BIOS Menu 28: HD Audio Configuration

→ HD Audio [Auto]

Use the **HD Audio** option to enable or disable the High Definition Audio controller.

- **Disabled** The onboard High Definition Audio controller is disabled.
- **Enabled** **DEFAULT** The onboard High Definition Audio controller is enabled.

IMBA-Q370 ATX Motherboard

5.5 Security

Use the **Security** menu (**BIOS Menu 29**) to set system and user passwords.

```

Aptio Setup Utility - Copyright (C) 2018 American Megatrends, Inc.
Main   Advanced  Chipset  Security  Boot   Save & Exit

Password Description

If ONLY the Administrator's password is set,
then this only limits access to Setup and is
only asked for when entering Setup.
If ONLY the User's password is set, then this
is a power on password and must be entered to
boot or enter Setup. In Setup the User will
have Administrator rights.
The password length must be:
Minimum length           3
Maximum length          20

Administrator Password
User Password

Set Administrator
Password

-----
-><: Select Screen
↑↓: Select Item
Enter: Select
+/-: Change Opt.
F1:  General Help
F2:  Previous Values
F3:  Optimized Defaults
F4:  Save & Exit
ESC: Exit

Version 2.20.1271. Copyright (C) 2018 American Megatrends, Inc.
  
```

BIOS Menu 29: Security

➔ Administrator Password

Use the **Administrator Password** to set or change a administrator password.

➔ User Password

Use the **User Password** to set or change a user password.

5.6 Boot

Use the **Boot** menu (**BIOS Menu 30**) to configure system boot options.

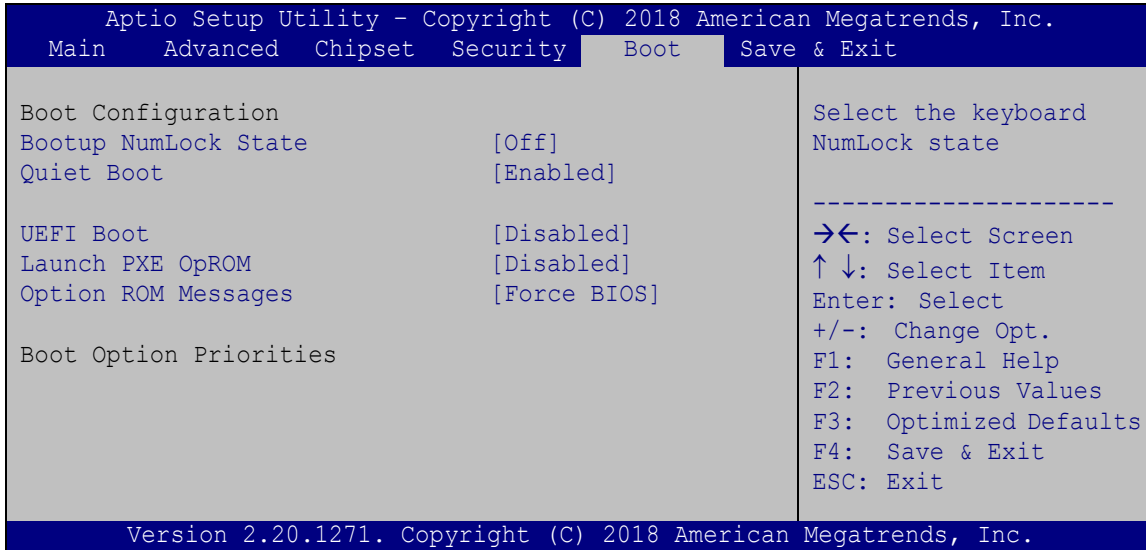

BIOS Menu 30: Boot

→ Bootup NumLock State [Off]

Use the **Bootup NumLock State** BIOS option to specify if the number lock setting must be modified during boot up.

→ On

Allows the Number Lock on the keyboard to be enabled automatically when the computer system boots up. This allows the immediate use of the 10-key numeric keypad located on the right side of the keyboard. To confirm this, the Number Lock LED light on the keyboard is lit.

→ Off **DEFAULT**

Does not enable the keyboard Number Lock automatically. To use the 10-keys on the keyboard, press the Number Lock key located on the upper left-hand corner of the 10-key pad. The Number Lock LED on the keyboard lights up when the Number Lock is engaged.

IMBA-Q370 ATX Motherboard

→ Quiet Boot [Enabled]

Use the **Quiet Boot** BIOS option to select the screen display when the system boots.

- **Disabled** Normal POST messages displayed
- **Enabled** **DEFAULT** OEM Logo displayed instead of POST messages

→ UEFI Boot [Disabled]

Use the **UEFI Boot** option to enable or disable to boot from the UEFI devices.

- **Disabled** **DEFAULT** Boot from UEFI devices is disabled.
- **Enabled** Boot from UEFI devices is enabled.

→ Launch PXE OpROM [Disabled]

Use the **Launch PXE OpROM** option to enable or disable boot option for legacy network devices.

- **Disabled** **DEFAULT** Ignore all PXE Option ROMs
- **Enabled** Load PXE Option ROMs.

→ Option ROM Messages [Force BIOS]

Use the **Option ROM Messages** option to set the Option ROM display mode.

- **Force BIOS** **DEFAULT** Sets display mode to force BIOS.
- **Keep Current** Sets display mode to current.

5.7 Save & Exit

Use the **Safe & Exit** menu (**BIOS Menu 31**) to load default BIOS values, optimal failsafe values and to save configuration changes.

```
Aptio Setup Utility - Copyright (C) 2018 American Megatrends, Inc.
Main   Advanced Chipset Security Boot   Save & Exit
Save Changes and Reset
Discard Changes and Reset

Restore Defaults
Save as User Defaults
Restore User Defaults

Exit the system after
saving the changes.

-----
-><: Select Screen
↑↓: Select Item
Enter: Select
+/-: Change Opt.
F1: General Help
F2: Previous Values
F3: Optimized Defaults
F4: Save & Exit
ESC: Exit

Version 2.20.1271. Copyright (C) 2018 American Megatrends, Inc.
```

BIOS Menu 31: Save & Exit

→ Save Changes and Reset

Use the **Save Changes and Reset** option to save the changes made to the BIOS options and reset the system.

→ Discard Changes and Reset

Use the **Discard Changes and Reset** option to exit the system without saving the changes made to the BIOS configuration setup program.

→ Restore Defaults

Use the **Restore Defaults** option to load the optimal default values for each of the parameters on the Setup menus. **F3 key can be used for this operation.**

→ Save as User Defaults

Use the **Save as User Defaults** option to save the changes done so far as user defaults.

→ Restore User Defaults

Use the **Restore User Defaults** option to restore the user defaults to all the setup options.

Appendix

A

Regulatory Compliance

DECLARATION OF CONFORMITY

This equipment has been tested and found to comply with specifications for CE marking. If the user modifies and/or installs other devices in the equipment, the CE conformity declaration may no longer apply.

FCC WARNING

This equipment complies with Part 15 of the FCC Rules. Operation is subject to the following two conditions:

- This device may not cause harmful interference, and
- This device must accept any interference received, including interference that may cause undesired operation.

This equipment has been tested and found to comply with the limits for a Class A digital device, pursuant to part 15 of the FCC Rules. These limits are designed to provide reasonable protection against harmful interference when the equipment is operated in a commercial environment. This equipment generates, uses, and can radiate radio frequency energy and, if not installed and used in accordance with the instruction manual, may cause harmful interference to radio communications. Operation of this equipment in a residential area is likely to cause harmful interference in which case the user will be required to correct the interference at his own expense.

Appendix

B

Product Disposal

**CAUTION:**

Risk of explosion if battery is replaced by an incorrect type. Only certified engineers should replace the on-board battery.

Dispose of used batteries according to instructions and local regulations.

- Outside the European Union–If you wish to dispose of used electrical and electronic products outside the European Union, please contact your local authority so as to comply with the correct disposal method.
- Within the European Union–The device that produces less waste and is easier to recycle is classified as electronic device in terms of the European Directive 2012/19/EU (WEEE), and must not be disposed of as domestic garbage.

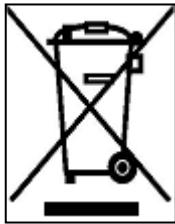

EU-wide legislation, as implemented in each Member State, requires that waste electrical and electronic products carrying the mark (left) must be disposed of separately from normal household waste. This includes monitors and electrical accessories, such as signal cables or power cords. When you need to dispose of your device, please follow the guidance of your local authority, or ask the shop where you purchased the product. The mark on electrical and electronic products only applies to the current European Union Member States.

Please follow the national guidelines for electrical and electronic product disposal.

Appendix

C

BIOS Options

Below is a list of BIOS configuration options in the BIOS chapter.

<input type="checkbox"/>	System Date [xx/xx/xx]	80
<input type="checkbox"/>	System Time [xx:xx:xx]	81
<input type="checkbox"/>	Intel (VMX) Virtualization Technology [Disabled]	82
<input type="checkbox"/>	Active Processor Cores [All]	83
<input type="checkbox"/>	Intel(R) SpeedStep(tm) [Enabled]	83
<input type="checkbox"/>	C states [Disabled]	83
<input type="checkbox"/>	Unconfigure ME [Disabled]	84
<input type="checkbox"/>	Security Device Support [Disable]	85
<input type="checkbox"/>	ACPI Sleep State [S3 (Suspend to RAM)]	86
<input type="checkbox"/>	PC Health Status	87
<input type="checkbox"/>	CPU_FAN1 Smart Fan Control/SYS_FAN1 Smart Fan Control [Auto Mode]	88
<input type="checkbox"/>	Auto mode fan start/off temperature	89
<input type="checkbox"/>	Auto mode fan start PWM	89
<input type="checkbox"/>	Auto mode fan slope PWM	89
<input type="checkbox"/>	Case Open Beep [Disabled]	89
<input type="checkbox"/>	Serial Port [Enabled]	90
<input type="checkbox"/>	Change Settings [Auto]	90
<input type="checkbox"/>	Serial Port [Enabled]	91
<input type="checkbox"/>	Change Settings [Auto]	91
<input type="checkbox"/>	Serial Port [Enabled]	92
<input type="checkbox"/>	Change Settings [Auto]	92
<input type="checkbox"/>	Serial Port [Enabled]	93
<input type="checkbox"/>	Change Settings [Auto]	93
<input type="checkbox"/>	Serial Port [Enabled]	94
<input type="checkbox"/>	Change Settings [Auto]	94
<input type="checkbox"/>	Transfer Mode [RS232]	96
<input type="checkbox"/>	Serial Port [Enabled]	96
<input type="checkbox"/>	Change Settings [Auto]	96
<input type="checkbox"/>	Transfer Mode [RS232]	97
<input type="checkbox"/>	Parallel Port [Enabled]	98
<input type="checkbox"/>	Device Mode [STD Printer Mode]	98
<input type="checkbox"/>	Wake system with Fixed Time [Disabled]	99
<input type="checkbox"/>	Console Redirection [Disabled]	101

IMBA-Q370 ATX Motherboard

<input type="checkbox"/>	Terminal Type [ANSI].....	101
<input type="checkbox"/>	Bits per second [115200].....	101
<input type="checkbox"/>	Data Bits [8]	101
<input type="checkbox"/>	Parity [None].....	102
<input type="checkbox"/>	Stop Bits [1].....	102
<input type="checkbox"/>	Legacy Serial Redirection Port [COM1].....	103
<input type="checkbox"/>	Legacy USB Support [Enabled].....	104
<input type="checkbox"/>	Auto Recovery Function [Disabled].....	106
<input type="checkbox"/>	Primary Display [Auto]	109
<input type="checkbox"/>	Internal Graphics [Auto].....	110
<input type="checkbox"/>	DVMT Pre-Allocated [32M]	110
<input type="checkbox"/>	DVMT Total Gfx Mem [MAX].....	110
<input type="checkbox"/>	Primary IGFX Boot Display [VBIOS Default]	110
<input type="checkbox"/>	Enable Root Port [Enabled]	111
<input type="checkbox"/>	Max Link Speed [Auto]	111
<input type="checkbox"/>	Detect Non-Compliance Device [Disabled]	112
<input type="checkbox"/>	Restore AC Power Loss [Last State]	113
<input type="checkbox"/>	Power Saving Function(ERP) [Disabled].....	113
<input type="checkbox"/>	USB Power SW1 [+5V DUAL].....	114
<input type="checkbox"/>	USB Power SW2 [+5V DUAL].....	114
<input type="checkbox"/>	PCIEX4_1 Slot [Enabled]	116
<input type="checkbox"/>	PCIEX4_2 Slot [Enabled]	116
<input type="checkbox"/>	PCIEX4_3 Slot [Enabled]	117
<input type="checkbox"/>	M.2(A) Slot [Enabled].....	117
<input type="checkbox"/>	M.2(M) Slot [Enabled]	117
<input type="checkbox"/>	PCIe Speed [Auto].....	117
<input type="checkbox"/>	SATA Controller(s) [Enabled]	118
<input type="checkbox"/>	SATA Mode Selection [AHCI].....	118
<input type="checkbox"/>	Hot Plug [Disabled]	119
<input type="checkbox"/>	HD Audio [Auto]	120
<input type="checkbox"/>	Administrator Password	121
<input type="checkbox"/>	User Password	121
<input type="checkbox"/>	Bootup NumLock State [Off].....	122
<input type="checkbox"/>	Quiet Boot [Enabled]	123
<input type="checkbox"/>	UEFI Boot [Disabled]	123

<input type="checkbox"/> Launch PXE OpROM [Disabled]	123
<input type="checkbox"/> Option ROM Messages [Force BIOS]	123
<input type="checkbox"/> Save Changes and Reset	124
<input type="checkbox"/> Discard Changes and Reset	124
<input type="checkbox"/> Restore Defaults	124
<input type="checkbox"/> Save as User Defaults	124
<input type="checkbox"/> Restore User Defaults	124

Appendix

D

Digital I/O Interface

D.1 Introduction

The DIO connector on the IMBA-Q370 is interfaced to GPIO ports on the Super I/O chipset. The digital inputs and digital outputs are generally control signals that control the on/off circuit of external devices or TTL devices. Data can be read or written to the selected address to enable the DIO functions.



NOTE:

For further information, please refer to the datasheet for the Super I/O chipset.

The BIOS interrupt call **INT 15H** controls the digital I/O.

INT 15H:

AH – 6FH
<u>Sub-function:</u>
AL – 8 :Set the digital port as INPUT
AL :Digital I/O input value

IMBA-Q370 ATX Motherboard

D.2 Assembly Language Sample 1

```

MOV     AX, 6F08H      ;setting the digital port as input
INT     15H           ;

```

AL low byte = value

AH – 6FH
<u>Sub-function:</u>
AL – 9 :Set the digital port as OUTPUT
BL :Digital I/O input value

D.3 Assembly Language Sample 2

```

MOV     AX, 6F09H      ;setting the digital port as output
MOV     BL, 09H        ;digital value is 09H
INT     15H           ;

```

Digital Output is 1001b

Appendix

E

Watchdog Timer

IMBA-Q370 ATX Motherboard



NOTE:

The following discussion applies to DOS environment. Contact IEI support or visit the IEI website for specific drivers for other operating systems.

The Watchdog Timer is provided to ensure that standalone systems can always recover from catastrophic conditions that cause the CPU to crash. This condition may have occurred by external EMIs or a software bug. When the CPU stops working correctly, Watchdog Timer either performs a hardware reset (cold boot) or a Non-Maskable Interrupt (NMI) to bring the system back to a known state.

A BIOS function call (INT 15H) is used to control the Watchdog Timer.

INT 15H:

AH – 6FH Sub-function:	
AL – 2:	Sets the Watchdog Timer's period.
BL:	Time-out value (Its unit-second is dependent on the item "Watchdog Timer unit select" in CMOS setup).

Table E-1: AH-6FH Sub-function

Call sub-function 2 to set the time-out period of Watchdog Timer first. If the time-out value is not zero, the Watchdog Timer starts counting down. When the timer value reaches zero, the system resets. To ensure that this reset condition does not occur, calling sub-function 2 must periodically refresh the Watchdog Timer. However, the watchdog timer is disabled if the time-out value is set to zero.

A tolerance of at least 10% must be maintained to avoid unknown routines within the operating system (DOS), such as disk I/O that can be very time-consuming.



NOTE:

When exiting a program it is necessary to disable the Watchdog Timer, otherwise the system resets.

EXAMPLE PROGRAM:

; INITIAL TIMER PERIOD COUNTER

;

W_LOOP:

;

```

MOV      AX, 6F02H      ;setting the time-out value
MOV      BL, 30         ;time-out value is 48 seconds
INT      15H
    
```

;

; ADD THE APPLICATION PROGRAM HERE

;

```

CMP      EXIT_AP, 1     ;is the application over?
JNE      W_LOOP        ;No, restart the application
    
```

```

MOV      AX, 6F02H      ;disable Watchdog Timer
MOV      BL, 0         ;
INT      15H
    
```

;

; EXIT ;

Appendix

F

Intel® Matrix Storage Manager

F.1 Introduction

The IMBA-Q370 can provide data protection for serial ATA (SATA) disks via the Intel® Matrix Storage Manager using one of three fault-tolerant RAID levels: RAID 1, 5 or 10. When using two hard drives, matrix RAID allows RAID 0 and RAID 1 functions to be combined, where critical files can be stored on RAID 1, and RAID 0 can be used for non-critical items such as software. RAID 5 and RAID 0 can be combined to provide higher performance, capacity, and fault tolerance.



CAUTION!

A configured RAID volume (which may consist of multiple hard drives) appears to an operating system as a contingent storage space. The operating system will not be able to distinguish the physical disk drives contained in a RAID configuration.

F.1.1 Precautions

One key benefit a RAID configuration brings is that a single hard drive can fail within a RAID array without damaging data. With RAID1 array, a failed drive can be replaced and the RAID configuration restored.



WARNING!

Irrecoverable data loss occurs if a working drive is removed when trying to remove a failed drive. It is strongly recommended to mark the physical connections of all SATA disk drives. Drive locations can be identified by attaching stickers to the drive bays. If a drive member of a RAID array should fail, the failed drive can then be correctly identified.

IMBA-Q370 ATX Motherboard



CAUTION!

Do not accidentally disconnect the SATA drive cables. Carefully route the cables within the chassis to avoid system down time.

F.2 Features and Benefits

- Supports RAID levels 0, 1, 5 and 10
- Supports connectivity to two or more disk drives

F.3 Accessing the Intel® Matrix Storage Manager

To access the Intel® Matrix Storage Manager, please follow the steps below.

Step 1: Connect SATA drives to the system. Connect two or more SATA drives to the system. Make sure the drives have the same capacity, are the same type and have the same speed.



NOTE:

Make sure the SATA drives are EXACTLY the same when they are configured in a RAID configuration. If they are not the same size, disk drive capacity is sacrificed and overall performance affected.

Step 2: Enable SATA drives in BIOS. Start the computer and access the BIOS setup program. Enable RAID support for all SATA devices. Refer to the applicable BIOS configuration section in this user manual.

Step 3: Configure “Option ROM Messages” BIOS option to Force BIOS. This is to allow the “Press <CTRL+I> to enter Configuration Utility.....” message to appear during the POST. Refer to the applicable BIOS configuration section in this user manual.

- Step 4: Save and Exit BIOS.** After the SATA support option is enabled, save and exit the BIOS.
- Step 5: Reboot the system.** Reboot the system after saving and exiting the BIOS.
- Step 6: Press Ctrl+I. during the system boot process.** Press Ctrl+I when prompted to enter the RAID configuration software.
- Step 7: Configure the RAID settings.** Use the Intel® Matrix Storage Manager to configure the RAID array. Brief descriptions of configuration options are given below.

F.4 Installing the Operating System to the RAID Array

To install the operating system to the RAID array some extra steps are necessary during the installation process.

- Step 1: Prepare a RAID driver floppy disk on another computer.** If installing on the RAID array a RAID driver floppy disk must be made. The RAID driver floppy disk utility is on the CD in the “8-RST” folder. The floppy disk will be formatted and the drivers installed.
- Step 2: Restart the system with a floppy drive attached.** Attach a normal floppy drive or USB floppy drive to the system.
- Step 3: Press F6 when prompted.** During the installation process, Windows OS prompts the user to press F6 to install the RAID drivers. Press F6 and choose from the drivers on the floppy disk.
- Step 4: Install the OS.** Continue with OS installation as usual.

Appendix

G

Error Beep Code

G.1 PEI Beep Codes

Number of Beeps	Description
1	Memory not Installed
1	Memory was installed twice (InstallPeiMemory routine in PEI Core called twice)
2	Recovery started
3	DXE IPL was not found
3	DXE Core Firmware Volume was not found
4	Recovery failed
4	S3 Resume failed
7	Reset PPI is not available

G.2 DXE Beep Codes

Number of Beeps	Description
1	Invalid password
4	Some of the Architectural Protocols are not available
5	No Console Output Devices are found
5	No Console Input Devices are found
6	Flash update is failed
7	Reset protocol is not available
8	Platform PCI resource requirements cannot be met

**NOTE:**

If you have any question, please contact IEI for further assistance.

Appendix

H

Hazardous Materials Disclosure

H.1 RoHS II Directive (2015/863/EU)

The details provided in this appendix are to ensure that the product is compliant with the RoHS II Directive (2015/863/EU). The table below acknowledges the presences of small quantities of certain substances in the product, and is applicable to RoHS II Directive (2015/863/EU).

Please refer to the following table.

Part Name	Toxic or Hazardous Substances and Elements									
	Lead (Pb)	Mercury (Hg)	Cadmium (Cd)	Hexavalent Chromium (CR(VI))	Polybrominated Biphenyls (PBB)	Polybrominated Diphenyl Ethers (PBDE)	Bis(2-ethylhexyl) phthalate (DEHP)	Butyl benzyl phthalate (BBP)	Dibutyl phthalate (DBP)	Diisobutyl phthalate (DIBP)
Housing	O	O	O	O	O	O	O	O	O	O
Printed Circuit Board	O	O	O	O	O	O	O	O	O	O
Metal Fasteners	O	O	O	O	O	O	O	O	O	O
Cable Assembly	O	O	O	O	O	O	O	O	O	O
Fan Assembly	O	O	O	O	O	O	O	O	O	O
Power Supply Assemblies	O	O	O	O	O	O	O	O	O	O
Battery	O	O	O	O	O	O	O	O	O	O
<p>O: This toxic or hazardous substance is contained in all of the homogeneous materials for the part is below the limit requirement in Directive (EU) 2015/863.</p> <p>X: This toxic or hazardous substance is contained in at least one of the homogeneous materials for this part is above the limit requirement in Directive (EU) 2015/863.</p>										

IMBA-Q370 ATX Motherboard

H.2 China RoHS

此附件旨在确保本产品符合中国 RoHS 标准。以下表格标示此产品中某有毒物质的含量符合中国 RoHS 标准规定的限量要求。

本产品上会附有“环境友好使用期限”的标签，此期限是估算这些物质“不会有泄漏或突变”的年限。本产品可能包含有较短的环境友好使用期限的可替换元件，像是电池或灯管，这些元件将会单独标示出来。

部件名称	有毒有害物质或元素					
	铅 (Pb)	汞 (Hg)	镉 (Cd)	六价铬 (CR(VI))	多溴联苯 (PBB)	多溴二苯醚 (PBDE)
壳体	○	○	○	○	○	○
印刷电路板	○	○	○	○	○	○
金属螺帽	○	○	○	○	○	○
电缆组装	○	○	○	○	○	○
风扇组装	○	○	○	○	○	○
电力供应组装	○	○	○	○	○	○
电池	○	○	○	○	○	○

○: 表示该有毒有害物质在该部件所有物质材料中的含量均在 SJ/T11364-2014 與 GB/T26572-2011 标准规定的限量要求以下。

X: 表示该有毒有害物质至少在该部件的某一均质材料中的含量超出 SJ/T11364-2014 與 GB/T26572-2011 标准规定的限量要求。