

EMPL-G2P3 mPCIe to dual PoE module

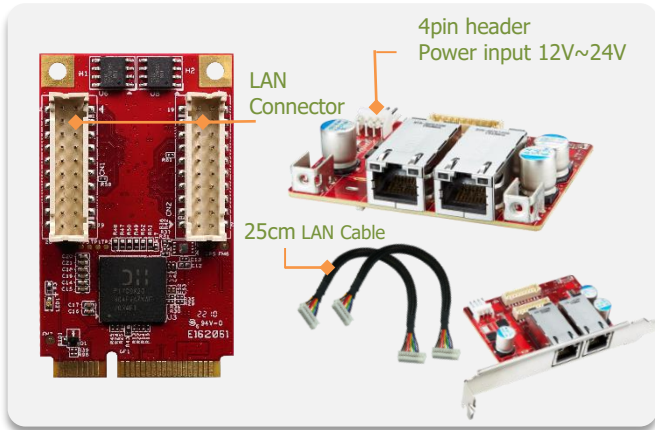

Features

- Supports dual GbE LAN ports
- Two independent PSE channels
- Supports 12V~24V power input via 4pin header
- Complies with IEEE 802.3af, up to 15.4W at 52V per PoE port
- Complies with EN61000-4-2 (ESD) Air-15kV, Contact-8kV
- Optional terminal mounting hole or bracket for daughter board
- Optional Industrial Temperature (-40°C to +85°C) support
- 30μ " golden finger, 3-year warranty
- Industrial design, manufactured in innodisk Taiwan

Mechanical Drawing

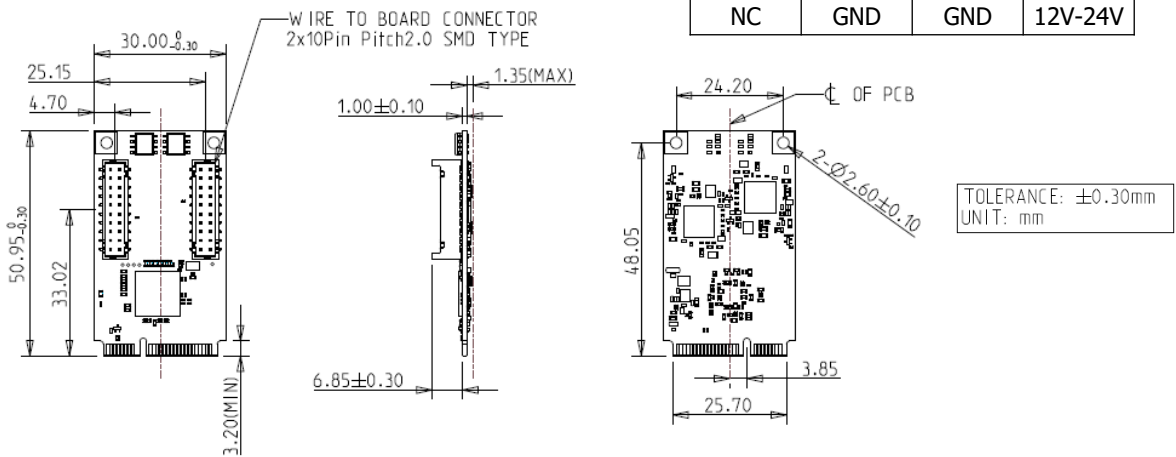

Specifications

Headquarters (Taiwan)

5F., No.237, Sec. 1, Datong Rd.,
Xizhi Dist., New Taipei City 221,
Taiwan

Tel: +886-2-7703-3000
Email: sales@innodisk.com

Branch Offices:

USA

usasales@innodisk.com
+1-510-770-9421

Europe

eusales@innodisk.com
+31-40-3045-400

Japan

jpsales@innodisk.com
+81-3-6667-0161

China

sales_cn@innodisk.com
+86-755-2167-3689

www.innodisk.com

© 2020 Innodisk Corporation.
All right reserved. Specifications
are subject to change without
prior notice.

November 26, 2022

Form-Factor	mPCIe
Input I/F	PCI Express 2.1 x 1
Output I/F	PoE x 2
Output Connector	RJ45 x 2
Power Consumption	LAN: MAX: 2.854W (3.3V, 865mA) PoE: MAX: 30W
Dimension (WxLxH)	Main Board: 30 x 50.9 x 9.2 mm Daughter Board: 72.7 x 56.3 x 22.07 mm
Temperature	Operation: STD: 0°C ~ +70°C. W/T: -40°C ~ +85°C Storage: -55°C ~ +95°C
Environment	Vibration: 5G @7~2000Hz, Shock: 50G @ 0.5ms
Notes	Please download driver from Intel official website. Windows: 10 (64bit), Linux (igc): kernel 5.x version
Limitations	*Linux kernel rebuild is needed (modify igc driver) if version < 5.15 *Not recommend used in VMware ESXi due to High Latency *Not support Intel vPro

Order information

EMPL-G2P3-C1 (Mounting hole, 4pin header, Standard Temp.)

EMPL-G2P3-W1 (Mounting hole, 4pin header, Wide Temp.)

EMPL-G2P3-C2 (Bracket, 4pin header, Standard Temp.)

EMPL-G2P3-W2 (Bracket, 4pin header, Wide Temp.) www.innodisk.com
mPCIe to dual PoE module

EMPL-G2P3-C1/W1 Daughter Board and Mechanical Drawing

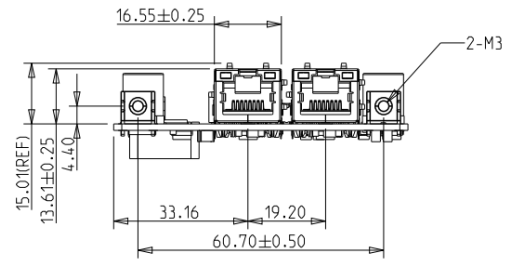
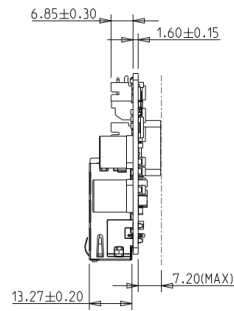
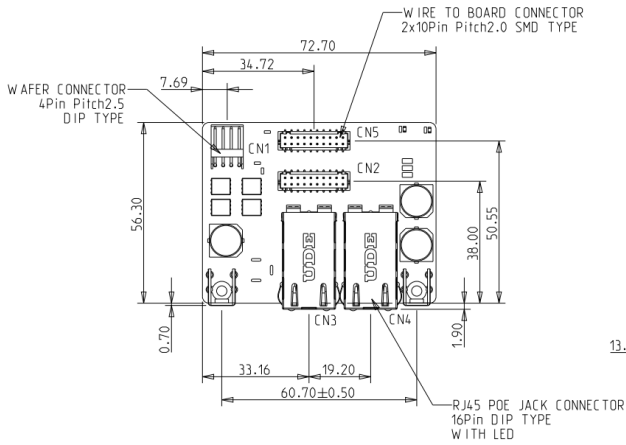
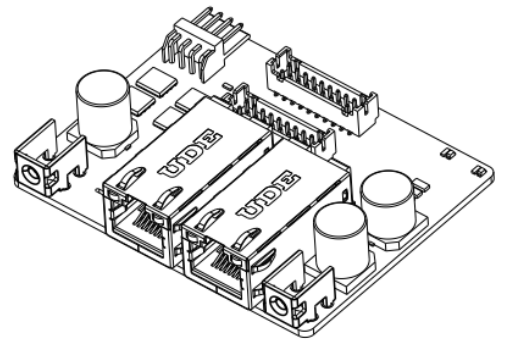
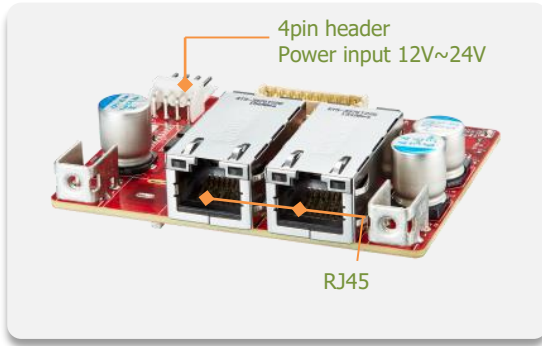

EMPL-G2P3-C2/W2 Daughter Board and Mechanical Drawing

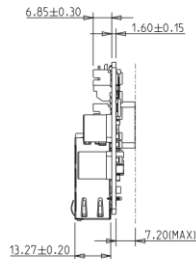
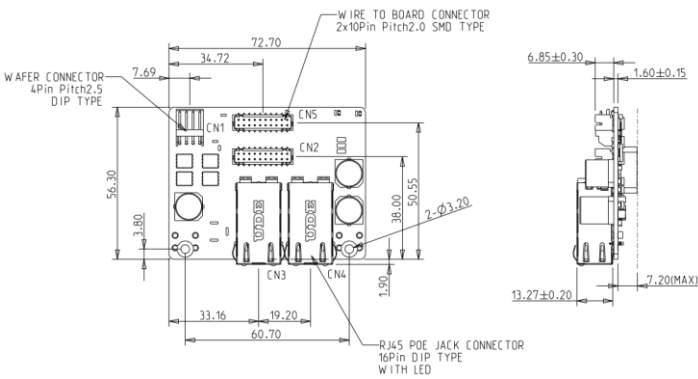
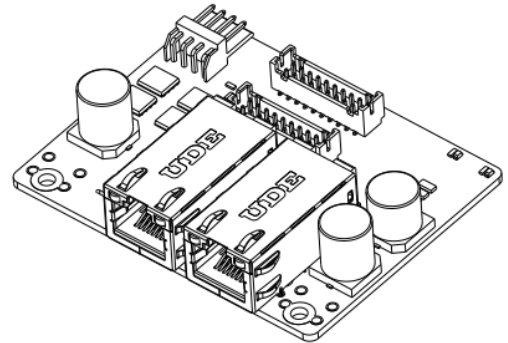
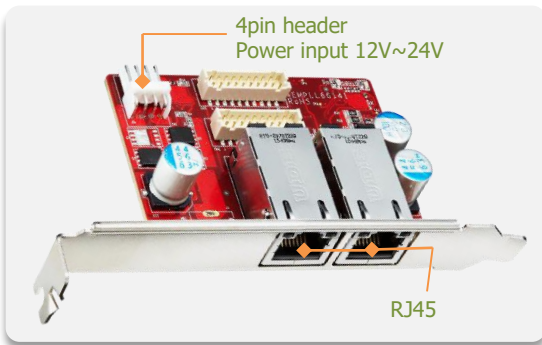

Bracket

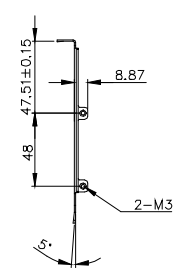
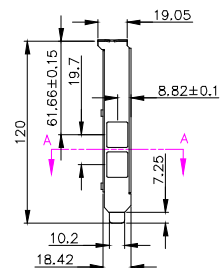
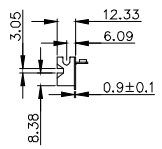
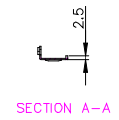
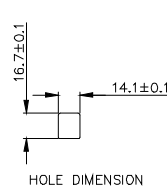

TOLERANCE: ±0.20mm