

User Manual

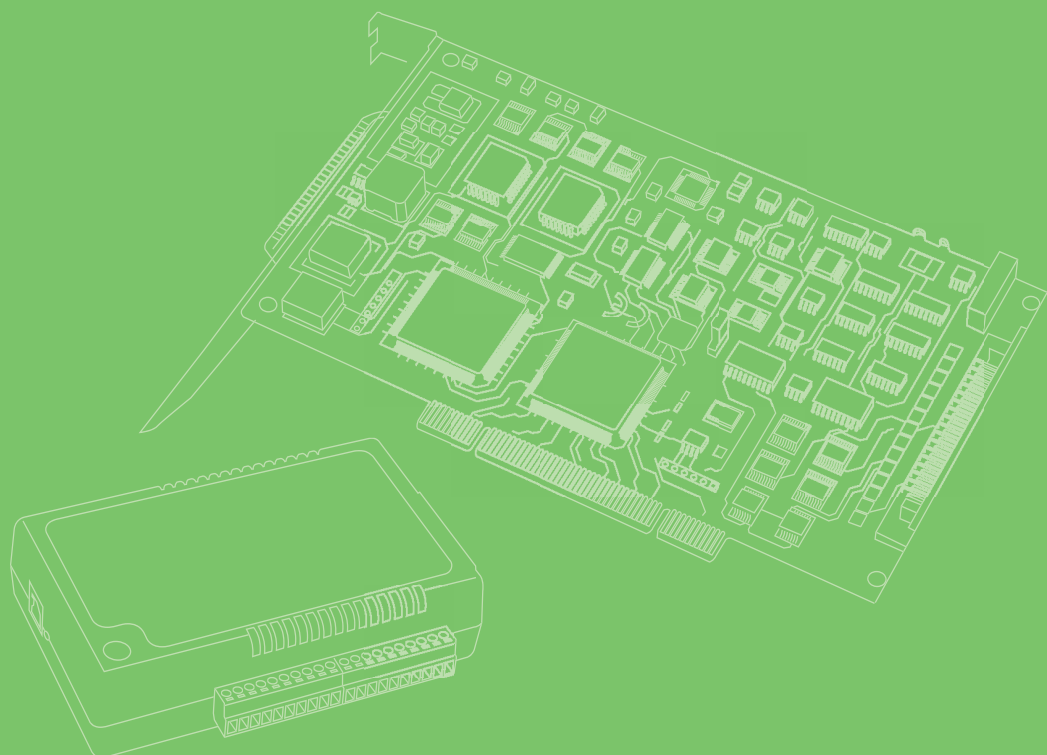

# PCL-733

32-channel Isolated Digital Input  
Card

**ADVANTECH**  
eAutomation

---

## Copyright

The documentation and the software included with this product are copyrighted 2008 by Advantech Co., Ltd. All rights are reserved. Advantech Co., Ltd. reserves the right to make improvements in the products described in this manual at any time without notice. No part of this manual may be reproduced, copied, translated or transmitted in any form or by any means without the prior written permission of Advantech Co., Ltd. Information provided in this manual is intended to be accurate and reliable. However, Advantech Co., Ltd. assumes no responsibility for its use, nor for any infringements of the rights of third parties, which may result from its use.

## Acknowledgements

Intel and Pentium are trademarks of Intel Corporation.

Microsoft Windows and MS-DOS are registered trademarks of Microsoft Corp.

All other product names or trademarks are properties of their respective owners.

## Product Warranty (2 years)

Advantech warrants to you, the original purchaser, that each of its products will be free from defects in materials and workmanship for two years from the date of purchase.

This warranty does not apply to any products which have been repaired or altered by persons other than repair personnel authorized by Advantech, or which have been subject to misuse, abuse, accident or improper installation. Advantech assumes no liability under the terms of this warranty as a consequence of such events.

Because of Advantech's high quality-control standards and rigorous testing, most of our customers never need to use our repair service. If an Advantech product is defective, it will be repaired or replaced at no charge during the warranty period. For out-of-warranty repairs, you will be billed according to the cost of replacement materials, service time and freight. Please consult your dealer for more details.

If you think you have a defective product, follow these steps:

1. Collect all the information about the problem encountered. (For example, CPU speed, Advantech products used, other hardware and software used, etc.) Note anything abnormal and list any onscreen messages you get when the problem occurs.
2. Call your dealer and describe the problem. Please have your manual, product, and any helpful information readily available.
3. If your product is diagnosed as defective, obtain an RMA (return merchandise authorization) number from your dealer. This allows us to process your return more quickly.
4. Carefully pack the defective product, a fully-completed Repair and Replacement Order Card and a photocopy proof of purchase date (such as your sales receipt) in a shippable container. A product returned without proof of the purchase date is not eligible for warranty service.
5. Write the RMA number visibly on the outside of the package and ship it prepaid to your dealer.

# Declaration of Conformity

## CE

This product has passed the CE test for environmental specifications when shielded cables are used for external wiring. We recommend the use of shielded cables. This kind of cable is available from Advantech. Please contact your local supplier for ordering information.

## CE

This product has passed the CE test for environmental specifications. Test conditions for passing included the equipment being operated within an industrial enclosure. In order to protect the product from being damaged by ESD (Electrostatic Discharge) and EMI leakage, we strongly recommend the use of CE-compliant industrial enclosure products.

## FCC Class B

Note: This equipment has been tested and found to comply with the limits for a Class B digital device, pursuant to part 15 of the FCC Rules. These limits are designed to provide reasonable protection against harmful interference in a residential installation. This equipment generates, uses and can radiate radio frequency energy and, if not installed and used in accordance with the instructions, may cause harmful interference to radio communications. However, there is no guarantee that interference will not occur in a particular installation. If this equipment does cause harmful interference to radio or television reception, which can be determined by turning the equipment off and on, the user is encouraged to try to correct the interference by one or more of the following measures:

- Reorient or relocate the receiving antenna.
- Increase the separation between the equipment and receiver.
- Connect the equipment into an outlet on a circuit different from that to which the receiver is connected.
- Consult the dealer or an experienced radio/TV technician for help.

# Technical Support and Assistance

1. Visit the Advantech web site at [www.advantech.com/support](http://www.advantech.com/support) where you can find the latest information about the product.
2. Contact your distributor, sales representative, or Advantech's customer service center for technical support if you need additional assistance. Please have the following information ready before you call:
  - Product name and serial number
  - Description of your peripheral attachments
  - Description of your software (operating system, version, application software, etc.)
  - A complete description of the problem
  - The exact wording of any error messages

---

## Warnings, Cautions and Notes

**Warning!** *Warnings indicate conditions, which if not observed, can cause personal injury!*



**Caution!** *Cautions are included to help you avoid damaging hardware or losing data. e.g.*



*There is a danger of a new battery exploding if it is incorrectly installed. Do not attempt to recharge, force open, or heat the battery. Replace the battery only with the same or equivalent type recommended by the manufacturer. Discard used batteries according to the manufacturer's instructions.*

## Document Feedback

To assist us in making improvements to this manual, we would welcome comments and constructive criticism. Please send all such - in writing to: [support@advantech.com](mailto:support@advantech.com)

## Safety Instructions

1. Read these safety instructions carefully.
2. Keep this User Manual for later reference.
3. Disconnect this equipment from any AC outlet before cleaning. Use a damp cloth. Do not use liquid or spray detergents for cleaning.
4. For plug-in equipment, the power outlet socket must be located near the equipment and must be easily accessible.
5. Keep this equipment away from humidity.
6. Put this equipment on a reliable surface during installation. Dropping it or letting it fall may cause damage.
7. The openings on the enclosure are for air convection. Protect the equipment from overheating. **DO NOT COVER THE OPENINGS.**
8. Make sure the voltage of the power source is correct before connecting the equipment to the power outlet.
9. Position the power cord so that people cannot step on it. Do not place anything over the power cord.
10. All cautions and warnings on the equipment should be noted.
11. If the equipment is not used for a long time, disconnect it from the power source to avoid damage by transient overvoltage.
12. Never pour any liquid into an opening. This may cause fire or electrical shock.
13. Never open the equipment. For safety reasons, the equipment should be opened only by qualified service personnel.
14. If one of the following situations arises, get the equipment checked by service personnel:
  15. The power cord or plug is damaged.
  16. Liquid has penetrated into the equipment.
  17. The equipment has been exposed to moisture.

18. The equipment does not work well, or you cannot get it to work according to the user's manual.
19. The equipment has been dropped and damaged.
20. The equipment has obvious signs of breakage.
21. DO NOT LEAVE THIS EQUIPMENT IN AN ENVIRONMENT WHERE THE STORAGE TEMPERATURE MAY GO BELOW -20° C (-4° F) OR ABOVE 60° C (140° F). THIS COULD DAMAGE THE EQUIPMENT. THE EQUIPMENT SHOULD BE IN A CONTROLLED ENVIRONMENT.
22. CAUTION: DANGER OF EXPLOSION IF BATTERY IS INCORRECTLY REPLACED. REPLACE ONLY WITH THE SAME OR EQUIVALENT TYPE RECOMMENDED BY THE MANUFACTURER, DISCARD USED BATTERIES ACCORDING TO THE MANUFACTURER'S INSTRUCTIONS.
23. The sound pressure level at the operator's position according to IEC 704-1:1982 is no more than 70 dB (A).

## Safety Precaution - Static Electricity

DISCLAIMER: This set of instructions is given according to IEC 704-1. Advantech disclaims all responsibility for the accuracy of any statements contained herein.

**Safety Precaution - Static Electricity**  
Follow these simple precautions to protect yourself from harm and the products from damage.

- To avoid electrical shock, always disconnect the power from your PC chassis before you work on it. Don't touch any components on the CPU card or other cards while the PC is on.
- Disconnect power before making any configuration changes. The sudden rush of power as you connect a jumper or install a card may damage sensitive electronic components.



# Contents

<b>Chapter 1</b>	<b>Overview .....</b>	<b>1</b>
1.1	Introduction .....	2
1.2	Features .....	2
1.3	Applications .....	2
1.4	Specifications .....	3
<b>Chapter 2</b>	<b>Hardware Installation .....</b>	<b>5</b>
2.1	Installation .....	6
2.2	Initial Inspection .....	6
2.3	Switch and Jumper Settings .....	7
	Table 2.1: Connectors, Jumpers, and Switches .....	7
2.4	Base Address selection (SW1) .....	8
	2.4.1 Interrupt level (JP1) .....	9
	2.4.2 Interrupt triggering (JP2, JP3) .....	9
2.5	Hardware Installation .....	10
<b>Chapter 3</b>	<b>Signal Connections .....</b>	<b>11</b>
3.1	Overview .....	12
3.2	Connector Pin Assignments .....	12
3.3	Isolated Input .....	13
<b>Appendix A</b>	<b>Register Format .....</b>	<b>15</b>
A.1	Register Format .....	16
	Table A.1: Register Assignment .....	16
<b>Appendix B</b>	<b>PC I/O Port Address Map .....</b>	<b>17</b>
B.1	PC I/O Port Address Map .....	18





# Chapter 1

Overview

---

## 1.1 Introduction

The PCL-733 has 32 isolated, bidirectional digital input channels, which provide 2,500 V<sub>DC</sub> of protection. The PCL-733 offers two PC interrupts with jumper-selectable IRQ. Each input channel corresponds to a bit in a PC I/O port, making the PCL-733 very easy to program.

## 1.2 Features

- 32 isolated, bidirectional digital input channels
- High-voltage isolation (2,500 V<sub>DC</sub>)
- Interrupt capacity
- D-type connectors for isolated input channels

## 1.3 Applications

- Industrial ON/OFF control
- Contact closure monitoring
- Switch status sensing
- BCD interfacing
- Digital I/O control
- Industrial and lab automation

## 1.4 Specifications

- Input voltage: 5 to 24 V<sub>DC</sub>
- Input resistance: 3 K $\Omega$  @ 0.2 W
- Isolation voltage: 2,500 V<sub>DC</sub>
- Throughput: 10 KHz max.
- Interrupt level: 2, 3, 5, 7, 10, 11, 12, 15
- Interrupt source: Isolated input channel 0 and channel 16
- Register format:
  - BASE+0 Isolated DI0-DI7
  - BASE+1 Isolated DI8-DI15
  - BASE+2 Isolated DI16-DI23
  - BASE+3 Isolated DI24-DI31
- Dimensions: 185 mm x 100 mm
- Connectors: DB-37 connector for isolated digital input
- Power consumption: +5 V: 320 mA typical, 500 mA maximum



# Chapter 2

Hardware Installation

---

## 2.1 Installation

This chapter gives users a package item checklist, proper instructions about unpacking and step-by-step procedures for both driver and card installation.

## 2.2 Initial Inspection

We carefully inspected the PCL-733 both mechanically and electrically before shipment. It should be free of marks and in perfect order on receipt.

As you unpack the PCL-733, check it for signs of shipping damage (damaged box, scratches, dents, etc.). If it is damaged or fails to meet specifications, notify our service department or your local sales representative immediately. Also, call the carrier immediately and retain the shipping carton and packing material for inspection by the carrier. We will then make arrangements to repair or replace the unit.

Discharge any static electricity on your body before you touch the board by touching the back of the system unit (grounded metal).

Remove the PCL-733 card from its protective packaging by grasping the rear metal panel. Handle the card only by its edges to avoid static electric discharge which could damage its integrated circuits. Keep the antistatic package. Whenever you remove the card from the PC, please store the card in this package for protection.

You should also avoid contact with materials that hold static electricity such as plastic, vinyl and styrofoam.

## 2.3 Switch and Jumper Settings

The PCL-733 has one function switch and three jumpers. The table below lists their functions. The following sections tell how to configure the card.

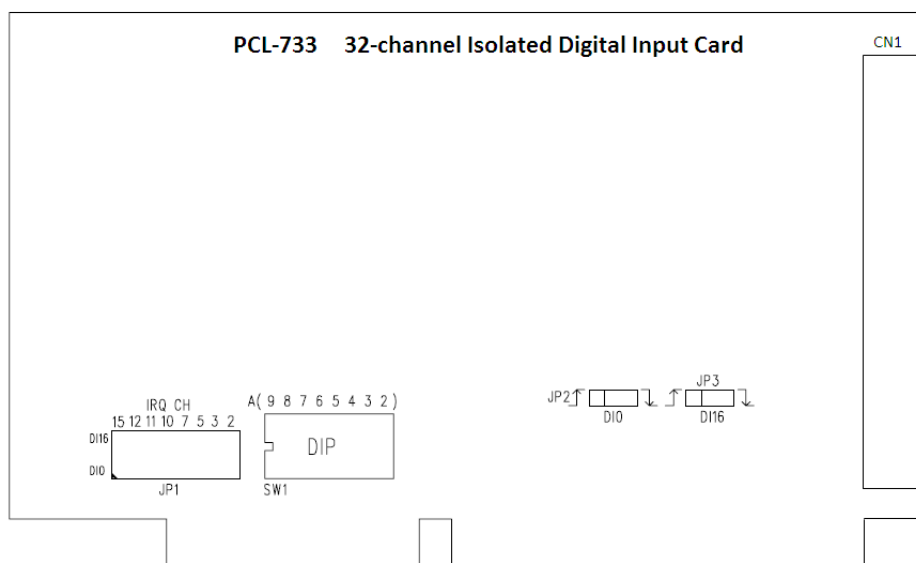

**Table 2.1: Connectors, Jumpers, and Switches**

Label	Function
CN1	Isolated output
JP1	Interrupt level
JP2	Interrupt trigger for DIO
JP3	Interrupt source for DI16
SW1	Card base address

## 2.4 Base Address selection (SW1)

You control the PCL-733's operation by reading or writing data to the PC's I/O (input/output) port addresses. The PCL-733 requires four consecutive address locations. Switch SW1 sets the card's base (beginning) address. Valid base addresses range from Hex 200 to Hex 3F0. Other devices in your system may, however, be using some of these addresses.

We set the PCL-733 for a base address of Hex 300 at the factory. If you need to adjust it to some other address range, set switch SW1 as shown in the following table:

Card I/O addresses (SW1)								
Range (hex)	Switch position							
	1	2	3	4	5	6	7	8
200 - 203	○	●	●	●	●	●	●	●
204 - 207	○	●	●	●	●	●	●	○
□								
* 300 - 303	○	○	●	●	●	●	●	●
□								
3F0 - 3F7	○	○	○	○	○	○	●	●

○ = Off      ● = On      \* = default

Note: Switches 1-8 control the PC bus address lines as shown below:

Switch	1	2	3	4	5	6	7	8
Line	A9	A8	A7	A6	A5	A4	A3	A2



### 2.4.1 Interrupt level (JP1)

Jumper JP1 selects the interrupt levels for channel 0 and channel 16.

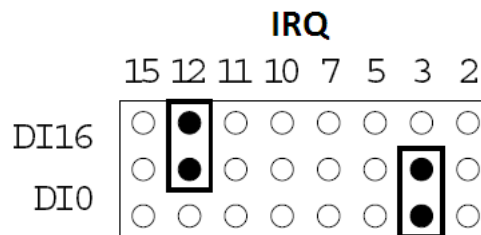

To disable one or both of the interrupts, simply remove the jumper clips, which you may store in the jumper so they don't get lost. See below:

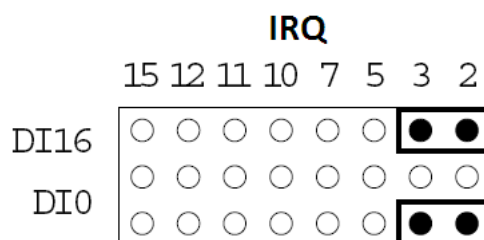

### 2.4.2 Interrupt triggering (JP2, JP3)

Jumpers JP2 and JP3 select the trigger edge (rising or falling) on which DI0 and DI16, respectively, will trigger an interrupt. Default jumper settings appear below

JP2: Rising Edge Interrupt Triggering on DI0

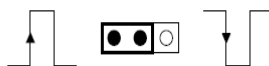

JP3: Falling Edge Interrupt Triggering on DI16

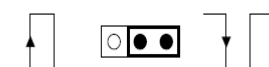

---

## 2.5 Hardware Installation

**Warning!** TURN OFF your PC power supply whenever you install or remove the PCL-733 or connect and disconnect cables.



1. Turn the computer off. Turn the power off to any peripheral devices such as printers and monitors.
2. Disconnect the power cord and any other cables from the back of the computer.
3. Remove the system unit cover (see the user's guide for your chassis if necessary).
4. Locate the expansion slots at the rear of the unit and choose any unused slot.
5. Remove the screw that secures the expansion slot cover to the system unit. Save the screw to secure the interface card retaining bracket.
6. Carefully grasp the upper edge of the PCL-733 card. Align the hole in the retaining bracket with the hole on top of the expansion slot and align the gold striped edge connector with the expansion slot socket. Press the board firmly into the socket.
7. Secure the PCL-733 using the screw you removed in step 5.
8. Attach any accessories to the PCL-733.
9. Replace the system unit cover. Connect the cables you removed in step 2. Turn the computer power on.

# Chapter 3

## Signal Connections

## 3.1 Overview

Maintaining signal connections is one of the most important factors in ensuring that your application system is sending and receiving data correctly. A good signal connection can avoid unnecessary and costly damage to your PC and other hardware devices. This chapter provides useful information about how to connect input and output signals to the PCL-733 via the I/O connector.

## 3.2 Connector Pin Assignments

The DB-37 connector is accessible from the card bracket.

### Abbreviations

IDI	Isolated Digital Input
EI . GND	External ground for isolated input
NC	No connection

IDI0	1	20	IDI1
IDI2	2	21	IDI3
IDI4	3	22	IDI5
IDI6	4	23	IDI7
EI . GND1	5	24	IDI8
IDI9	6	25	IDI10
IDI11	7	26	IDI12
IDI13	8	27	IDI14
IDI15	9	28	EI . GND2
IDI16	10	29	IDI17
IDI18	11	30	IDI19
IDI20	12	31	IDI21
IDI22	13	32	IDI23
EI . GND3	14	33	IDI24
IDI25	15	34	IDI26
IDI27	16	35	IDI28
IDI29	17	36	IDI30
IDI31	18	37	EI . GND4
NC	19		

### 3.3 Isolated Input

The PCL-733 has 32 isolated digital inputs, which accept 5-24V and have a resistance of 3 k $\Omega$ . Every 8 inputs share one external ground (EI.GND). The following figure shows how to connect an external input source to the card's isolated inputs:

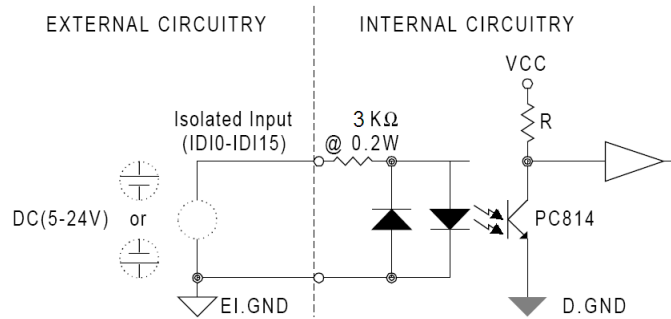



# Appendix **A**

## Register Format

## A.1 Register Format

Programming the PCL-733 is extremely simple. Each I/O channel corresponds to a bit in the card's registers. To read an input port, you simply read from the register.

The card requires four I/O register addresses. The address of each register is specified as an offset from the card's base address. For example, BASE+0 is the card's base address and BASE+2 is the base address + two bytes. If the card's base address is 300h, the register's address is 302h. See Chapter 2 for information on setting the card's base address. Writing any value to BASE+0 or BASE+2 will clear the interrupt flag of DI0 or DI16, respectively, enabling the next interrupt to be generated.

**Table A.1: Register Assignment**

<b>Address</b>	<b>Write</b>	<b>Read</b>
BASE + 0	Clear DI0 INT	IDI bits 0-7
BASE + 1	N/A	IDI bits 8-15
BASE + 2	Clear DI16 INT	IDI bits 16-23
BASE + 3	N/A	IDI bits 24-31



# Appendix **B**

## PC I/O Port Address Map

## B.1 PC I/O Port Address Map

Range (hex)	Function
000-1FF	Base System
200	Reserved
201	Came Control
202-277	Reserved
278-27F	Second Printer Port
280-2F7	Reserved
2F8-2FF	COM 2
300-377	Reserved
3713-37F	First Printer Port
380-3AF	Reserved
3B0-3BF	Mono Display/Print Adapter
3C0-3CF	Reserved
3D0-3DF	Color/Graphics
3E0-3EF	Reserved
3F0-3F7	Floppy Disk Drive
3F8-3FF	COM 1



# ADVANTECH

## *eAutomation*

[www.advantech.com](http://www.advantech.com)

Please verify specifications before quoting. This guide is intended for reference purposes only.

All product specifications are subject to change without notice.

No part of this publication may be reproduced in any form or by any means, electronic, photocopying, recording or otherwise, without prior written permission of the publisher.

All brand and product names are trademarks or registered trademarks of their respective companies.

© Advantech Co., Ltd. 2011