

WAFER-5825

**Low Power GX1-300 MMX
with SVGA/LCD, CardBus
Ethernet, & Audio SBC.
Ver 1.2**

Copyright Notice

©Copyright 2001 by ICP Electronics Inc. All Rights Reserved. Manual first edition May 1, 2001.

The information in this document is subject to change without prior notice in order to improve reliability, design and function and does not represent a commitment on the part of the manufacturer.

In no event will the manufacturer be liable for direct, indirect, special, incidental, or consequential damages arising out of the use or inability to use the product or documentation, even if advised of the possibility of such damages.

This document contains proprietary information protected by copyright. All rights are reserved. No part of this manual may be reproduced by any mechanical, electronic, or other means in any form without prior written permission of the manufacturer.

Trademarks

WAFER-5825 is a registered trademark of ICP Electronics Inc. IBM PC is a registered trademark of International Business Machines Corporation. Intel is a registered trademark of Intel Corporation. Other product names mentioned herein are used for identification purposes only and may be trademarks and/or registered trademarks of their respective companies

Contents

Introduction	4
1.1 Specifications.....	4
1.2 What You Have.....	6
Installation	7
2.1 Wafer-5825 Block Diagram & Board Layout.....	7
2.2 Unpacking Precautions.....	9
2.3 System Memory DRAM	9
2.4 Watch-Dog Timer Setting.....	9
2.5 Clear CMOS Setup.....	10
2.6 LCD Vcc Voltage Selector.....	10
Connection	11
3.1 PCI E-IDE Disk Drive Connector (CN2)	11
3.2 Parallel Port (CN11).....	13
3.3 Serial Ports (CN14, CN12).....	13
3.4 Audio Connector	14
3.5 Keyboard & PS/2 Mouse Connector (CN16).....	15
3.6 USB Port Connector (CN17).....	15
3.7 IrDA Infrared Interface Port (CN5).....	16
3.8 VGA Connector (CN13)	16
3.9 LCD Interface Connector	16
3.10 LAN RJ45 Connector	18
3.11 External Power Connector	18
3.12 Power and HDD LEDS.....	19
3.13 Reset Button.....	19
3.14 Debug Port	19
3.15 CardBus Connector	19
3.16 Buzzer Connector	20

AWARD BIOS Setup	21
4.1 GETTING START.....	21
4.2 STANDARD CMOS SETUP.....	22
4.3 BIOS FEATURES SETUP.....	24
4.4 CHIPSET FEATURES SETUP.....	25
4.5 POWER MANAGEMENT SETUP.....	26
4.6 PNP / PCI CONFIGURATION.....	27
4.7 LOAD BIOS DEFAULTS.....	28
4.8 LOAD SETUP DEFAULTS.....	29
4.9 INTEGRATED PERIPHERALS.....	30
4.10 SUPERVISOR PASSWORD AND USER PASSWORD.....	32
4.11 IDE HDD AUTODETECTION.....	33
4.12 SAVE & EXIT SETUP.....	34
4.13 EXIT WITHOUT SAVING.....	35
SVGA Setup	36
5.1 Introduction.....	36
5.2 Further Information.....	37
Audio	38
6.1 Introduction.....	38
PCI Bus Ethernet Interface	39
7.1 Introduction.....	39
CardBus Interface	40
8.1 Introduction.....	40
8.2 Support.....	41
8.3 Software Support.....	41
Appendix A. Watch-Dog Timer	42
Appendix B. I/O Address Map	45

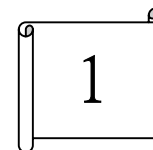

Introduction

WAFER-5825 is designed for limited space applications with only the size of a 3½" hard drive. It supports the full functions of an AT-compatible industrial computer on a single board. The WAFER-5825 is equipped with a low-power consumption and high performance GX1-300 processor on board. It also contains an SDRAM SODIMM socket that can support up to 512MB memory.

The WAFER-5825 provides an Ethernet interface, audio interface, EIDE interface, one CardBus interface, one parallel port, two serial RS-232 ports, two USB ports, and a mini-DIN PS/2 keyboard/mouse interface. The built-in SVGA/LCD display controller supports both the CRT and LCD display simultaneously. It offers the resolutions of LCD screen up to 800 x 600 and CRT resolutions up to 1280 x 1024 @ 16 colors. The display type is configured by software utility. The Flash ROM contains both the system BIOS and the VGA BIOS. The modification, in case of necessary, could be done by reprogramming the Flash ROM.

1.1 Specifications

***NS GX1-300 MMX 32-Bit x86 Processor**

- Supports Intel MMX instruction set extension for the acceleration of multi media applications
- 16 KB unified L1 cache
- Five-stage pipelined integer unit
- Integrated Floating Point Unit (FPU)

***System memory:** One 144-pin SODIMM socket support up to 512 MB SDRAM

***BIOS:** AWARD 256 KB Flash memory

***Display Controller**

MediaGx processor has applied the UMA technology that

provides 1-4MB display memory, to be set up by BIOS
Supports CRT and TFT LCD displays simultaneously
Supports 18-bit TFT LCD panel resolution up to 1024x768 @ 18bpp
Supports non-interlaced CRT monitor's resolutions up to [1280x1024 @ 256](#) colors or 1024x768 @ 16bpp

***Audio**

Compliant to AC97, support stereo
Connector: Speaker, Mic-in, Line-in, Line-out, CD-ROM in

***IDE interface:** The IDE support to two PCI Enhanced IDE hard drives

***CardBus interface:** one PC Card 95/97 compliant sockets interface supports the 32-bit CardBus (Card-32) and 16-bit CardBus (Card-16) without external buffers. Also, support ZV (Zoom Video) Card control interface without external buffers

***Serial ports:** two RS232 ports

***Parallel port:** One Parallel port, supports SPP/EPP/ECP mode, IEEE 1284 compatible.

***PS/2 Mouse/Keyboard connector:** A6-pin mini DIN connector is located on the mounting bracket for easy connection to a keyboard or PS/2 mouse

***USB interface:** two USB ports, USB 1.0 compliant

***Power management:** supports power saving modes including Normal/Doze/Sleep modes. APM1.1 compliant

***WatchDog timer:** can be set to 1-255 second's period. Reset was generated when CPU did not periodically trigger the timer.

***10/100Mbps Ethernet Controller:** Realtek RTL8139 IEEE802.u 100 BASE-TX standard Dual Auto-sensing interface to 10MBps or 100MBps networks. On board RJ45 connector provides easy connection.

***Power supply:** +12V (11.75V to 12.25V) @0.7A (typical)

***Operating temperature:** -20-60°C (-4-140°F)

***Dimension:** 5.9" (L) x4.2" (W) (145mmx102mm)

1.2 What You Have

Before you begin installing the product, please check if the following materials are included in the package:

- 1 Wafer-5825 All-in-one single board computer
- 1 CD disk for utility and drivers
- 1 2.5" IDE flat cable (44-pin 2.0mm pitch to 44-pin 2.0mm pitch)
- 1 one to two 6pin mini Din connector for keyboard and mouse
- 1 serial port cable
- 1 standard D25 connector for parallel cable
- 1 audio cable
- 1 Power cable
- 1 Buzzer cable

If any of these items are missing or damaged, contact your distributor or sales representative immediately.

2

Installation

This chapter gives instructions about how to set up the WAFER-5825 hardware, including directions of setting jumpers and connecting peripherals, switches and indicators. Before installation, please pay attention to the unpacking precautions on the following page for safety.

2.1 Wafer-5825 Block Diagram & Board Layout

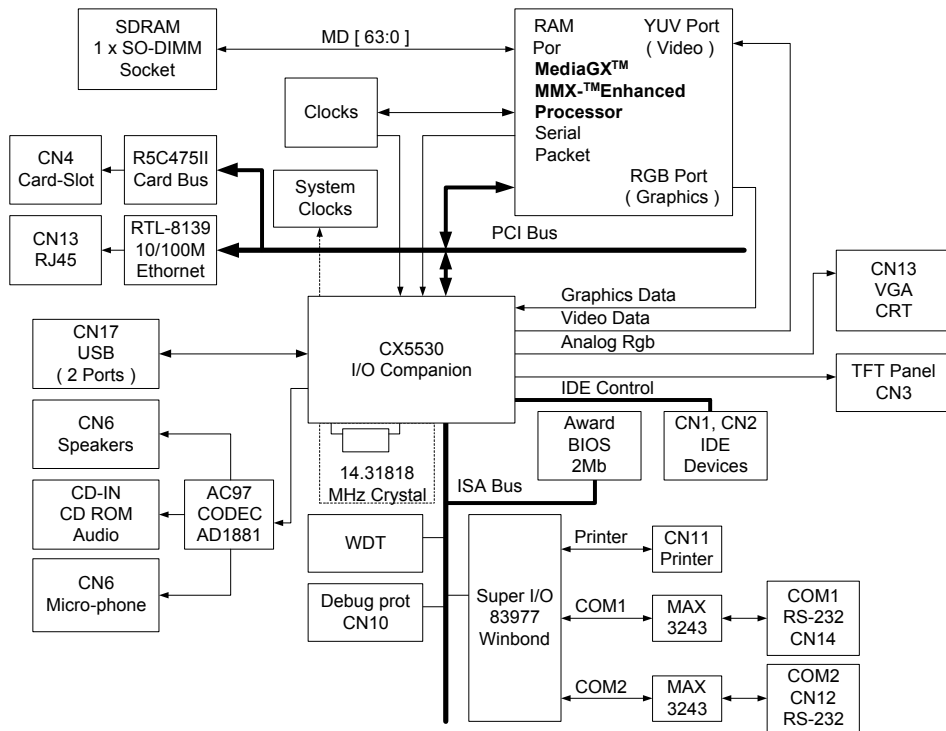

Wafer-5825 Block diagram

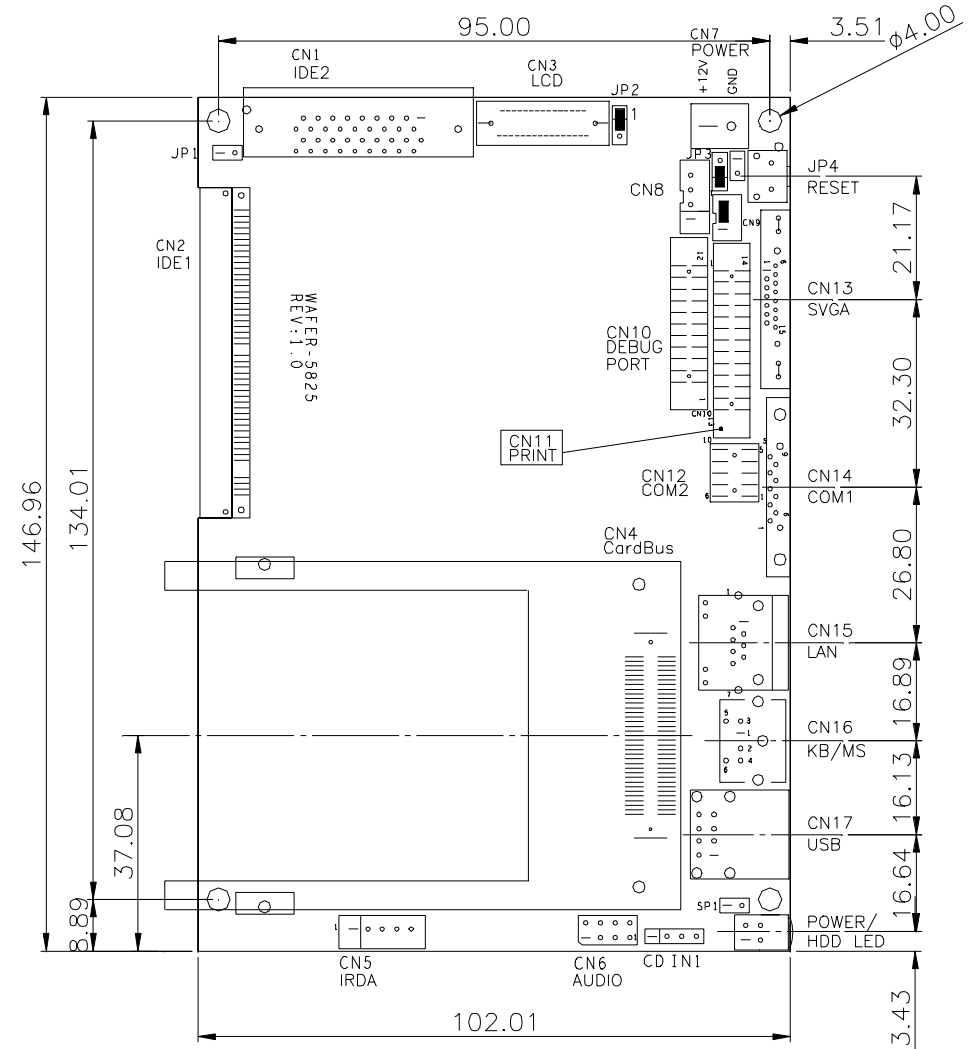

Wafer-5825 Board Layout

2.2 Unpacking Precautions

Some components of WAFER-5825 SBC are very sensitive to static electric charges and can be damaged by a sudden rush of power. To protect it from unintended damage, be sure to note these precautions:

Ground yourself to remove any static charge before touching the Wafer-5825 SBC. You can do it by using a grounded wrist strap at all times or by frequently touching any conducting materials that is connected to the ground.

Handle your Wafer-5825 SBC by its edges. Don't touch IC chips, leads or circuitry if not necessary.

Do not plug any connector or jumper while the power is on.

2.3 System Memory DRAM

There is one 144-pin SO-DIMM socket to accept 3.3V non-buffered SDRAM. The max Memory size is 512MB.

2.4 Watch-Dog Timer Setting

The Watch-Dog Timer is enabled by reading port 543H. It should be triggered before the time-out period ends, otherwise it will assume the program operation is abnormal and will issue a reset signal to restart. The Watch-Dog Timer is disabled by reading port 143/943H. For Detail information on Watch-Dog Timer, Refer to Appendix A

- JP1: Watch-Dog Active Type Setting

JP1	DESCRIPTION
SHORT	RESET WHEN WDT TIME-OUT
OPEN	DISABLE WDT

2.5 Clear CMOS Setup

If you have to clear the CMOS Setup (for example, if you forgot the password, you should clear the CMOS and then set the password again.), you should close the JP3 (Pin2 and Pin3) about 3 seconds, then open it again. Opening JP3 can set the CMOS back to normal operation mode,

- JP3 Clear CMOS Setup (Reserved Function)

JP3	DESCRIPTION
1-2	Normal Operation
2-3	Clear CMOS Setup

2.6 LCD Vcc Voltage Selector

The LCD interface connector CN15 can provide 5V or 3.3V power supply by selecting the JP2 to meet the different LCD requirement.

JP2	DESCRIPTION
1-2	5V
2-3	3.3V

3

Connection

This chapter describes how to connect peripherals, switches and indicators to the WAFER-5825 board.

3.1 PCI E-IDE Disk Drive Connector (CN2)

For IDE HDD connection, The Wafer-5825 was designed with one 2.0mm connector (CN2), which could be converted to two 2.54mm standard IDE connector via proprietary cable. Using this cable you can attach two IDE hard disk drives to the WAFER-5825.

CN2: 44-pin Primary Mini-pitched IDE Interface Connector

- CN2: Primary IDE Interface Connector

PIN NO.	DESCRIPTION	PIN NO.	DESCRIPTION
1	RESET#	2	GROUND
3	DATA 7	4	DATA 8
5	DATA 6	6	DATA 9
7	DATA 5	8	DATA 10
9	DATA 4	10	DATA 11
11	DATA 3	12	DATA 12
13	DATA 2	14	DATA 13
15	DATA 1	16	DATA 14
17	DATA 0	18	DATA 15
19	GROUND	20	N/C
21	IDE DRQ	22	GROUND
23	IOW#	24	GROUND
25	IOR#	26	GROUND
27	IDE CHRDY	28	GROUND

29	IDE DACK	30	GROUND-DEFAULT
31	INTERRUPT	32	N/C
33	SA1	34	N/C
35	SA0	36	SA2
37	HDC CS0#	38	HDC CS1#
39	HDD ACTIVE#	40	GROUND
41	VCC	42	GROUND
43	GROUND	44	GROUND

- CN1: Secondly IDE Interface Connector

PIN NO.	DESCRIPTION	PIN NO.	DESCRIPTION
1	RESET#	19	GROUND
2	GROUND	20	N/C
3	DATA 7	21	IDE DRQ
4	DATA 8	22	GROUND
5	DATA 6	23	IOW#
6	DATA 9	24	HDC CS0#
7	DATA 5	25	IOR#
8	DATA 10	26	GROUND
9	DATA 4	27	IDE CHRDY
10	DATA 11	28	HDC CS1#
11	DATA 3	29	IDE DACK
12	DATA 12	30	GROUND
13	DATA 2	31	INTERRUPT
14	DATA 13	32	N/C
15	DATA 1	33	SA1
16	DATA 14	34	GROUND
17	DATA 0	35	SA0
18	DATA 15	36	SA2

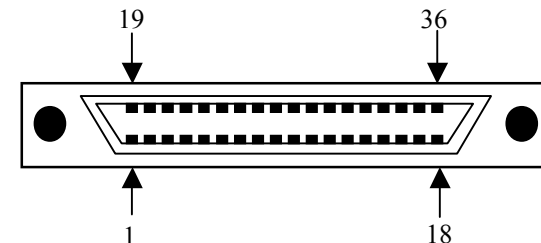

3.2 Parallel Port (CN11)

This port is usually connected to a printer. The WAFER-5825 includes an on-board parallel port (CN11), accessed through a 26-pin flat-cable connector.

- CN11: Parallel Port Connector

PIN NO.	DESCRIPTION	PIN NO.	DESCRIPTION
1	STROBE#	2	DATA 0
3	DATA 1	4	DATA 2
5	DATA 3	6	DATA 4
7	DATA 5	8	DATA 6
9	DATA 7	10	ACKNOWLEDGE
11	BUSY	12	PAPER EMPTY
13	PRINTER SELECT	14	AUTO FORM FEED #
15	ERROR#	16	INITIALIZE
17	PRINTER SELECT LN#	18	GROUND
19	GROUND	20	GROUND
21	GROUND	22	GROUND
23	GROUND	24	GROUND
25	GROUND	26	N/C

3.3 Serial Ports (CN14, CN12)

The Wafer-5825 offers two high speeds NS16C550 compatible UARTS with Read/Receive 16 byte FIFO. These ports let you connect to serial devices or a communication network. One 9-pin D-SUB connector and one 10-pin header are provided by the WAFER-5825. The detailed pin assignment of the connectors are specified as following tables:

- CN14: Serial Port1 Connector (9-pin DSUB)

PIN NO.	DESCRIPTION
1	DATA CARRIER DETECT (DCD)
2	RECEIVE DATA (RXD)
3	TRANSMIT DATA (TXD)
4	DATA TERMINAL READY (DTR)
5	GROUND (GND)
6	DATA SET READY (DSR)
7	REQUEST TO SEND (RTS)
8	CLEAR TO SEND (CTS)
9	RING INDICATOR (RI)

- CN12: Serial Port2 Connector (10-pin 2.0mm Header)

PIN NO.	DESCRIPTION	PIN NO.	DESCRIPTION
1	DCD	2	DSR
3	RX	4	RTS
5	TX	6	CTS
7	DTR	8	RI
9	GND	10	N/C

3.4 Audio Connector

The audio function was organized by CX5530 I/O companions and AC97 CODEC. You can use CD-IN as the input port (e.g.: connected to the output of CD player), depending on the type of connector that you have.

- CD-IN: CD_AUDIO INPUT Connector

PIN NO.	DESCRIPTION
1	JCD_R
2	GND
3	GND
4	JCD_L

- CN6: Audio Connector

This is the output port of your Sound System. Pin 1-3 can be connected to earphone or loudspeaker. Pin 5-6 can be used as input port if it is connected to the earphone jack of your CD. Pin 7-8 is for microphone.

PIN NO.	DESCRIPTION	PIN NO.	DESCRIPTION
1	LINE OUT L	2	GND
3	LINE OUT R	4	GND
5	LINE IN R	6	LINE IN L
7	MIC	8	GND

3.5 Keyboard & PS/2 Mouse Connector (CN16)

A 6-pin mini DIN connector (CN16) is located on the mounting bracket for easy connection to a keyboard or PS/2 mouse. The card comes with a cable to convert the 6-pin mini-DIN connector to two 6-pin mini-DIN connector for keyboard and mouse connection

- CN16: 6-pin Mini-DIN Keyboard & Mouse Connector

PIN NO.	DESCRIPTION
1	KEYBOARD DATA
2	MOUSE DATA
3	GROUND
4	+5V
5	KEYBOARD CLOCK
6	MOUSE CLOCK

3.6 USB Port Connector (CN17)

The WAFER-5825 provides two USB interfaces, which gives the complete plug and play, for up to 127 external devices.

- CN17: Internal USB Connector

1.	USBVCC1	2.	D1-
3.	D1+	4.	GND

5.	USBVCC2	6.	D2-
7.	D2+	8.	GND
9.	GND	10.	GND

3.7 IrDA Infrared Interface Port (CN5)

The WAFER-5825's built-in an IrDA port which supports Serial Infrared (SIR) or Amplitude Shift Keyed IR (ASKIR) interface. Using the IrDA port have to set SIR or ASKIR model in the BIOS's Peripheral Setup's COM2. Then the normal RS-232 COM2 will be disabled.

- CN5: IrDA connector

PIN NO.	DESCRIPTION
1	VCC
2	NC
3	IRRX
4	Ground
5	IR-TX

3.8 VGA Connector (CN13)

The WAFER-5825's built-in 15-pin VGA connector accepts the CRT monitor.

- CN13: 15-pin Female Connector

1	RED	2	GREEN
3	BLUE	4	NC
5	GROUND	6	GROUND
7	GROUND	8	GROUND
9	NC	10	GROUND
11	NC	12	DDC DAT
13	HSYNC	14	VSYNC
15	DDCCLK		

3.9 LCD Interface Connector

The WAFER-5825 provides a 31-pin connector for the LCD flat panel interface .The Wafer-5825 comes to support TFT

LCD panels at following display options: (This is a reference table only, may support more panels)

Video Display type	Resolution	Example
TFT VGA	640X480 , 64K Color , 18bits	Toshiba LTM10C209A
TFT SVGA	800X600 , 64K Color , 18bits	Toshiba LTM12C275A
TFT XVGA	1024X768 , 64K Color , 18bits	LG LM151X1

The display options need to be setup manually from BIOS. The BIOS **“Integrated Peripheral”** Setup will allow you to choose display resolution either 640X480 or 800X600, 1024X768.

- CN3: LCD Interface Connector – only supports up to 18 bit LCD. For better display quality, the length of LCD cable should be shorter than 35 cm.

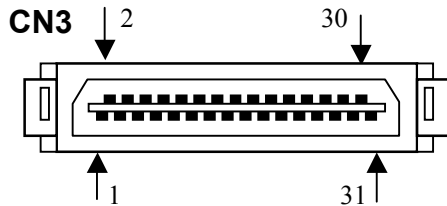

PIN NO.	FUNCTION	PIN NO.	FUNCTION
1	GND	2	SHFCLK
3	LP	4	FLM
5	GND	6	RED0
7	RED1	8	RED2
9	RED3	10	RED4
11	RED5	12	GND
13	GREEN0	14	GREEN1
15	GREEN2	16	GREEN3
17	GREEN4	18	GREEN5
19	GND	20	BLUE0
21	BLUE1	22	BLUE2
23	BLUE3	24	BLUE4
25	BLUE5	26	GND
27	M	* 28	PLCD

29	PLCD	30	PLCD
31	NC		

<Note> Pin 28,29,30 “PLCD”, the voltage of LCD can be selected 5V or 3.3V by the jumper JP2.

- CN8: LCD Inverter Connector

PIN NO.	DESCRIPTION
1	+12V
2	ENABKL
3	GND
4	GND

3.10 LAN RJ45 Connector

The WAFER-5825’s built-in RJ45 LAN connector is for 10/100Mbps Ethernet (RTL8139C).

- CN15: LAN RJ45 Connector

PIN NO.	DESCRIPTION	PIN NO.	DESCRIPTION
1	TX+	5	NC
2	TX-	6	RX-
3	RX+	7	NC
4	NC	8	NC

- Ethernet LED setup

LED	ACTIVE INDICATION
Green lamp	RX
Orange lamp	TX

3.11 External Power Connector

The WAFER-5825 has an on-board external power connector CN7. You can connect power directly to the CPU board.

- CN7: External Power Connector

PIN NO.	DESCRIPTION
1	+12V
2	GROUND

3.12 Power and HDD LEDS

- D2: Power / HDD setup

LED	ACTIVE INDICATION
Green lamp	Power
Orange lamp	HDD

3.13 Reset Button

- JP4: Reset Button

PIN NO.	DESCRIPTION
1	RESET
2	GND

3.14 Debug Port

This port is used for debugging only (I/O Port 80H)

- CN10: Debug Card Connector

PIN NO.	Description	PIN NO.	Description
1	SD0	2	+5V
3	SD1	4	SA0
5	SD2	6	SA1
7	SD3	8	SA2
9	SD4	10	SA3
11	SD5	12	SA4
13	SD6	14	SA5
15	SD7	16	SA6
17	NC	18	SA7
19	RSTDRV	20	IOW#
21	GND	22	AEN

3.15 CardBus Connector

The WAFER-5825 built-in a CardBus interface connector (CN4)

- CN4: CardBus Connector

PIN NO.	FUNCTION	PIN NO.	FUNCTION
1	GND	2	D3
3	D4	4	D5
5	D6	6	D7
7	CE1#	8	A10
9	OE#	10	A11
11	A9	12	A8
13	A13	14	A14
15	WE#	16	READY
17	VCC	18	VCC
19	A16	20	A15
21	A12	22	A7
23	A6	24	A5
25	A4	26	A3
27	A2	28	A1
29	A0	30	D0
31	D1	32	D2
33	WP	34	GND
35	GND	36	CD1#
37	D11	38	D12
39	D13	40	D14
41	D15	42	CE2#
43	VS1#	44	IORD#
45	IOWR#	46	A17
47	A18	48	A19
49	A20	50	A21
51	VCC	52	VCC
53	A22	54	A23
55	A24	56	A25
57	VS2#	58	RESET
59	WAIT#	60	INPACK#
61	REG#	62	BVD2
63	BVD1	64	D8
65	D9	66	D10
67	CD2#	68	GND
69	GND	70	GND

3.16 Buzzer Connector

- SP1: Buzzer Connector

PIN NO.	DESCRIPTION
1	PCBEEP
2	GND

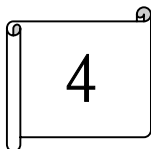

AWARD BIOS Setup

WAFER-5825 uses the AWARD PCI/ISA BIOS for system configuration. The AWARD BIOS setup program is designed to provide maximum flexibility in configuring the system by offering various options that may be selected to meet end-user requirements. This chapter is written to assist you in the proper usage of these features.

4.1 GETTING START

When you turn on the power button, the BIOS will enter the Power-On-Self-Test routines. These routines will be executed for system test and initialization and system configuration verification. After the POST routines are completed, the following message appears:

" Hit DEL if you want to run SETUP"

```

ROM PCI/ISA BIOS (2A43419E)
CMOS SETUP UTILITY
AWARD SOFTWARE, INC.

```

STANDARD CMOS SETUP	INTEGRATED PERIPHERALS
BIOS FEATURES SETUP	SUPERVISOR PASSWORD
CHIPSET FEATURES SETUP	USER PASSWORD
POWER MANAGEMENT SETUP	IDE HDD AUTO DETECTION
PNP/PCI CONFIGURATION	SAVE & EXIT SETUP
LOAD BIOS DEFAULTS	EXIT WITHOUT SAVING
LOAD SETUP DEFAULTS	

```

Esc : Quit
F10 : Save & Exit Setup
F1 : ← : Select Item
(Shift)F2 : Change Color

```

To access AWARD BIOS SETUP UTILITY, press key. The following screen will be displayed at this time:

4.2 STANDARD CMOS SETUP

The Standard CMOS Setup is used for basic hardware system configuration. The main function is for Date/Time setting and Floppy/Hard Disk Drive setting. Please refer the following screen for this setup.

```

ROM BIOS SETUP UTILITY (AWARD)
PROGRAM : CMOS SETUP
AWARD SOFTWARE, INC.

```

FIELD	DATE	TIME	DISK	MEMO	FIXED	MOUSE	KEYBOARD	MODE
Standard CMOS Setup	01/01/98	12:00	1	32MB	1	1	1	Auto
Advanced CMOS Setup	01/01/98	12:00	1	32MB	1	1	1	Auto
Chipset Features Setup	01/01/98	12:00	1	32MB	1	1	1	Auto
Power Management Setup	01/01/98	12:00	1	32MB	1	1	1	Auto

```

Date : 01/01/98
Time : 12:00
Disk : 1
Memo : 32MB
Fixed : 1
Mouse : 1
Keyboard : 1
Mode : Auto

```

```

Esc : Quit
F10 : Save & Exit Setup
F1 : ← : Select Item
(Shift)F2 : Change Color

```

To set the Date, for example, press either the arrow or <Enter> button on your keyboard to select one of the fields (Month, Date or Year) then press either <PgUp> or <PgDn> to increase or decrease the value of that field. Do the same steps for Time setting.

For IDE hard disk drive setup, please check the following possible setup procedure:

1. Use the Auto setting for detection during boot-up.

- **Audio Low DMA Select -- DMA0, DMA1, DMA3, Disabled**
To select the high DMA channel.
- **Audio High DMA Select -- DMA5, DMA6, DMA7, Disabled**
To select the high DMA channel.
- **Multiple Monitor Support -- No Onboard, PCI first, M/B first**
To select the primary VGA for multiple monitor support in WINDOWS.
- **Video Memory Size -- 1.5M, 2.5M, 4.0M**
To select the size of Video memory. It makes use of system memory for display.

4.10 SUPERVISOR PASSWORD AND USER PASSWORD

Supervisor Password sets a password that is used to protect your system and Setup Utility. Supervisor Password has higher priority than User Password. Once you setup the password, the system will always ask you to key-in password every time you enter the BIOS SETUP. If you enter the BIOS SETUP with Supervisor Password, you can choose every setup/option on the main menu but with User Password, you can only choose three setup/options (USER PASSWORD, SAVE & EXIT SETUP and EXIT WITHOUT SAVING). To disable these passwords, enter the BIOS SETUP room with Supervisor Password and then just press the <Enter> key instead of entering a new password when the 'Enter Password' prompts pop-up.

N.B. : if you forget the password, do the Clear/Reset CMOS procedure (see Section 2.5 Clear CMOS Setup)

4.13 EXIT WITHOUT SAVING

Select this option if you want to exit the Setup without saving the changes that you made. Just simply press <Enter> key and you will exit the BIOS SETUP without saving the

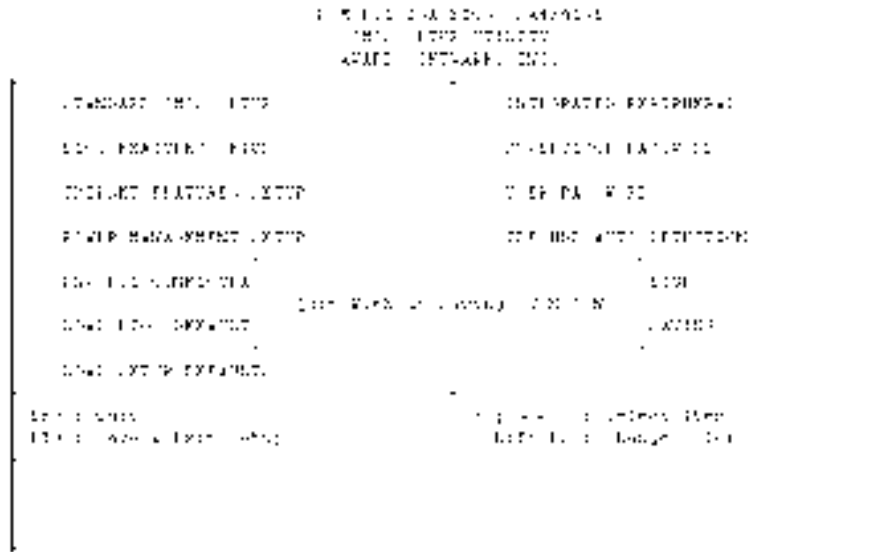

changes.

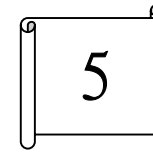

SVGA Setup

5.1 Introduction

The WAFER-5825 is equipped with on-board LCD/VGA interface. The description below is its specifications and features:

5.1.1 Chipset

The WAFER-5825 uses a Cyrix CX5530 chipset as its SVGA controller. It is compatible with many common 18-bit LCD displays and traditional analog CRT monitors. The VGA BIOS supports LCD. Besides, it also accepts interlaced and non-interlaced analog monitors (color and monochrome VGA) with high-resolution quality while maintaining complete IBM VGA compatibility. But digital monitors (i.e. MDA, CGA, and EGA) can be NOT supported. Multiple frequency (multi-sync) monitors are operated as if they were analog monitors.

5.1.2 Display memory

Having 1.5 ~ 4 MB UMA memory, the VGA controller can make CRT displays or color panel displays perform with resolutions up to 1024 x 768 at 64 K colors. The display memory can be modified up to 4 MB in BIOS for true-color resolution of 1024 x 768.

5.1.3 Display drivers

1. Win95,98 drivers(VGA & Audio) in driver CDROM
Vga \ MediaGX \ Win9X \ National Geode Win9x
Drivers1.2.exe

2. WinNT4.0 drivers in driver CDROM
Vga \ MediaGX \ Nt40 \

5.2 Further Information

For more detailed information about the PCI/SVGA installation in your WAFER-5825, including driver updates, troubleshooting instructions, please refer to the following webs which provide some resources you may need. If not find the information you need, please contact with your local contributor or ICP support team:

ICP web site: www.iei.com.tw

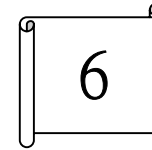

Audio

6.1 Introduction

With on-board audio interface, the WAFER-5825 can perform high-quality stereo sound and FM music synthesis (ESFM) by using the CX5530 audio controller. The audio interface has functions of recording, compressing, and playing back voice, sound, and music with a built-in mixer control. In addition, the on board audio interface supports the Plug and Play (PnP) standard and provides PnP configuration for audio, FM, and MPU-104 logical devices. It is compatible with AC97 version 2.0, voice, and music functions. The ESFM synthesizer is register compatible with the OPL3 and has extended capabilities.

6.1.1 Audio drivers

1. Installing software driver in Windows NT

The driver was provided from the CD utility.
WinNT4.0 Audio drivers in Driver CDROM
Audio \ MediaGX \ Nt40 \

2. Installing software driver in Win95/98

The audio drivers will be installed automatically while you install the display driver.

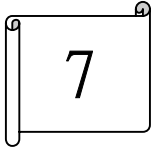

PCI Bus Ethernet Interface

7.1 Introduction

The WAFER-5825 provides a high performance 32-bit Ethernet chipset which is completely compliant with IEEE 802.3 100 Mbps CSMA/CD standards. It is both 100Base-T and 10Base-T compatible. The major network operating system fits it. The medium type can be set up via the RSET8139.exe program included on the utility CD.

The Ethernet port supplies a standard RJ-45 connector on board. To utilize the network boot feature is by incorporating the boot ROM image files for the appropriate network operating system. The boot ROM BIOS files are combined with system BIOS, which can be enabled/disabled in the BIOS setup.

The 8139x utility tools all in driver CDROM

Lan \ Realtek \ 8139c \

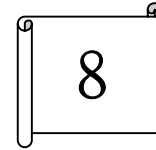

CardBus Interface

8.1 Introduction

The WAFER-5825 provides a high performance 32-bit PCI bus Interface to CardBus interface chipset, which can support the 32-bit CardBus (Card-32), and the 16-bit CardBus (Card-16). It also supports ZV (Zoom Video) Card control interface without external buffers.

8.1.1 Chipset

The R5C475II is a PC card control offering a single chip solution as a bridge between PCI bus and CardBus. Concerning the card control interface, the R5C475II's register set is compatible with the Intel 82365SL and Ricoh's RF5C396/366 in order to maintain backward compatibility with a existing 16-bit PC Card compliant with PCMCIA2.1/JEIDA4.2 so that the existing PC card are available.

8.2 Support

In the CardBus standard adopted by PC Card 95, the data transfer bus was extended to 32bit and bus clock became 33MHz. Since the busmaster mode is also implemented, CardBus is suitable for high performance required multimedia cards such as fast LAN Card, VIDEO Card or graphic processing cards. With the ZV Card such as MPEG cards, Multimedia environment will be easily realized.

16-bit PC Card control interface signals, controlled by the timing synthesizer circuit, are programmable so that not only timing requirement of 16-bit PC Card compliant with PCMCIA2.1/ JEIDA4.2 but also faster timing requirement than it is available.

Recognition of CardBus or 16-bit PC Card is examined automatically when cards are inserted, and the card control interface will be composed properly on the result of recognition. So, CardBus card and 16-bit PC Card are available simultaneously

8.3 Software Support

8.3.1 OS Support

[Windows 98]

R5C475II is fully supported by Windows 98.

8.3.2 R5C475II Installation

[Windows 98]

No configuration is necessary except the general setting of BIOS. (4.3)

Appendix A. Watch-Dog Timer

The WatchDog Timer is a device to ensure that standalone systems can always recover from catastrophic conditions that cause the CPU to crash. This condition may have occurred by external EMI or a software bug. When the CPU stops working normally, hardware on the board will perform hardware reset (cold boot) to bring the system back to a known state.

Three I/O ports control the WatchDog Timer.

543	Write	Set Watch-Dog Time period
543 (hex)	Read	Enable the refresh the WatchDog Timer.
143/943 (hex)	Read	Disable the WatchDog Timer.

Prior to enable the WatchDog Timer, user has to define Timer first. The output data is a value of time interval and the range of the value is from 01(hex) to FF (hex) and time interval 1 sec to 255 sec.

Data	Time Interval
01	1 sec
02	2 sec
03	3 sec
04	4 sec
.	.
.	.
.	.
FF	255 sec

This will enable and activate the countdown timer which will eventually time out and reset the CPU to ensure that this reset condition does not occur, the Watch-Dog Timer must be periodically refreshed by reading the same I/O port 143/943H and

543H. This must be done within the time out period that is selected by software, please refer to the example program.

A tolerance of at least 5% must be maintained to avoid unknown routines within the operating system (DOS), such as disk I/O that can be very time consuming. Therefore if the time out period has been set to 10 seconds, the I/O port 543H must be read within 7 seconds.

Note: when exiting a program it is necessary to disable the WatchDog Timer, otherwise the system will reset.

Example assembly program:

```
TIMER_PORT    = 543H
TIMER_START   = 543H
TIMER_STOP    = 943H
```

```
:: INITIAL TIME PERIOD COUNTER
MOV DX, TIME_PORT
OUT AL, 8:8 SECONDS
```

```
:: ADD YOUR APPLICATION HERE
MOV DX, TIMER_START
IN AL, DX.    ;; START COUNTER
```

```
:: ADD YOUR APPLICATION HERE
W_LOOP:
MOV DX, TIMER_STOP
IN AL, DX
MOV DX, TIMER_START
IN AL, DX.    ;; RESTART COUNTER
```

```
:: ADD YOUR APPLICATION HERE
CMP EXIT_AP, 0
JNE W_LOOP
MOV DX, TIMER_STOP
IN AL, DX
;; EXIT AP
```

Appendix B. I/O Address Map

B.1 System I/O Address Map

I/O Address Map	Description
000-01F	DMA Controller #1
020-021	Interrupt Controller # 1, Master
022-023	Chipset address
040-05F	System Timer
060-06F	Standard 101/102 keyboard Controller
070-07F	Real time Clock, NMI Controller
080-0BF	DMA Page Register
0A0-0BF	Interrupt Controller # 2
0C0-0DF	DMA Controller # 2
0F0-0F0	Clear Math Coprocessor Busy
0F1-0F1	Reset Math Coprocessor
0F8-0FF	Math Coprocessor
1F0-1F8	VIR BUS Master PCI IDE Controller
200-207	Game I/O
278-27F	Reserved
2F8-2FF	Serial Port 2
378-37F	Parallel Printer Port 1
3B0-3DF	Cyrix Graphic Adapter
3F0-3F7	Floppy Disk Controller
3F8-3FF	Serial Port 1
543	Watch dog timer enable
143/943	Watch dog timer disable

PnP audio I/O map range from 220~250H (16 bytes)

MPU-401 select from 300~330H (2 bytes)

B.2 DMA channel assignments

Channel	Function
0	Available
1	Audio*
2	Floppy disk (8-bit transfer)
3	Parallel**
4	Cascade for DMA controller 1
5	Audio*
6	Available
7	Available

* Audio DMA defaults setting: DMA 1.5

Audio High DMA select: DMA 1.3

Audio Low DMA select: DMA 5.6.7

** Parallel port DMA default setting: DMA 3

Parallel port DMA select: DMA 1.3

B.3 Interrupt assignments

Interrupt #	Interrupt source
NMI	Parity error detected
IRQ 0	System timer
IRQ 1	Keyboard
IRQ 2	Interrupt from controller 2 (cascade)
IRQ 8	Real-time clock
IRQ 9	Available
IRQ 10	Available
IRQ 11	Available
IRQ 12	PS/2 mouse
IRQ 13	Numeric data processor
IRQ 14	Fixed disk controller
IRQ 15	USB controller
IRQ 3	Serial communication port 2
IRQ 4	Serial communication port 1
IRQ 5	Audio*
IRQ 6	Diskette controller (FDC)
IRQ 7	Parallel port 1 (print port)

* Audio default setting: IRQ5

Ethernet IRQ is automatic set by the system

B.4 1st MB memory map

Address	Description
F000h-FFFFh	System ROM
D800h-EFFFh	Unused
C800h-D7FFh	Ethernet ROM*
C000h-C7FFh	Expansion ROM*
B800h-BFFFh	CGA/EGA/VGA text
B000h-B7FFh	Unused
A000h-AFFFh	EGA/VGA graphics
0000h-9FFFh	Base memory
D000-D400H	Available

* Default setting

** If Ethernet boot ROM is enabled.