

WAFER-5825

**Low Power GX1-300 MMX
with SVGA/LCD, CardBus
Ethernet, & Audio SBC.
Ver 1.2**

Copyright Notice

©Copyright 2001 by ICP Electronics Inc. All Rights Reserved. Manual first edition May 1, 2001.

The information in this document is subject to change without prior notice in order to improve reliability, design and function and does not represent a commitment on the part of the manufacturer.

In no event will the manufacturer be liable for direct, indirect, special, incidental, or consequential damages arising out of the use or inability to use the product or documentation, even if advised of the possibility of such damages.

This document contains proprietary information protected by copyright. All rights are reserved. No part of this manual may be reproduced by any mechanical, electronic, or other means in any form without prior written permission of the manufacturer.

Trademarks

WAFER-5825 is a registered trademark of ICP Electronics Inc. IBM PC is a registered trademark of International Business Machines Corporation. Intel is a registered trademark of Intel Corporation. Other product names mentioned herein are used for identification purposes only and may be trademarks and/or registered trademarks of their respective companies

Contents

Introduction	4
1.1 Specifications.....	4
1.2 What You Have.....	6
Installation	7
2.1 Wafer-5825 Block Diagram & Board Layout.....	7
2.2 Unpacking Precautions.....	9
2.3 System Memory DRAM	9
2.4 Watch-Dog Timer Setting.....	9
2.5 Clear CMOS Setup.....	10
2.6 LCD Vcc Voltage Selector.....	10
Connection	11
3.1 PCI E-IDE Disk Drive Connector (CN2)	11
3.2 Parallel Port (CN11).....	13
3.3 Serial Ports (CN14, CN12).....	13
3.4 Audio Connector	14
3.5 Keyboard & PS/2 Mouse Connector (CN16).....	15
3.6 USB Port Connector (CN17).....	15
3.7 IrDA Infrared Interface Port (CN5).....	16
3.8 VGA Connector (CN13)	16
3.9 LCD Interface Connector	16
3.10 LAN RJ45 Connector	18
3.11 External Power Connector	18
3.12 Power and HDD LEDS.....	19
3.13 Reset Button.....	19
3.14 Debug Port	19
3.15 CardBus Connector	19
3.16 Buzzer Connector	20

AWARD BIOS Setup	21
4.1 GETTING START.....	21
4.2 STANDARD CMOS SETUP.....	22
4.3 BIOS FEATURES SETUP.....	24
4.4 CHIPSET FEATURES SETUP.....	25
4.5 POWER MANAGEMENT SETUP.....	26
4.6 PNP / PCI CONFIGURATION.....	27
4.7 LOAD BIOS DEFAULTS.....	28
4.8 LOAD SETUP DEFAULTS.....	29
4.9 INTEGRATED PERIPHERALS.....	30
4.10 SUPERVISOR PASSWORD AND USER PASSWORD.....	32
4.11 IDE HDD AUTODETECTION.....	33
4.12 SAVE & EXIT SETUP.....	34
4.13 EXIT WITHOUT SAVING.....	35
SVGA Setup	36
5.1 Introduction.....	36
5.2 Further Information.....	37
Audio	38
6.1 Introduction.....	38
PCI Bus Ethernet Interface	39
7.1 Introduction.....	39
CardBus Interface	40
8.1 Introduction.....	40
8.2 Support.....	41
8.3 Software Support.....	41
Appendix A. Watch-Dog Timer	42
Appendix B. I/O Address Map	45

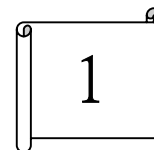

Introduction

WAFER-5825 is designed for limited space applications with only the size of a 3½" hard drive. It supports the full functions of an AT-compatible industrial computer on a single board. The WAFER-5825 is equipped with a low-power consumption and high performance GX1-300 processor on board. It also contains an SDRAM SODIMM socket that can support up to 512MB memory.

The WAFER-5825 provides an Ethernet interface, audio interface, EIDE interface, one CardBus interface, one parallel port, two serial RS-232 ports, two USB ports, and a mini-DIN PS/2 keyboard/mouse interface. The built-in SVGA/LCD display controller supports both the CRT and LCD display simultaneously. It offers the resolutions of LCD screen up to 800 x 600 and CRT resolutions up to 1280 x 1024 @ 16 colors. The display type is configured by software utility. The Flash ROM contains both the system BIOS and the VGA BIOS. The modification, in case of necessary, could be done by reprogramming the Flash ROM.

1.1 Specifications

***NS GX1-300 MMX 32-Bit x86 Processor**

- Supports Intel MMX instruction set extension for the acceleration of multi media applications
- 16 KB unified L1 cache
- Five-stage pipelined integer unit
- Integrated Floating Point Unit (FPU)

***System memory:** One 144-pin SODIMM socket support up to 512 MB SDRAM

***BIOS:** AWARD 256 KB Flash memory

***Display Controller**

MediaGx processor has applied the UMA technology that

provides 1-4MB display memory, to be set up by BIOS
Supports CRT and TFT LCD displays simultaneously
Supports 18-bit TFT LCD panel resolution up to 1024x768 @ 18bpp
Supports non-interlaced CRT monitor's resolutions up to [1280x1024 @ 256](#) colors or 1024x768 @ 16bpp

***Audio**

Compliant to AC97, support stereo
Connector: Speaker, Mic-in, Line-in, Line-out, CD-ROM in

***IDE interface:** The IDE support to two PCI Enhanced IDE hard drives

***CardBus interface:** one PC Card 95/97 compliant sockets interface supports the 32-bit CardBus (Card-32) and 16-bit CardBus (Card-16) without external buffers. Also, support ZV (Zoom Video) Card control interface without external buffers

***Serial ports:** two RS232 ports

***Parallel port:** One Parallel port, supports SPP/EPP/ECP mode, IEEE 1284 compatible.

***PS/2 Mouse/Keyboard connector:** A6-pin mini DIN connector is located on the mounting bracket for easy connection to a keyboard or PS/2 mouse

***USB interface:** two USB ports, USB 1.0 compliant

***Power management:** supports power saving modes including Normal/Doze/Sleep modes. APM1.1 compliant

***WatchDog timer:** can be set to 1-255 second's period. Reset was generated when CPU did not periodically trigger the timer.

***10/100Mbps Ethernet Controller:** Realtek RTL8139 IEEE802.u 100 BASE-TX standard Dual Auto-sensing interface to 10MBps or 100MBps networks. On board RJ45 connector provides easy connection.

***Power supply:** +12V (11.75V to 12.25V) @0.7A (typical)

***Operating temperature:** -20-60°C (-4-140°F)

***Dimension:** 5.9" (L) x4.2" (W) (145mmx102mm)

1.2 What You Have

Before you begin installing the product, please check if the following materials are included in the package:

- 1 Wafer-5825 All-in-one single board computer
- 1 CD disk for utility and drivers
- 1 2.5" IDE flat cable (44-pin 2.0mm pitch to 44-pin 2.0mm pitch)
- 1 one to two 6pin mini Din connector for keyboard and mouse
- 1 serial port cable
- 1 standard D25 connector for parallel cable
- 1 audio cable
- 1 Power cable
- 1 Buzzer cable

If any of these items are missing or damaged, contact your distributor or sales representative immediately.

2

Installation

This chapter gives instructions about how to set up the WAFER-5825 hardware, including directions of setting jumpers and connecting peripherals, switches and indicators. Before installation, please pay attention to the unpacking precautions on the following page for safety.

2.1 Wafer-5825 Block Diagram & Board Layout

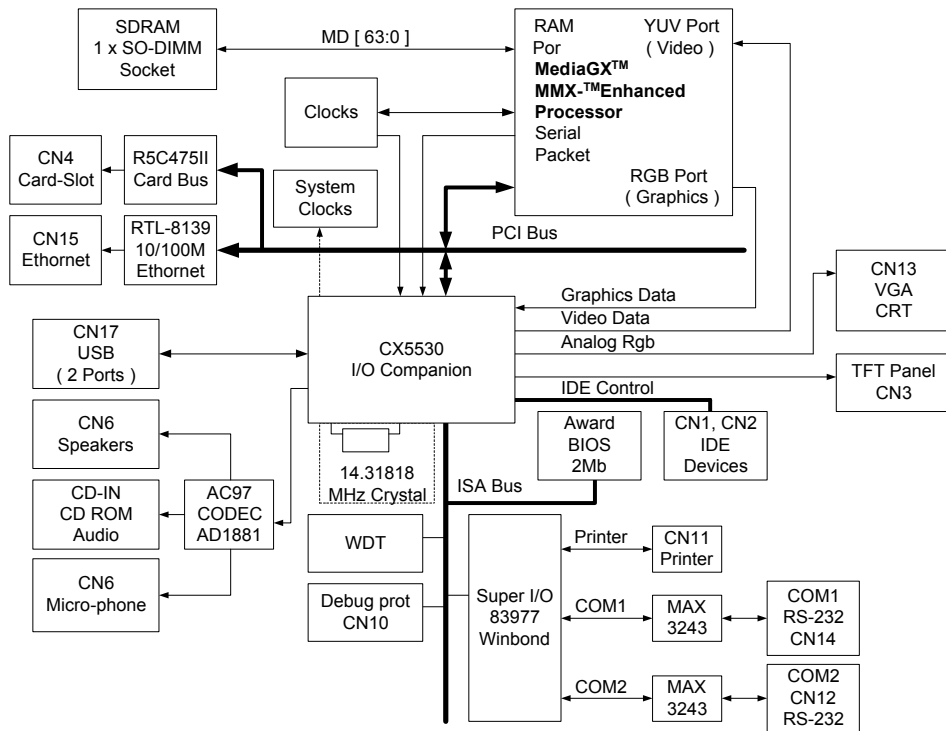

Wafer-5825 Block diagram

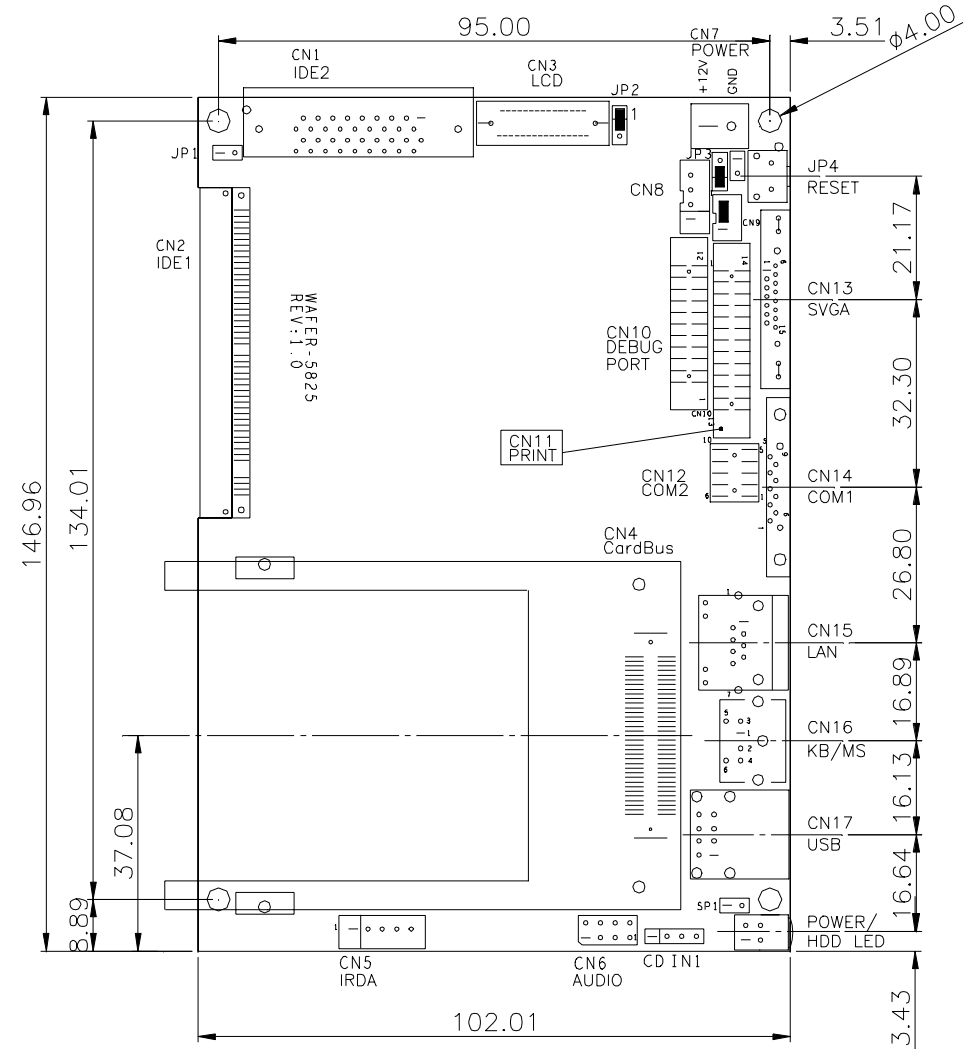

Wafer-5825 Board Layout

2.2 Unpacking Precautions

Some components of WAFER-5825 SBC are very sensitive to static electric charges and can be damaged by a sudden rush of power. To protect it from unintended damage, be sure to note these precautions:

Ground yourself to remove any static charge before touching the Wafer-5825 SBC. You can do it by using a grounded wrist strap at all times or by frequently touching any conducting materials that is connected to the ground.

Handle your Wafer-5825 SBC by its edges. Don't touch IC chips, leads or circuitry if not necessary.

Do not plug any connector or jumper while the power is on.

2.3 System Memory DRAM

There is one 144-pin SO-DIMM socket to accept 3.3V non-buffered SDRAM. The max Memory size is 512MB.

2.4 Watch-Dog Timer Setting

The Watch-Dog Timer is enabled by reading port 543H. It should be triggered before the time-out period ends, otherwise it will assume the program operation is abnormal and will issue a reset signal to restart. The Watch-Dog Timer is disabled by reading port 143/943H. For Detail information on Watch-Dog Timer, Refer to Appendix A

- JP1: Watch-Dog Active Type Setting

JP1	DESCRIPTION
SHORT	RESET WHEN WDT TIME-OUT
OPEN	DISABLE WDT

2.5 Clear CMOS Setup

If you have to clear the CMOS Setup (for example, if you forgot the password, you should clear the CMOS and then set the password again.), you should close the JP3 (Pin2 and Pin3) about 3 seconds, then open it again. Opening JP3 can set the CMOS back to normal operation mode,

- JP3 Clear CMOS Setup (Reserved Function)

JP3	DESCRIPTION
1-2	Normal Operation
2-3	Clear CMOS Setup

2.6 LCD Vcc Voltage Selector

The LCD interface connector CN3 can provide 5V or 3.3V power supply by selecting the JP2 to meet the different LCD requirement.

JP2	DESCRIPTION
1-2	5V
2-3	3.3V

3

Connection

This chapter describes how to connect peripherals, switches and indicators to the WAFER-5825 board.

3.1 PCI E-IDE Disk Drive Connector (CN2)

For IDE HDD connection, The Wafer-5825 was designed with one 2.0mm connector (CN2), which could be converted to two 2.54mm standard IDE connector via proprietary cable. Using this cable you can attach two IDE hard disk drives to the WAFER-5825.

CN2: 44-pin Primary Mini-pitched IDE Interface Connector

- CN2: Primary IDE Interface Connector

PIN NO.	DESCRIPTION	PIN NO.	DESCRIPTION
1	RESET#	2	GROUND
3	DATA 7	4	DATA 8
5	DATA 6	6	DATA 9
7	DATA 5	8	DATA 10
9	DATA 4	10	DATA 11
11	DATA 3	12	DATA 12
13	DATA 2	14	DATA 13
15	DATA 1	16	DATA 14
17	DATA 0	18	DATA 15
19	GROUND	20	N/C
21	IDE DRQ	22	GROUND
23	IOW#	24	GROUND
25	IOR#	26	GROUND
27	IDE CHRDY	28	GROUND

29	IDE DACK	30	GROUND-DEFAULT
31	INTERRUPT	32	N/C
33	SA1	34	N/C
35	SA0	36	SA2
37	HDC CS0#	38	HDC CS1#
39	HDD ACTIVE#	40	GROUND
41	VCC	42	GROUND
43	GROUND	44	GROUND

- CN1: Secondly IDE Interface Connector

PIN NO.	DESCRIPTION	PIN NO.	DESCRIPTION
1	RESET#	19	GROUND
2	GROUND	20	N/C
3	DATA 7	21	IDE DRQ
4	DATA 8	22	GROUND
5	DATA 6	23	IOW#
6	DATA 9	24	HDC CS0#
7	DATA 5	25	IOR#
8	DATA 10	26	GROUND
9	DATA 4	27	IDE CHRDY
10	DATA 11	28	HDC CS1#
11	DATA 3	29	IDE DACK
12	DATA 12	30	GROUND
13	DATA 2	31	INTERRUPT
14	DATA 13	32	N/C
15	DATA 1	33	SA1
16	DATA 14	34	GROUND
17	DATA 0	35	SA0
18	DATA 15	36	SA2

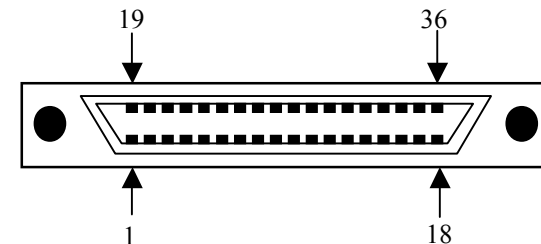

3.2 Parallel Port (CN11)

This port is usually connected to a printer. The WAFER-5825 includes an on-board parallel port (CN11), accessed through a 26-pin flat-cable connector.

- CN11: Parallel Port Connector

PIN NO.	DESCRIPTION	PIN NO.	DESCRIPTION
1	STROBE#	2	DATA 0
3	DATA 1	4	DATA 2
5	DATA 3	6	DATA 4
7	DATA 5	8	DATA 6
9	DATA 7	10	ACKNOWLEDGE
11	BUSY	12	PAPER EMPTY
13	PRINTER SELECT	14	AUTO FORM FEED #
15	ERROR#	16	INITIALIZE
17	PRINTER SELECT LN#	18	GROUND
19	GROUND	20	GROUND
21	GROUND	22	GROUND
23	GROUND	24	GROUND
25	GROUND	26	N/C

3.3 Serial Ports (CN14, CN12)

The Wafer-5825 offers two high speeds NS16C550 compatible UARTS with Read/Receive 16 byte FIFO. These ports let you connect to serial devices or a communication network. One 9-pin D-SUB connector and one 10-pin header are provided by the WAFER-5825. The detailed pin assignment of the connectors are specified as following tables:

- CN14: Serial Port1 Connector (9-pin DSUB)

PIN NO.	DESCRIPTION
1	DATA CARRIER DETECT (DCD)
2	RECEIVE DATA (RXD)
3	TRANSMIT DATA (TXD)
4	DATA TERMINAL READY (DTR)
5	GROUND (GND)
6	DATA SET READY (DSR)
7	REQUEST TO SEND (RTS)
8	CLEAR TO SEND (CTS)
9	RING INDICATOR (RI)

- CN12: Serial Port2 Connector (10-pin 2.0mm Header)

PIN NO.	DESCRIPTION	PIN NO.	DESCRIPTION
1	DCD	2	DSR
3	RX	4	RTS
5	TX	6	CTS
7	DTR	8	RI
9	GND	10	N/C

3.4 Audio Connector

The audio function was organized by CX5530 I/O companions and AC97 CODEC. You can use CD-IN as the input port (e.g.: connected to the output of CD player), depending on the type of connector that you have.

- CD-IN: CD_AUDIO INPUT Connector

PIN NO.	DESCRIPTION
1	JCD_R
2	GND
3	GND
4	JCD_L

- CN6: Audio Connector

This is the output port of your Sound System. Pin 1-3 can be connected to earphone or loudspeaker. Pin 5-6 can be used as input port if it is connected to the earphone jack of your CD. Pin 7-8 is for microphone.

PIN NO.	DESCRIPTION	PIN NO.	DESCRIPTION
1	LINE OUT L	2	GND
3	LINE OUT R	4	GND
5	LINE IN R	6	LINE IN L
7	MIC	8	GND

3.5 Keyboard & PS/2 Mouse Connector (CN16)

A 6-pin mini DIN connector (CN16) is located on the mounting bracket for easy connection to a keyboard or PS/2 mouse. The card comes with a cable to convert the 6-pin mini-DIN connector to two 6-pin mini-DIN connector for keyboard and mouse connection

- CN16: 6-pin Mini-DIN Keyboard & Mouse Connector

PIN NO.	DESCRIPTION
1	KEYBOARD DATA
2	MOUSE DATA
3	GROUND
4	+5V
5	KEYBOARD CLOCK
6	MOUSE CLOCK

3.6 USB Port Connector (CN17)

The WAFER-5825 provides two USB interfaces, which gives the complete plug and play, for up to 127 external devices.

- CN17: Internal USB Connector

1.	USBVCC1	2.	D1-
3.	D1+	4.	GND

5.	USBVCC2	6.	D2-
7.	D2+	8.	GND
9.	GND	10.	GND

3.7 IrDA Infrared Interface Port (CN5)

The WAFER-5825's built-in an IrDA port which supports Serial Infrared (SIR) or Amplitude Shift Keyed IR (ASKIR) interface. Using the IrDA port have to set SIR or ASKIR model in the BIOS's Peripheral Setup's COM2. Then the normal RS-232 COM2 will be disabled.

- CN5: IrDA connector

PIN NO.	DESCRIPTION
1	VCC
2	NC
3	IRRX
4	Ground
5	IR-TX

3.8 VGA Connector (CN13)

The WAFER-5825's built-in 15-pin VGA connector accepts the CRT monitor.

- CN13: 15-pin Female Connector

1	RED	2	GREEN
3	BLUE	4	NC
5	GROUND	6	GROUND
7	GROUND	8	GROUND
9	NC	10	GROUND
11	NC	12	DDC DAT
13	HSYNC	14	VSYNC
15	DDCCLK		

3.9 LCD Interface Connector

The WAFER-5825 provides a 31-pin connector for the LCD flat panel interface .The Wafer-5825 comes to support TFT

LCD panels at following display options: (This is a reference table only, may support more panels)

Video Display type	Resolution	Example
TFT VGA	640X480 , 64K Color , 18bits	Toshiba LTM10C209A
TFT SVGA	800X600 , 64K Color , 18bits	Toshiba LTM12C275A
TFT XVGA	1024X768 , 64K Color , 18bits	LG LM151X1

The display options need to be setup manually from BIOS. The BIOS **“Integrated Peripheral”** Setup will allow you to choose display resolution either 640X480 or 800X600, 1024X768.

- CN3: LCD Interface Connector – only supports up to 18 bit LCD. For better display quality, the length of LCD cable should be shorter than 35 cm.



PIN NO.	FUNCTION	PIN NO.	FUNCTION
1	GND	2	SHFCLK
3	LP	4	FLM
5	GND	6	RED0
7	RED1	8	RED2
9	RED3	10	RED4
11	RED5	12	GND
13	GREEN0	14	GREEN1
15	GREEN2	16	GREEN3
17	GREEN4	18	GREEN5
19	GND	20	BLUE0
21	BLUE1	22	BLUE2
23	BLUE3	24	BLUE4
25	BLUE5	26	GND
27	M	* 28	PLCD

29	PLCD	30	PLCD
31	NC		

<Note> Pin 28,29,30 “PLCD”, the voltage of LCD can be selected 5V or 3.3V by the jumper JP2.

- CN8: LCD Inverter Connector

PIN NO.	DESCRIPTION
1	+12V
2	ENABKL
3	GND
4	GND

3.10 LAN RJ45 Connector

The WAFER-5825’s built-in RJ45 LAN connector is for 10/100Mbps Ethernet (RTL8139C).

- CN15: LAN RJ45 Connector

PIN NO.	DESCRIPTION	PIN NO.	DESCRIPTION
1	TX+	5	NC
2	TX-	6	RX-
3	RX+	7	NC
4	NC	8	NC

- Ethernet LED setup

LED	ACTIVE INDICATION
Green lamp	RX
Orange lamp	TX

3.11 External Power Connector

The WAFER-5825 has an on-board external power connector CN7. You can connect power directly to the CPU board.

- CN7: External Power Connector

PIN NO.	DESCRIPTION
1	+12V
2	GROUND

3.12 Power and HDD LEDS

- D2: Power / HDD setup

LED	ACTIVE INDICATION
Green lamp	Power
Orange lamp	HDD

3.13 Reset Button

- JP4: Reset Button

PIN NO.	DESCRIPTION
1	RESET
2	GND

3.14 Debug Port

This port is used for debugging only (I/O Port 80H)

- CN10: Debug Card Connector

PIN NO.	Description	PIN NO.	Description
1	SD0	2	+5V
3	SD1	4	SA0
5	SD2	6	SA1
7	SD3	8	SA2
9	SD4	10	SA3
11	SD5	12	SA4
13	SD6	14	SA5
15	SD7	16	SA6
17	NC	18	SA7
19	RSTDRV	20	IOW#
21	GND	22	AEN

3.15 CardBus Connector

The WAFER-5825 built-in a CardBus interface connector (CN4)

- CN4: CardBus Connector

PIN NO.	FUNCTION	PIN NO.	FUNCTION
1	GND	2	D3
3	D4	4	D5
5	D6	6	D7
7	CE1#	8	A10
9	OE#	10	A11
11	A9	12	A8
13	A13	14	A14
15	WE#	16	READY
17	VCC	18	VCC
19	A16	20	A15
21	A12	22	A7
23	A6	24	A5
25	A4	26	A3
27	A2	28	A1
29	A0	30	D0
31	D1	32	D2
33	WP	34	GND
35	GND	36	CD1#
37	D11	38	D12
39	D13	40	D14
41	D15	42	CE2#
43	VS1#	44	IORD#
45	IOWR#	46	A17
47	A18	48	A19
49	A20	50	A21
51	VCC	52	VCC
53	A22	54	A23
55	A24	56	A25
57	VS2#	58	RESET
59	WAIT#	60	INPACK#
61	REG#	62	BVD2
63	BVD1	64	D8
65	D9	66	D10
67	CD2#	68	GND
69	GND	70	GND

3.16 Buzzer Connector

- SP1: Buzzer Connector

PIN NO.	DESCRIPTION
1	PCBEEP
2	GND

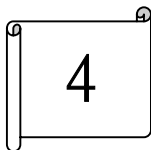

AWARD BIOS Setup

WAFER-5825 uses the AWARD PCI/ISA BIOS for system configuration. The AWARD BIOS setup program is designed to provide maximum flexibility in configuring the system by offering various options that may be selected to meet end-user requirements. This chapter is written to assist you in the proper usage of these features.

4.1 GETTING START

When you turn on the power button, the BIOS will enter the Power-On-Self-Test routines. These routines will be executed for system test and initialization and system configuration verification. After the POST routines are completed, the following message appears:

" Hit DEL if you want to run SETUP"

```

ROM PCI/ISA BIOS (2A43419E)
CMOS SETUP UTILITY
AWARD SOFTWARE, INC.

```

STANDARD CMOS SETUP	INTEGRATED PERIPHERALS
BIOS FEATURES SETUP	SUPERVISOR PASSWORD
CHIPSET FEATURES SETUP	USER PASSWORD
POWER MANAGEMENT SETUP	IDE HDD AUTO DETECTION
PNP/PCI CONFIGURATION	SAVE & EXIT SETUP
LOAD BIOS DEFAULTS	EXIT WITHOUT SAVING
LOAD SETUP DEFAULTS	

```

Esc : Quit
F10 : Save & Exit Setup
F1 : ← : Select Item
(Shift)F2 : Change Color

```

To access AWARD BIOS SETUP UTILITY, press key. The following screen will be displayed at this time:

4.2 STANDARD CMOS SETUP

The Standard CMOS Setup is used for basic hardware system configuration. The main function is for Date/Time setting and Floppy/Hard Disk Drive setting. Please refer the following screen for this setup.

```

ROM BIOS SETUP UTILITY - Award BIOS
LOADING SETUP PROGRAM
AWARD SOFTWARE, INC.

```

FIELD	DATE	TIME	DISK	HD0	HD1	FD0	FD1	FD2	FD3	FD4	FD5	FD6	FD7	FD8	FD9	FD10	FD11	FD12	FD13	FD14	FD15	FD16	FD17	FD18	FD19	FD20	FD21	FD22	FD23	FD24	FD25	FD26	FD27	FD28	FD29	FD30	FD31	FD32	FD33	FD34	FD35	FD36	FD37	FD38	FD39	FD40	FD41	FD42	FD43	FD44	FD45	FD46	FD47	FD48	FD49	FD50	FD51	FD52	FD53	FD54	FD55	FD56	FD57	FD58	FD59	FD60	FD61	FD62	FD63	FD64	FD65	FD66	FD67	FD68	FD69	FD70	FD71	FD72	FD73	FD74	FD75	FD76	FD77	FD78	FD79	FD80	FD81	FD82	FD83	FD84	FD85	FD86	FD87	FD88	FD89	FD90	FD91	FD92	FD93	FD94	FD95	FD96	FD97	FD98	FD99	FD100	FD101	FD102	FD103	FD104	FD105	FD106	FD107	FD108	FD109	FD110	FD111	FD112	FD113	FD114	FD115	FD116	FD117	FD118	FD119	FD120	FD121	FD122	FD123	FD124	FD125	FD126	FD127	FD128	FD129	FD130	FD131	FD132	FD133	FD134	FD135	FD136	FD137	FD138	FD139	FD140	FD141	FD142	FD143	FD144	FD145	FD146	FD147	FD148	FD149	FD150	FD151	FD152	FD153	FD154	FD155	FD156	FD157	FD158	FD159	FD160	FD161	FD162	FD163	FD164	FD165	FD166	FD167	FD168	FD169	FD170	FD171	FD172	FD173	FD174	FD175	FD176	FD177	FD178	FD179	FD180	FD181	FD182	FD183	FD184	FD185	FD186	FD187	FD188	FD189	FD190	FD191	FD192	FD193	FD194	FD195	FD196	FD197	FD198	FD199	FD200	FD201	FD202	FD203	FD204	FD205	FD206	FD207	FD208	FD209	FD210	FD211	FD212	FD213	FD214	FD215	FD216	FD217	FD218	FD219	FD220	FD221	FD222	FD223	FD224	FD225	FD226	FD227	FD228	FD229	FD230	FD231	FD232	FD233	FD234	FD235	FD236	FD237	FD238	FD239	FD240	FD241	FD242	FD243	FD244	FD245	FD246	FD247	FD248	FD249	FD250	FD251	FD252	FD253	FD254	FD255	FD256	FD257	FD258	FD259	FD260	FD261	FD262	FD263	FD264	FD265	FD266	FD267	FD268	FD269	FD270	FD271	FD272	FD273	FD274	FD275	FD276	FD277	FD278	FD279	FD280	FD281	FD282	FD283	FD284	FD285	FD286	FD287	FD288	FD289	FD290	FD291	FD292	FD293	FD294	FD295	FD296	FD297	FD298	FD299	FD300	FD301	FD302	FD303	FD304	FD305	FD306	FD307	FD308	FD309	FD310	FD311	FD312	FD313	FD314	FD315	FD316	FD317	FD318	FD319	FD320	FD321	FD322	FD323	FD324	FD325	FD326	FD327	FD328	FD329	FD330	FD331	FD332	FD333	FD334	FD335	FD336	FD337	FD338	FD339	FD340	FD341	FD342	FD343	FD344	FD345	FD346	FD347	FD348	FD349	FD350	FD351	FD352	FD353	FD354	FD355	FD356	FD357	FD358	FD359	FD360	FD361	FD362	FD363	FD364	FD365	FD366	FD367	FD368	FD369	FD370	FD371	FD372	FD373	FD374	FD375	FD376	FD377	FD378	FD379	FD380	FD381	FD382	FD383	FD384	FD385	FD386	FD387	FD388	FD389	FD390	FD391	FD392	FD393	FD394	FD395	FD396	FD397	FD398	FD399	FD400	FD401	FD402	FD403	FD404	FD405	FD406	FD407	FD408	FD409	FD410	FD411	FD412	FD413	FD414	FD415	FD416	FD417	FD418	FD419	FD420	FD421	FD422	FD423	FD424	FD425	FD426	FD427	FD428	FD429	FD430	FD431	FD432	FD433	FD434	FD435	FD436	FD437	FD438	FD439	FD440	FD441	FD442	FD443	FD444	FD445	FD446	FD447	FD448	FD449	FD450	FD451	FD452	FD453	FD454	FD455	FD456	FD457	FD458	FD459	FD460	FD461	FD462	FD463	FD464	FD465	FD466	FD467	FD468	FD469	FD470	FD471	FD472	FD473	FD474	FD475	FD476	FD477	FD478	FD479	FD480	FD481	FD482	FD483	FD484	FD485	FD486	FD487	FD488	FD489	FD490	FD491	FD492	FD493	FD494	FD495	FD496	FD497	FD498	FD499	FD500	FD501	FD502	FD503	FD504	FD505	FD506	FD507	FD508	FD509	FD510	FD511	FD512	FD513	FD514	FD515	FD516	FD517	FD518	FD519	FD520	FD521	FD522	FD523	FD524	FD525	FD526	FD527	FD528	FD529	FD530	FD531	FD532	FD533	FD534	FD535	FD536	FD537	FD538	FD539	FD540	FD541	FD542	FD543	FD544	FD545	FD546	FD547	FD548	FD549	FD550	FD551	FD552	FD553	FD554	FD555	FD556	FD557	FD558	FD559	FD560	FD561	FD562	FD563	FD564	FD565	FD566	FD567	FD568	FD569	FD570	FD571	FD572	FD573	FD574	FD575	FD576	FD577	FD578	FD579	FD580	FD581	FD582	FD583	FD584	FD585	FD586	FD587	FD588	FD589	FD590	FD591	FD592	FD593	FD594	FD595	FD596	FD597	FD598	FD599	FD600	FD601	FD602	FD603	FD604	FD605	FD606	FD607	FD608	FD609	FD610	FD611	FD612	FD613	FD614	FD615	FD616	FD617	FD618	FD619	FD620	FD621	FD622	FD623	FD624	FD625	FD626	FD627	FD628	FD629	FD630	FD631	FD632	FD633	FD634	FD635	FD636	FD637	FD638	FD639	FD640	FD641	FD642	FD643	FD644	FD645	FD646	FD647	FD648	FD649	FD650	FD651	FD652	FD653	FD654	FD655	FD656	FD657	FD658	FD659	FD660	FD661	FD662	FD663	FD664	FD665	FD666	FD667	FD668	FD669	FD670	FD671	FD672	FD673	FD674	FD675	FD676	FD677	FD678	FD679	FD680	FD681	FD682	FD683	FD684	FD685	FD686	FD687	FD688	FD689	FD690	FD691	FD692	FD693	FD694	FD695	FD696	FD697	FD698	FD699	FD700	FD701	FD702	FD703	FD704	FD705	FD706	FD707	FD708	FD709	FD710	FD711	FD712	FD713	FD714	FD715	FD716	FD717	FD718	FD719	FD720	FD721	FD722	FD723	FD724	FD725	FD726	FD727	FD728	FD729	FD730	FD731	FD732	FD733	FD734	FD735	FD736	FD737	FD738	FD739	FD740	FD741	FD742	FD743	FD744	FD745	FD746	FD747	FD748	FD749	FD750	FD751	FD752	FD753	FD754	FD755	FD756	FD757	FD758	FD759	FD760	FD761	FD762	FD763	FD764	FD765	FD766	FD767	FD768	FD769	FD770	FD771	FD772	FD773	FD774	FD775	FD776	FD777	FD778	FD779	FD780	FD781	FD782	FD783	FD784	FD785	FD786	FD787	FD788	FD789	FD790	FD791	FD792	FD793	FD794	FD795	FD796	FD797	FD798	FD799	FD800	FD801	FD802	FD803	FD804	FD805	FD806	FD807	FD808	FD809	FD810	FD811	FD812	FD813	FD814	FD815	FD816	FD817	FD818	FD819	FD820	FD821	FD822	FD823	FD824	FD825	FD826	FD827	FD828	FD829	FD830	FD831	FD832	FD833	FD834	FD835	FD836	FD837	FD838	FD839	FD840	FD841	FD842	FD843	FD844	FD845	FD846	FD847	FD848	FD849	FD850	FD851	FD852	FD853	FD854	FD855	FD856	FD857	FD858	FD859	FD860	FD861	FD862	FD863	FD864	FD865	FD866	FD867	FD868	FD869	FD870	FD871	FD872	FD873	FD874	FD875	FD876	FD877	FD878	FD879	FD880	FD881	FD882	FD883	FD884	FD885	FD886	FD887	FD888	FD889	FD890	FD891	FD892	FD893	FD894	FD895	FD896	FD897	FD898	FD899	FD900	FD901	FD902	FD903	FD904	FD905	FD906	FD907	FD908	FD909	FD910	FD911	FD912	FD913	FD914	FD915	FD916	FD917	FD918	FD919	FD920	FD921	FD922	FD923	FD924	FD925	FD926	FD927	FD928	FD929	FD930	FD931	FD932	FD933	FD934	FD935	FD936	FD937	FD938	FD939	FD940	FD941	FD942	FD943	FD944	FD945	FD946	FD947	FD948	FD949	FD950	FD951	FD952	FD953	FD954	FD955	FD956	FD957	FD958	FD959	FD960	FD961	FD962	FD963	FD964	FD965	FD966	FD967	FD968	FD969	FD970	FD971	FD972	FD973	FD974	FD975	FD976	FD977	FD978	FD979	FD980	FD981	FD982	FD983	FD984	FD985	FD986	FD987	FD988	FD989	FD990	FD991	FD992	FD993	FD994	FD995	FD996	FD997	FD998	FD999
-------	------	------	------	-----	-----	-----	-----	-----	-----	-----	-----	-----	-----	-----	-----	------	------	------	------	------	------	------	------	------	------	------	------	------	------	------	------	------	------	------	------	------	------	------	------	------	------	------	------	------	------	------	------	------	------	------	------	------	------	------	------	------	------	------	------	------	------	------	------	------	------	------	------	------	------	------	------	------	------	------	------	------	------	------	------	------	------	------	------	------	------	------	------	------	------	------	------	------	------	------	------	------	------	------	------	------	------	------	------	------	------	-------	-------	-------	-------	-------	-------	-------	-------	-------	-------	-------	-------	-------	-------	-------	-------	-------	-------	-------	-------	-------	-------	-------	-------	-------	-------	-------	-------	-------	-------	-------	-------	-------	-------	-------	-------	-------	-------	-------	-------	-------	-------	-------	-------	-------	-------	-------	-------	-------	-------	-------	-------	-------	-------	-------	-------	-------	-------	-------	-------	-------	-------	-------	-------	-------	-------	-------	-------	-------	-------	-------	-------	-------	-------	-------	-------	-------	-------	-------	-------	-------	-------	-------	-------	-------	-------	-------	-------	-------	-------	-------	-------	-------	-------	-------	-------	-------	-------	-------	-------	-------	-------	-------	-------	-------	-------	-------	-------	-------	-------	-------	-------	-------	-------	-------	-------	-------	-------	-------	-------	-------	-------	-------	-------	-------	-------	-------	-------	-------	-------	-------	-------	-------	-------	-------	-------	-------	-------	-------	-------	-------	-------	-------	-------	-------	-------	-------	-------	-------	-------	-------	-------	-------	-------	-------	-------	-------	-------	-------	-------	-------	-------	-------	-------	-------	-------	-------	-------	-------	-------	-------	-------	-------	-------	-------	-------	-------	-------	-------	-------	-------	-------	-------	-------	-------	-------	-------	-------	-------	-------	-------	-------	-------	-------	-------	-------	-------	-------	-------	-------	-------	-------	-------	-------	-------	-------	-------	-------	-------	-------	-------	-------	-------	-------	-------	-------	-------	-------	-------	-------	-------	-------	-------	-------	-------	-------	-------	-------	-------	-------	-------	-------	-------	-------	-------	-------	-------	-------	-------	-------	-------	-------	-------	-------	-------	-------	-------	-------	-------	-------	-------	-------	-------	-------	-------	-------	-------	-------	-------	-------	-------	-------	-------	-------	-------	-------	-------	-------	-------	-------	-------	-------	-------	-------	-------	-------	-------	-------	-------	-------	-------	-------	-------	-------	-------	-------	-------	-------	-------	-------	-------	-------	-------	-------	-------	-------	-------	-------	-------	-------	-------	-------	-------	-------	-------	-------	-------	-------	-------	-------	-------	-------	-------	-------	-------	-------	-------	-------	-------	-------	-------	-------	-------	-------	-------	-------	-------	-------	-------	-------	-------	-------	-------	-------	-------	-------	-------	-------	-------	-------	-------	-------	-------	-------	-------	-------	-------	-------	-------	-------	-------	-------	-------	-------	-------	-------	-------	-------	-------	-------	-------	-------	-------	-------	-------	-------	-------	-------	-------	-------	-------	-------	-------	-------	-------	-------	-------	-------	-------	-------	-------	-------	-------	-------	-------	-------	-------	-------	-------	-------	-------	-------	-------	-------	-------	-------	-------	-------	-------	-------	-------	-------	-------	-------	-------	-------	-------	-------	-------	-------	-------	-------	-------	-------	-------	-------	-------	-------	-------	-------	-------	-------	-------	-------	-------	-------	-------	-------	-------	-------	-------	-------	-------	-------	-------	-------	-------	-------	-------	-------	-------	-------	-------	-------	-------	-------	-------	-------	-------	-------	-------	-------	-------	-------	-------	-------	-------	-------	-------	-------	-------	-------	-------	-------	-------	-------	-------	-------	-------	-------	-------	-------	-------	-------	-------	-------	-------	-------	-------	-------	-------	-------	-------	-------	-------	-------	-------	-------	-------	-------	-------	-------	-------	-------	-------	-------	-------	-------	-------	-------	-------	-------	-------	-------	-------	-------	-------	-------	-------	-------	-------	-------	-------	-------	-------	-------	-------	-------	-------	-------	-------	-------	-------	-------	-------	-------	-------	-------	-------	-------	-------	-------	-------	-------	-------	-------	-------	-------	-------	-------	-------	-------	-------	-------	-------	-------	-------	-------	-------	-------	-------	-------	-------	-------	-------	-------	-------	-------	-------	-------	-------	-------	-------	-------	-------	-------	-------	-------	-------	-------	-------	-------	-------	-------	-------	-------	-------	-------	-------	-------	-------	-------	-------	-------	-------	-------	-------	-------	-------	-------	-------	-------	-------	-------	-------	-------	-------	-------	-------	-------	-------	-------	-------	-------	-------	-------	-------	-------	-------	-------	-------	-------	-------	-------	-------	-------	-------	-------	-------	-------	-------	-------	-------	-------	-------	-------	-------	-------	-------	-------	-------	-------	-------	-------	-------	-------	-------	-------	-------	-------	-------	-------	-------	-------	-------	-------	-------	-------	-------	-------	-------	-------	-------	-------	-------	-------	-------	-------	-------	-------	-------	-------	-------	-------	-------	-------	-------	-------	-------	-------	-------	-------	-------	-------	-------	-------	-------	-------	-------	-------	-------	-------	-------	-------	-------	-------	-------	-------	-------	-------	-------	-------	-------	-------	-------	-------	-------	-------	-------	-------	-------	-------	-------	-------	-------	-------	-------	-------	-------	-------	-------	-------	-------	-------	-------	-------	-------	-------	-------	-------	-------	-------	-------	-------	-------	-------	-------	-------	-------	-------	-------	-------	-------	-------	-------	-------	-------	-------	-------	-------	-------	-------	-------	-------	-------	-------	-------	-------	-------	-------	-------	-------	-------	-------	-------	-------	-------	-------	-------	-------	-------	-------	-------	-------	-------	-------	-------	-------	-------	-------	-------	-------	-------	-------	-------	-------	-------	-------	-------	-------	-------	-------	-------	-------	-------	-------	-------	-------	-------	-------	-------	-------	-------	-------	-------	-------	-------	-------	-------	-------	-------	-------	-------	-------	-------	-------	-------	-------	-------	-------	-------	-------	-------	-------	-------	-------	-------	-------	-------	-------	-------	-------	-------	-------	-------	-------	-------	-------	-------	-------	-------	-------	-------	-------	-------	-------	-------	-------	-------	-------	-------	-------	-------	-------	-------	-------	-------	-------	-------	-------	-------	-------	-------	-------	-------	-------	-------	-------	-------	-------	-------	-------	-------	-------	-------	-------	-------	-------	-------	-------	-------	-------	-------	-------	-------	-------	-------	-------	-------	-------	-------	-------	-------	-------	-------	-------	-------	-------	-------	-------	-------	-------	-------	-------	-------	-------	-------	-------	-------	-------

```

Date: 01/01/98
Time: 00:00
Disk: 2.88
HD0: 3.0
HD1: 3.0
FD0: 2.88
FD1: 2.88
FD2: 2.88
FD3: 2.88
FD4: 2.88
FD5: 2.88
FD6: 2.88
FD7: 2.88
FD8: 2.88
FD9: 2.88
FD10: 2.88
FD11: 2.88
FD12: 2.88
FD13: 2.88
FD14: 2.88
FD15: 2.88
FD16: 2.88
FD17: 2.88
FD18: 2.88
FD19: 2.88
FD20: 2.88
FD21: 2.88
FD22: 2.88
FD23: 2.88
FD24: 2.88
FD25: 2.88
FD26: 2.88
FD27: 2.88
FD28: 2.88
FD29: 2.88
FD30: 2.88
FD31: 2.88
FD32: 2.88
FD33: 2.88
FD34: 2.88
FD35: 2.88
FD36: 2.88
FD37: 2.88
FD38: 2.88
FD39: 2.88
FD40: 2.88
FD41: 2.88
FD42: 2.88
FD43: 2.88
FD44: 2.88
FD45: 2.88
FD46: 2.88
FD47: 2.88
FD48: 2.88
FD49: 2.88
FD50: 2.88
FD51: 2.88
FD52: 2.88
FD53: 2.88
FD54: 2.88
FD55: 2.88
FD56: 2.88
FD57: 2.88
FD58: 2.88
FD59: 2.88
FD60: 2.88
FD61: 2.88
FD62: 2.88
FD63: 2.88
FD64: 2.88
FD65: 2.88
FD66: 2.88
FD67: 2.88
FD68: 2.88
FD69: 2.88
FD70: 2.88
FD71: 2.88
FD72: 2.88
FD73: 2.88
FD74: 2.88
FD75: 2.88
FD76: 2.88
FD77: 2.88
FD78: 2.88
FD79: 2.88
FD80: 2.88
FD81: 2.88
FD82: 2.88
FD83: 2.88
FD84: 2.88
FD85: 2.88
FD86: 2.88
FD87: 2.88
FD88: 2.88
FD89: 2.88
FD90: 2.88
FD91: 2.88
FD92: 2.88
FD93: 2.88
FD94: 2.88
FD95: 2.88
FD96: 2.88
FD97: 2.88
FD98: 2.88
FD99: 2.88
FD100: 2.88
FD101: 2.88
FD102: 2.88
FD103: 2.88
FD104: 2.88
FD105: 2.88
FD106: 2.88
FD107: 2.88
FD108: 2.88
FD109: 2.88
FD110: 2.88
FD111: 2.88
FD112: 2.88
FD113: 2.88
FD114: 2.88
FD115: 2.88
FD116: 2.88
FD117: 2.88
FD118: 2.88
FD119: 2.88
FD120: 2.88
FD121: 2.88
FD122: 2.88
FD123: 2.88
FD124: 2.88
FD125: 2.88
FD126: 2.88
FD127: 2.88
FD128: 2.88
FD129: 2.88
FD130: 2.88
FD131: 2.88
```

- **Audio Low DMA Select -- DMA0, DMA1, DMA3, Disabled**
To select the high DMA channel.
- **Audio High DMA Select -- DMA5, DMA6, DMA7, Disabled**
To select the high DMA channel.
- **Multiple Monitor Support -- No Onboard, PCI first, M/B first**
To select the primary VGA for multiple monitor support in WINDOWS.
- **Video Memory Size -- 1.5M, 2.5M, 4.0M**
To select the size of Video memory. It makes use of system memory for display.

4.10 SUPERVISOR PASSWORD AND USER PASSWORD

Supervisor Password sets a password that is used to protect your system and Setup Utility. Supervisor Password has higher priority than User Password. Once you setup the password, the system will always ask you to key-in password every time you enter the BIOS SETUP. If you enter the BIOS SETUP with Supervisor Password, you can choose every setup/option on the main menu but with User Password, you can only choose three setup/options (USER PASSWORD, SAVE & EXIT SETUP and EXIT WITHOUT SAVING). To disable these passwords, enter the BIOS SETUP room with Supervisor Password and then just press the <Enter> key instead of entering a new password when the 'Enter Password' prompts pop-up.

N.B. : if you forget the password, do the Clear/Reset CMOS procedure (see Section 2.5 Clear CMOS Setup)

4.11 IDE HDD AUTODETECTION

This option detects the parameters of an IDE hard disk drive (HDD sector, cylinder, head, etc) automatically and will put the parameters into the Standard CMOS Setup screen. Up to 2 IDE drives can be detected and the parameters will be listed in the box. Press <Y> if you accept these parameters. Press <N> to skip the next IDE drives.

Note: If your IDE HDD was formatted in previous older system, incorrect parameters may be detected. In this case, you need to enter the correct parameters manually or low-level format the disk

4.12 SAVE & EXIT SETUP

Select this option when you finish setting all the parameters and want to save them into the CMOS. Just simply press <Enter> key and all the configuration changes will be saved

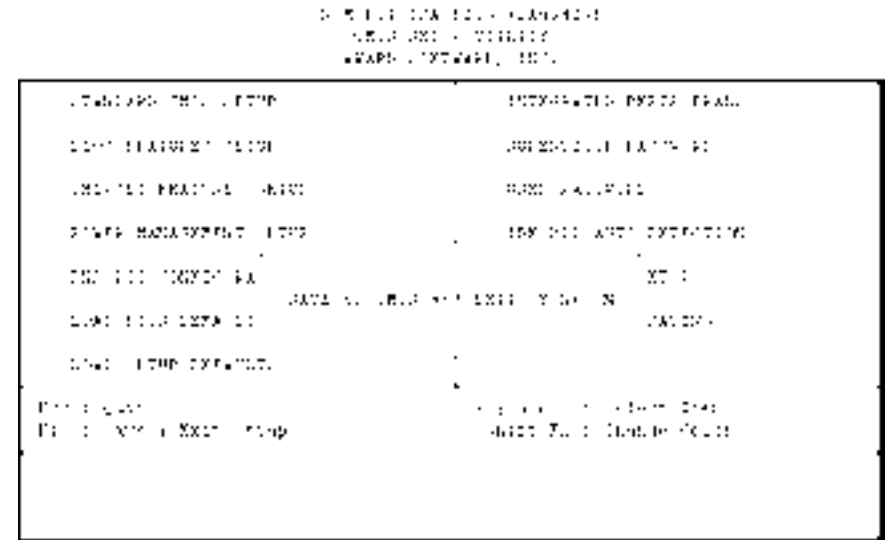

4.13 EXIT WITHOUT SAVING

Select this option if you want to exit the Setup without saving the changes that you made. Just simply press <Enter> key and you will exit the BIOS SETUP without saving the

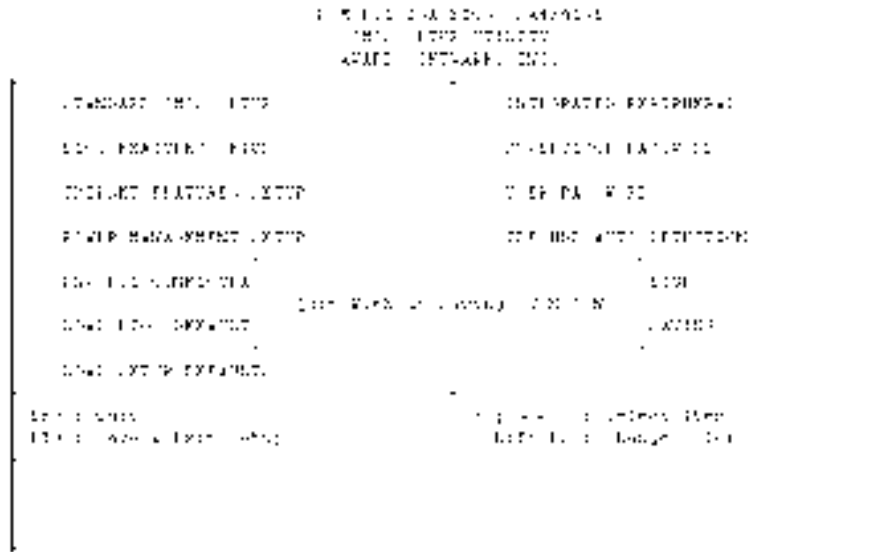

changes.

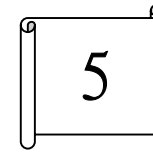

SVGA Setup

5.1 Introduction

The WAFER-5825 is equipped with on-board LCD/VGA interface. The description below is its specifications and features:

5.1.1 Chipset

The WAFER-5825 uses a Cyrix CX5530 chipset as its SVGA controller. It is compatible with many common 18-bit LCD displays and traditional analog CRT monitors. The VGA BIOS supports LCD. Besides, it also accepts interlaced and non-interlaced analog monitors (color and monochrome VGA) with high-resolution quality while maintaining complete IBM VGA compatibility. But digital monitors (i.e. MDA, CGA, and EGA) can be NOT supported. Multiple frequency (multi-sync) monitors are operated as if they were analog monitors.

5.1.2 Display memory

Having 1.5 ~ 4 MB UMA memory, the VGA controller can make CRT displays or color panel displays perform with resolutions up to 1024 x 768 at 64 K colors. The display memory can be modified up to 4 MB in BIOS for true-color resolution of 1024 x 768.

5.1.3 Display drivers

1. Win95,98 drivers(VGA & Audio) in driver CDROM
Vga \ MediaGX \ Win9X \ National Geode Win9x
Drivers1.2.exe

2. WinNT4.0 drivers in driver CDROM
Vga \ MediaGX \ Nt40 \

5.2 Further Information

For more detailed information about the PCI/SVGA installation in your WAFER-5825, including driver updates, troubleshooting instructions, please refer to the following webs which provide some resources you may need. If not find the information you need, please contact with your local contributor or ICP support team:

ICP web site: www.iei.com.tw

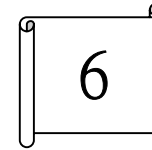

Audio

6.1 Introduction

With on-board audio interface, the WAFER-5825 can perform high-quality stereo sound and FM music synthesis (ESFM) by using the CX5530 audio controller. The audio interface has functions of recording, compressing, and playing back voice, sound, and music with a built-in mixer control. In addition, the on board audio interface supports the Plug and Play (PnP) standard and provides PnP configuration for audio, FM, and MPU-104 logical devices. It is compatible with AC97 version 2.0, voice, and music functions. The ESFM synthesizer is register compatible with the OPL3 and has extended capabilities.

6.1.1 Audio drivers

1. Installing software driver in Windows NT

The driver was provided from the CD utility.
WinNT4.0 Audio drivers in Driver CDROM
Audio \ MediaGX \ Nt40 \

2. Installing software driver in Win95/98

The audio drivers will be installed automatically while you install the display driver.

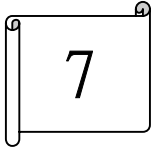

PCI Bus Ethernet Interface

7.1 Introduction

The WAFER-5825 provides a high performance 32-bit Ethernet chipset which is completely compliant with IEEE 802.3 100 Mbps CSMA/CD standards. It is both 100Base-T and 10Base-T compatible. The major network operating system fits it. The medium type can be set up via the RSET8139.exe program included on the utility CD.

The Ethernet port supplies a standard RJ-45 connector on board. To utilize the network boot feature is by incorporating the boot ROM image files for the appropriate network operating system. The boot ROM BIOS files are combined with system BIOS, which can be enabled/disabled in the BIOS setup.

The 8139x utility tools all in driver CDROM

Lan \ Realtek \ 8139c \

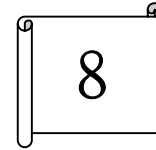

CardBus Interface

8.1 Introduction

The WAFER-5825 provides a high performance 32-bit PCI bus Interface to CardBus interface chipset, which can support the 32-bit CardBus (Card-32), and the 16-bit CardBus (Card-16). It also supports ZV (Zoom Video) Card control interface without external buffers.

8.1.1 Chipset

The R5C475II is a PC card control offering a single chip solution as a bridge between PCI bus and CardBus. Concerning the card control interface, the R5C475II's register set is compatible with the Intel 82365SL and Ricoh's RF5C396/366 in order to maintain backward compatibility with a existing 16-bit PC Card compliant with PCMCIA2.1/JEIDA4.2 so that the existing PC card are available.

8.2 Support

In the CardBus standard adopted by PC Card 95, the data transfer bus was extended to 32bit and bus clock became 33MHz. Since the busmaster mode is also implemented, CardBus is suitable for high performance required multimedia cards such as fast LAN Card, VIDEO Card or graphic processing cards. With the ZV Card such as MPEG cards, Multimedia environment will be easily realized.

16-bit PC Card control interface signals, controlled by the timing synthesizer circuit, are programmable so that not only timing requirement of 16-bit PC Card compliant with PCMCIA2.1/ JEIDA4.2 but also faster timing requirement than it is available.

Recognition of CardBus or 16-bit PC Card is examined automatically when cards are inserted, and the card control interface will be composed properly on the result of recognition. So, CardBus card and 16-bit PC Card are available simultaneously

8.3 Software Support

8.3.1 OS Support

[Windows 98]

R5C475II is fully supported by Windows 98.

8.3.2 R5C475II Installation

[Windows 98]

No configuration is necessary except the general setting of BIOS. (4.3)

Appendix A. Watch-Dog Timer

The WatchDog Timer is a device to ensure that standalone systems can always recover from catastrophic conditions that cause the CPU to crash. This condition may have occurred by external EMI or a software bug. When the CPU stops working normally, hardware on the board will perform hardware reset (cold boot) to bring the system back to a known state.

Three I/O ports control the WatchDog Timer.

543	Write	Set Watch-Dog Time period
543 (hex)	Read	Enable the refresh the WatchDog Timer.
143/943 (hex)	Read	Disable the WatchDog Timer.

Prior to enable the WatchDog Timer, user has to define Timer first. The output data is a value of time interval and the range of the value is from 01(hex) to FF (hex) and time interval 1 sec to 255 sec.

Data	Time Interval
01	1 sec
02	2 sec
03	3 sec
04	4 sec
.	.
.	.
.	.
FF	255 sec

This will enable and activate the countdown timer which will eventually time out and reset the CPU to ensure that this reset condition does not occur, the Watch-Dog Timer must be periodically refreshed by reading the same I/O port 143/943H and

543H. This must be done within the time out period that is selected by software, please refer to the example program.

A tolerance of at least 5% must be maintained to avoid unknown routines within the operating system (DOS), such as disk I/O that can be very time consuming. Therefore if the time out period has been set to 10 seconds, the I/O port 543H must be read within 7 seconds.

Note: when exiting a program it is necessary to disable the WatchDog Timer, otherwise the system will reset.

Example assembly program:

```
TIMER_PORT    = 543H
TIMER_START   = 543H
TIMER_STOP    = 943H
```

```
:: INITIAL TIME PERIOD COUNTER
```

```
MOV DX, TIME_PORT
```

```
OUT AL, 8:8 SECONDS
```

```
:: ADD YOUR APPLICATION HERE
```

```
MOV DX, TIMER_START
```

```
IN AL, DX.    ;; START COUNTER
```

```
:: ADD YOUR APPLICATION HERE
```

```
W_LOOP:
```

```
MOV DX, TIMER_STOP
```

```
IN AL, DX
```

```
MOV DX, TIMER_START
```

```
IN AL, DX.    ;; RESTART COUNTER
```

```
:: ADD YOUR APPLICATION HERE
```

```
CMP EXIT_AP, 0
```

```
JNE W_LOOP
```

```
MOV DX, TIMER_STOP
```

```
IN AL, DX
```

```
:: EXIT AP
```

Appendix B. I/O Address Map

B.1 System I/O Address Map

I/O Address Map	Description
000-01F	DMA Controller #1
020-021	Interrupt Controller # 1, Master
022-023	Chipset address
040-05F	System Timer
060-06F	Standard 101/102 keyboard Controller
070-07F	Real time Clock, NMI Controller
080-0BF	DMA Page Register
0A0-0BF	Interrupt Controller # 2
0C0-0DF	DMA Controller # 2
0F0-0F0	Clear Math Coprocessor Busy
0F1-0F1	Reset Math Coprocessor
0F8-0FF	Math Coprocessor
1F0-1F8	VIR BUS Master PCI IDE Controller
200-207	Game I/O
278-27F	Reserved
2F8-2FF	Serial Port 2
378-37F	Parallel Printer Port 1
3B0-3DF	Cyrix Graphic Adapter
3F0-3F7	Floppy Disk Controller
3F8-3FF	Serial Port 1
543	Watch dog timer enable
143/943	Watch dog timer disable

PnP audio I/O map range from 220~250H (16 bytes)

MPU-401 select from 300~330H (2 bytes)

B.2 DMA channel assignments

Channel	Function
0	Available
1	Audio*
2	Floppy disk (8-bit transfer)
3	Parallel**
4	Cascade for DMA controller 1
5	Audio*
6	Available
7	Available

* Audio DMA defaults setting: DMA 1.5

Audio High DMA select: DMA 1.3

Audio Low DMA select: DMA 5.6.7

** Parallel port DMA default setting: DMA 3

Parallel port DMA select: DMA 1.3

B.3 Interrupt assignments

Interrupt #	Interrupt source
NMI	Parity error detected
IRQ 0	System timer
IRQ 1	Keyboard
IRQ 2	Interrupt from controller 2 (cascade)
IRQ 8	Real-time clock
IRQ 9	Available
IRQ 10	Available
IRQ 11	Available
IRQ 12	PS/2 mouse
IRQ 13	Numeric data processor
IRQ 14	Fixed disk controller
IRQ 15	USB controller
IRQ 3	Serial communication port 2
IRQ 4	Serial communication port 1
IRQ 5	Audio*
IRQ 6	Diskette controller (FDC)
IRQ 7	Parallel port 1 (print port)

* Audio default setting: IRQ5

Ethernet IRQ is automatic set by the system

B.4 1st MB memory map

Address	Description
F000h-FFFFh	System ROM
D800h-EFFFh	Unused
C800h-D7FFh	Ethernet ROM*
C000h-C7FFh	Expansion ROM*
B800h-BFFFh	CGA/EGA/VGA text
B000h-B7FFh	Unused
A000h-AFFFh	EGA/VGA graphics
0000h-9FFFh	Base memory
D000-D400H	Available

* Default setting

** If Ethernet boot ROM is enabled.