

# CM313HR Communications utilityModule™

## User's Manual

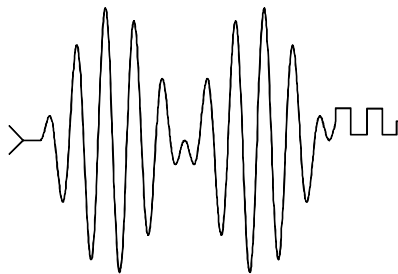

*rttd* USA

Real Time Devices USA, Inc.  
*"Accessing the Analog World"®*

Publication No. CM313HR 12.04.2001



---

---

# CM313HR

## Communications utilityModule™

### User's Manual

---

---

**REAL TIME DEVICES USA, INC.**  
PO Box 906  
103 Innovation Blvd.  
State College, PA 16804-0906 USA

Phone: (814) 234-8087

FAX: (814) 234-5218

E-Mail

[sales@rtdusa.com](mailto:sales@rtdusa.com)

[techsupport@rtdusa.com](mailto:techsupport@rtdusa.com)

Website

[www.rtdusa.com](http://www.rtdusa.com)

## Revision History

10/18/2001	Initial release
12/4/2001	Added drawing for RS-422/485 configuration

**Notice:** We have attempted to verify all information in this manual as of the publication date. Information in this manual may change without prior notice from Real Time Devices USA.

Published by  
Real Time Devices USA, Inc.  
103 Innovation Blvd.  
P.O. Box 906  
State College, PA 16804-0906 USA

Copyright 2001 by Real Time Devices USA, Inc.  
All rights reserved  
Printed in U.S.A.

PC/XT, PC/AT are registered trademarks of IBM Corporation.  
PC/104 is a registered trademark of PC/104 Consortium.  
The Real Time Devices Logo is a registered trademark of Real Time Devices USA, Inc.  
utilityModule is a trademark of Real Time Devices.  
Windows, Windows NT, Windows 95 are trademarks of Microsoft.  
All other trademarks appearing in this document are the property of their respective owners.

# Table of Contents

<b>CHAPTER 1 INTRODUCTION.....</b>	<b>1-1</b>
CM313HR Communications utilityModule .....	1-1
<b>Features .....</b>	<b>1-1</b>
Connectors and Switches .....	1-2
Recommended Cables.....	1-2
General Specifications .....	1-2
<b>Configuring the utilityModule.....</b>	<b>1-2</b>
Jumpers and Switches .....	1-3
<b>Ethernet EEPROM Configuration.....</b>	<b>1-7</b>
<b>CHAPTER 2 INSTALLING THE UTILITYMODULE .....</b>	<b>2-1</b>
<b>Recommended Procedure.....</b>	<b>2-1</b>
<b>Finding Pin 1 of Connectors .....</b>	<b>2-1</b>
<b>PC/104 Bus Connectors, CN1 and CN2.....</b>	<b>2-2</b>
<b>First COM port, CN3 .....</b>	<b>2-4</b>
<b>Second COM port, CN4 .....</b>	<b>2-7</b>
<b>Third COM port, CN5 .....</b>	<b>2-7</b>
<b>Fourth COM port, CN6 .....</b>	<b>2-7</b>
Base Address of Common Registers.....	2-8
Common Register definitions.....	2-8
<b>10Base-T connector, CN8.....</b>	<b>2-10</b>
<b>10Base-T connector, CN10.....</b>	<b>2-11</b>
<b>10Base-2 connector, CN14 .....</b>	<b>2-11</b>
<b>Power Protection Circuitry.....</b>	<b>2-12</b>
<b>CHAPTER 3 USING THE UTILITYMODULE SERIAL PORTS .....</b>	<b>3-1</b>
1.5 Mbps support .....	3-1
Interrupt Sharing.....	3-1
<b>CHAPTER 4 USING THE UTILITYMODULE ETHERNET PORTS.....</b>	<b>4-1</b>
Diagnostic LEDs.....	4-1
Boot ROM Socket .....	4-1
Power Consumption .....	4-2
Solder Jumpers .....	4-2
<b>CHAPTER 5 SOFTWARE INSTALLATION.....</b>	<b>5-3</b>
Software installation.....	5-3
The ISMC9000.EXE Program.....	5-3
The 313DIAG.EXE Program.....	5-3

Software drivers.....	5-4
<b>CHAPTER 6 REFERENCE INFORMATION.....</b>	<b>6-5</b>
Ethernet References.....	6-5
Types of Ethernet.....	6-5
Types of Ethernet cable.....	6-6
10Base-T Wiring Convention .....	6-7
Ethernet frames.....	6-8
IEEE 802 MAC number .....	6-8
<b>CHAPTER 7 RETURN POLICY AND WARRANTY.....</b>	<b>7-1</b>
Return Policy.....	7-1
Limited Warranty .....	7-2

## Table of Tables

Table 1 Default Jumper Settings .....	1-4
Table 2 Switch and Jumper tables.....	1-5
Table 3 Base address table for COM ports .....	1-7
Table 4 Connector Table .....	2-2
Table 5 PC/104 XT Bus Connector .....	2-3
Table 6 PC/104 AT Bus Connector .....	2-4
Table 7 Connector CN3 in RS-232 Mode.....	2-5
Table 8 Connector CN3 pin location in RS-232 Mode.....	2-5
Table 9 Connector CN3 in RS422/485 Mode.....	2-6
Table 10 Connector CN3 pin location in RS422/485 Mode .....	2-6

## Table of Figures

Figure 1 Switch & Jumper Locations.....	1-3
Figure 2 Connector Locations.....	2-2



# Chapter 1 INTRODUCTION

---

This manual gives information on the CM313HR Communications utilityModule. This module supports four versatile serial ports with jumper configurable IRQ lines and I/O addresses and one 10Base-T / 10Base-2 Ethernet interface for your PC/104 applications.

## CM313HR Communications utilityModule

The CM313HR Communications utilityModule was designed to provide four versatile serial ports and an Ethernet interface to support the Real Time Devices cpuModules and other standard PC/104 processor modules.

## Features

The following are major features of the CM313HR utilityModule.

### Serial ports

- Compatibility with the Industry Standard 16C550
- Up to 1.5 Mbps baud transmit/receive operation (24 MHz)
- 16 byte transmit FIFO/16 byte receive FIFO with error flags
- Independent transmit and receive control
- Standard modem interface
- Jumper selectable to interrupt line, base address, RS232/RS422-485 mode per port
- Jumper selectable enable/disable per port
- Includes 42 different selectable I/O base addresses
- Extended temperature range: -40 to +85C
- Low power-consumption
- Typical from single +5V power supply

### Ethernet

#### SMC9000 compatible Ethernet controller

- SMC 91C96I chipset
- Internal 6k RAM

#### Multiple Ethernet interfaces

- 10Base-T UTP (unshielded twisted pair)
- 10Base-2 BNC

#### Software Configurable

- Jumperless configuration for I/O address, interrupt, mode
- Configuration stored in EEPROM

#### Boot ROM socket

- Allows remote booting of cpuModule from file server

#### Software Included

- Self-explanatory diagnostic program included
- Windows Drivers
- Ethernet configuration program

## Connectors and Switches

Connectors provided are:

- CN1: PC/104 Bus (XT)
- CN2: PC/104 Bus (AT)
- CN3: First COM port
- CN4: Second COM port
- CN5: Third COM port
- CN6: Fourth COM port
- CN8: 10Base-T port (RJ45)
- CN14: 10Base-2 port (BNC)

Switches provided are:

- SW1: COM ports address selection

Jumpers provided are:

- JP1: First COM port IRQ
- JP2: Second COM port IRQ
- JP3: Third COM port IRQ
- JP4: Fourth COM port IRQ
- JP5: Serial port clock source select
- JP6: Ethernet default settings
- JP8: First COM port mode and termination
- JP9: Second COM port mode and termination
- JP10: Third COM port mode and termination
- JP11: Fourth COM port mode and termination

## Recommended Cables

XK-CM30

## General Specifications

- Dimensions: 3.8 x 3.9 x 0.6" (97 x 100 x 16 mm)
- Weight (mass): 3.0 ounces (85 grams)
- 6-layer PCB
- Operating conditions:
  - Temperature: -40 - +85 degrees C
  - Relative humidity: 0 - 95%, non-condensing
- Storage temperature: -55 to +125 degrees C

## ***Configuring the utilityModule***

The following sections contain information on configuring the utilityModule.

Please read this entire section before attempting to use the utilityModule!

## Jumpers and Switches

### Locations

The figure below shows switch and jumper locations.

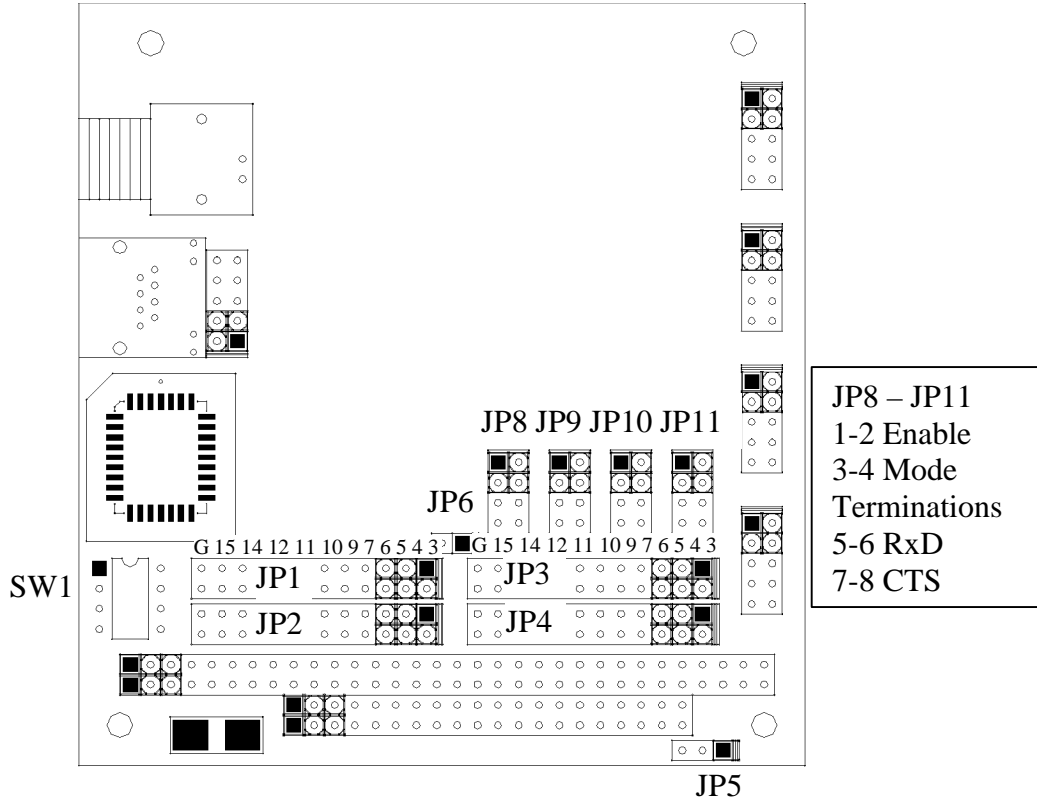

**Figure 1 Switch & Jumper Locations**

### Default Settings

The utilityModule is delivered from the factory configured according to the following table.

**Table 1 Default Jumper Settings**

<b>Jumper</b>	<b>Setting</b>	<b>Function</b>
JP1 G jumper	3-4 Installed	IRQ4 for 1 <sup>st</sup> COM port 1K pull down resistor on IRQ4 line
JP2 G jumper	1-2 Installed	IRQ3 for 2 <sup>nd</sup> COM port 1K pull down resistor on IRQ3 line
JP3 G jumper	5-6 Installed	IRQ5 for 3 <sup>rd</sup> COM port 1K pull down resistor on IRQ5 line
JP4 G jumper	13-14 Installed	IRQ10 for 4 <sup>th</sup> COM port 1K pull down resistor on IRQ10 line
JP5 CLK jumper	2-3 installed	24 MHz / 13 input clock is selected for serial ports
JP6 Ethernet Config	1-2 open	Ethernet Configuration set to software configuration
JP8 First COM port	1-2 open	Enable port
	3-4 installed	Select RS-232 mode
	5-6 open	No termination on RxD (Not required for RS-232 mode)
	7-8 open	No termination on CTS (Not required for RS-232 mode)
JP9 Second COM port	1-2 open	Enable port
	3-4 installed	Select RS-232 mode
	5-6 open	No termination on RxD (Not required for RS-232 mode)
	7-8 open	No termination on CTS (Not required for RS-232 mode)
JP10 Third COM port	1-2 open	Enable port
	3-4 installed	Select RS-232 mode
	5-6 open	No termination on RxD (Not required for RS-232 mode)
	7-8 open	No termination on CTS (Not required for RS-232 mode)
JP11 Fourth COM port	1-2 open	Enable port
	3-4 installed	Select RS-232 mode
	5-6 open	No termination on RxD (Not required for RS-232 mode)
	7-8 open	No termination on CTS (Not required for RS-232 mode)
SW1	All down	I/O base addresses at 3E8, 2E8, 280, 288 for 1 <sup>st</sup> , 2 <sup>nd</sup> , 3 <sup>rd</sup> and 4 <sup>th</sup> COM port respectively

### Descriptions

The following table describes the functions of the jumpers.

**Table 2 Switch and Jumper tables**

<b>Jumper</b>	<b>Use</b>
<b>JP 1</b>	IRQ selection for COM1 G setting: jumper installed = 1K pull down resistor for the selected IRQ Jumper removed = no pull down for the selected IRQ  Default: 3-4, IRQ4 is selected for CN3 with G jumper installed (1K pull-down)
<b>JP 2</b>	IRQ selection for COM2 G setting: jumper installed = 1K pull down resistor for the selected IRQ Jumper removed = no pull down for the selected IRQ  Default: 1-2, IRQ3 is selected for CN4 with G jumper installed (1K pull-down)
<b>JP3</b>	IRQ selection for COM3 G setting: jumper installed = 1K pull down resistor for the selected IRQ Jumper removed = no pull down for the selected IRQ  Default: 5-6, IRQ5 is selected for CN5 with G jumper installed (1K pull-down)
<b>JP 4</b>	IRQ selection for COM4 G setting: jumper installed = 1K pull down resistor for the selected IRQ Jumper removed = no pull down for the selected IRQ  Default: 13-14, IRQ10 is selected for CN6 With G jumper installed (1K pull-down)
<b>JP5</b>	Input clock selection for serial ports 1-2 = select 24 MHz input clock to UART 2-3 = select 24 MHz / 13 input clock to UART  Default: 2-3 jumped, to select 1.8432 MHz to UART
<b>JP6</b>	Ethernet Configuration Selection 1-2 installed = Use hardware default configuration for Ethernet 1-2 open = Use software programmable configuration  Default: 1-2 open to enable software programmable configuration
<b>JP8 First COM port</b>	COM port configuration 1-2 open = Enable Port 1-2 installed = Disable Port 3-4 installed = select RS-232 mode 3-4 open = select RS-422/485 mode 5-6 installed = 120 ohm termination on RxD (for RS422/485 modes) 5-6 open = No termination on RxD (RS422/485 modes) 7-8 installed = 120 ohm termination on CTS (for RS422/485 modes) 7-8 open = No termination on CTS (RS422/485 modes)  Default: 3-4 installed, 1-2, 5-6 and 7-8 open to select enabled for RS-232 mode with no termination

<b>JP9</b> <b>Second</b> <b>COM port</b>	<p>COM port configuration</p> <ul style="list-style-type: none"> <li>1-2 open = Enable Port</li> <li>1-2 installed = Disable Port</li> <li>3-4 installed = select RS-232 mode</li> <li>3-4 open = select RS-422/485 mode</li> <li>5-6 installed = 120 ohm termination on RxD (for RS422/485 modes)</li> <li>5-6 open = No termination on RxD (RS422/485 modes)</li> <li>7-8 installed = 120 ohm termination on CTS (for RS422/485 modes)</li> <li>7-8 open = No termination on CTS (RS422/485 modes)</li> </ul> <p>Default: 3-4 installed, 1-2, 5-6 and 7-8 open to select enabled for RS-232 mode with no termination</p>
<b>JP10</b> <b>Third</b> <b>COM port</b>	<p>COM port configuration</p> <ul style="list-style-type: none"> <li>1-2 open = Enable Port</li> <li>1-2 installed = Disable Port</li> <li>3-4 installed = select RS-232 mode</li> <li>3-4 open = select RS-422/485 mode</li> <li>5-6 installed = 120 ohm termination on RxD (for RS422/485 modes)</li> <li>5-6 open = No termination on RxD (RS422/485 modes)</li> <li>7-8 installed = 120 ohm termination on CTS (for RS422/485 modes)</li> <li>7-8 open = No termination on CTS (RS422/485 modes)</li> </ul> <p>Default: 3-4 installed, 1-2, 5-6 and 7-8 open to select enabled for RS-232 mode with no termination</p>
<b>JP11</b> <b>Fourth</b> <b>COM port</b>	<p>COM port configuration</p> <ul style="list-style-type: none"> <li>1-2 open = Enable Port</li> <li>1-2 installed = Disable Port</li> <li>3-4 installed = select RS-232 mode</li> <li>3-4 open = select RS-422/485 mode</li> <li>5-6 installed = 120 ohm termination on RxD (for RS422/485 modes)</li> <li>5-6 open = No termination on RxD (RS422/485 modes)</li> <li>7-8 installed = 120 ohm termination on CTS (for RS422/485 modes)</li> <li>7-8 open = No termination on CTS (RS422/485 modes)</li> </ul> <p>Default: 3-4 installed, 1-2, 5-6 and 7-8 open to select enabled for RS-232 mode with no termination</p>
<b>SW1</b>	<p>I/O base address switch. See Base Address Table for details</p> <p>Default: All down = I/O base addresses at 3E8, 2E8, 280, 288 for 1<sup>st</sup>, 2<sup>nd</sup>, 3<sup>rd</sup> and 4<sup>th</sup> COM port respectively</p>

**Table 3 Base address table for COM ports**

COM port addresses –base address in Hex for eight 8-bit registers							
SW1-4	SW-3	SW-2	SW-1	CN3	CN4	CN5	CN6
Down	Down	Down	Down	3E8	2E8	280	288
Down	Down	Down	Up	280	288	290	298
Down	Down	Up	Down	290	298	2A0	2A8
Down	Down	Up	Up	2A0	2A8	2B0	2B8
Down	Up	Down	Down	100	108	110	118
Down	Up	Down	Up	120	128	130	138
Down	Up	Up	Down	140	148	150	158
Down	Up	Up	Up	160	168	170	178
Up	Down	Down	Down	100	108	500	508
Up	Down	Down	Up	120	128	520	528
Up	Down	Up	Down	280	288	680	688
Up	Down	Up	Up	290	298	690	698
Up	Up	Down	Down	2E8	2A8	6E8	6A8
Up	Up	Down	Up	2F8	3E8	2E8	6E8
Up	Up	Up	Down	3E8	2E8	7E8	6E8
Up	Up	Up	Up	3F8	2F8	3E8	2E8

## ***Ethernet EEPROM Configuration***

The most important configuration options for the Ethernet section are set using the configuration program ISMC9000.EXE, and then stored in a configuration EEPROM.

ISMC9000 is used to select:

- I/O Address
- Hardware interrupt number
- Media Type
- Boot PROM Address

## Default Settings

The factory default settings for CM313HRSET options are:

<b>Option</b>	<b>Factory Default</b>
I/O address	320h
Interrupt	IRQ2/9
Media type	10Base-T
Boot PROM	Disabled

Please refer to page 5-3 for information on changing these settings using ISMC9000.EXE.

## Chapter 2 **INSTALLING THE UTILITYMODULE**

---

Since the utilityModule uses a PC/104 stackthrough bus, the only hardware installation you will do is placing the module to the PC/104 stack. To do this, you will connect the PC/104 bus connector with the matching connector of another module.

### ***Recommended Procedure***

We recommend you follow the procedure below to ensure that stacking of the modules does not damage connectors or electronics.

- Turn off power to the PC/104 system or stack.
- Select and install standoffs to properly position the utilityModule on the PC/104 stack.
- Touch a grounded metal part of the stack to discharge any buildup of static electricity.
- Remove the utilityModule from its anti-static bag.
- Check that keying pins in the PC/104 bus connector are properly positioned.
- Check the stacking order: make sure an XT bus card will not be placed between two AT bus cards, or it will interrupt the AT bus signals.
- Hold the utilityModule by its edges and orient it so the bus connector pins line up with the matching connector on the stack.
- Gently and evenly press the utilityModule onto the PC/104 stack.

---

**CAUTION:** Do not force the module onto the stack! Wiggling the module or applying too much force may damage it. If the module does not readily press into place, remove it, check for bent pins or out-of-place keying pins, and try again.

---

Connecting the utilityModule

The following sections describe connectors of the utilityModule.

### ***Finding Pin 1 of Connectors***

A white area silk-screened on the PC board indicates pin 1 of connectors. A square solder pad visible on the bottom of the PC board also indicates it.

#### ***Locations***

The figure below shows connector locations.

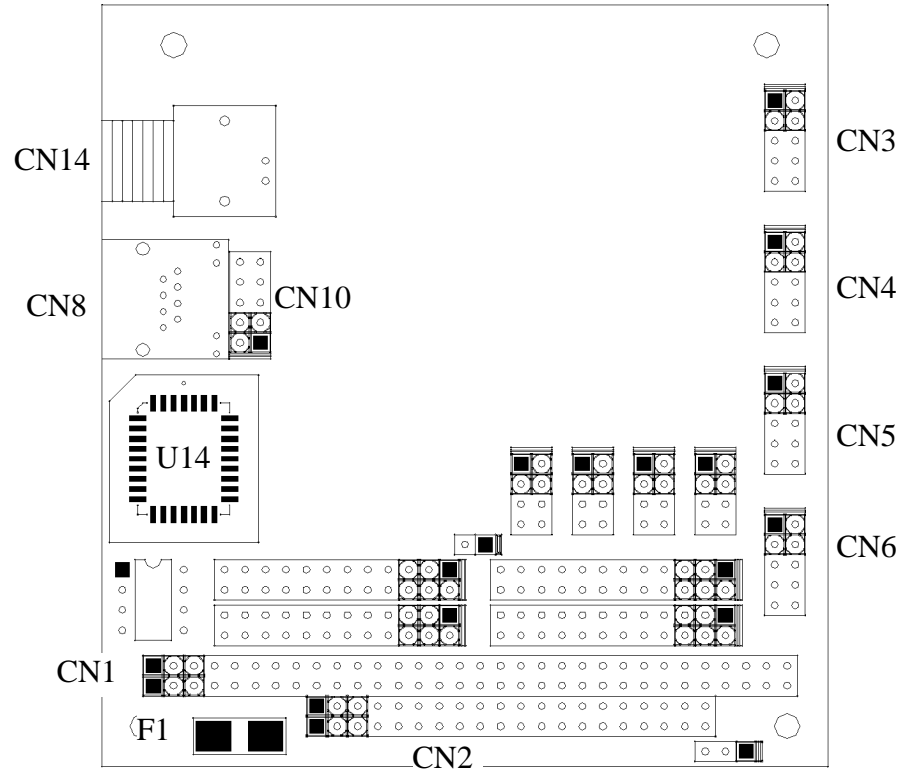

Figure 2 Connector Locations

Table 4 Connector Table

Connector	Function	Size
CN1	PC/104 XT Bus	64 pin
CN2	PC/104 AT Bus	40 pin
CN3	1 <sup>st</sup> COM port	10 pin
CN4	2 <sup>nd</sup> COM port	10 pin
CN5	3 <sup>rd</sup> COM port	10 pin
CN6	4 <sup>th</sup> COM port	10 pin
CN8	10Base-T	RJ45
CN10	10Base-T	10 pin
CN14	10Base-2	BNC

## PC/104 Bus Connectors, CN1 and CN2

Connectors CN1 and CN2 provide PC/104 bus connections. CN1 carries XT bus signals, and CN2 carries additional signals for the AT bus. The signals on CN1 and CN2 conform to the IEEE P966 standard for the PC/104 bus.

The following tables list the connector pinouts:

Table 5 PC/104 XT Bus Connector

PC/104 XT Bus Connector, CN1		
Pin	Row A	Row B
1	IOCHCHK*	0V
2	SD7	RESETDRV
3	SD6	+5V
4	SD5	IRQ9
5	SD4	-5V
6	SD3	DRQ2
7	SD2	-12V
8	SD1	ENDXFR*
9	SD0	+12V
10	IOCHRDY	(KEYING PIN)
11	AEN	SMEMW*
12	SA19	SMEMR*
13	SA18	IOW*
14	SA17	IOR*
15	SA16	DACK3
16	SA15	DRQ3
17	SA14	DACK1*
18	SA13	DRQ1
19	SA12	REFRESH
20	SA11	SYSCLK
21	SA10	IRQ7
22	SA9	IRQ6
23	SA8	IRQ5
24	SA7	IRQ4
25	SA6	IRQ3
26	SA5	DACK2*
27	SA4	TC
28	SA3	BALE
29	SA2	+5V
30	SA1	OSC
31	SA0	0V
32	0V	0V

**Table 6 PC/104 AT Bus Connector**

PC/104 AT Bus Connector, CN2		
Pin	Row C	Row D
0	0V	0V
1	SBHE*	MEMCS16*
2	LA23	IOCS16*
3	LA22	IRQ10
4	LA21	IRQ11
5	LA20	IRQ12
6	LA19	IRQ15
7	LA18	IRQ14
8	LA17	DACK0*
9	MEMR*	DRQ0
10	MEMW*	DACK5*
11	SD8	DRQ5
12	SD9	DACK6*
13	SD10	DRQ6
14	SD11	DRQ6
15	SD12	DRQ7
16	SD13	+5V
17	SD14	MASTER*
18	SD15	0V
19	(KEYING PIN)	0V

---

**Note:** Two locations on the bus have mechanical keying pins to help prevent misconnection of the PC/104 bus. These keying pins are a part of the PC/104 standard, and we strongly recommend you leave them in place.

If you have other modules without keying pins, we suggest you modify them to include keying.

---

### ***First COM port, CN3***

The first serial port is implemented on connector CN3. It can be configured as a PC compatible full duplex RS232 port or as half- or full duplex RS422 or RS485 through mode jumper JP8. The I/O address is configurable in respect to SW1 address table, and corresponding interrupt is also selectable through jumper JP1 to be IRQ3, IRQ4, IRQ5, IR6, IRQ7, IRQ9, IRQ10, IRQ11, IRQ12, IRQ14 and IRQ15. But you need to make sure that there are no resource conflicts on the I/O base address and interrupt line you choose.

The serial port is implemented with a 16C550-compatible UART (Universal Asynchronous Receiver/Transmitter). This UART is capable of baud rates up to 1.5 M with the 24 MHz clock input and 115.2K with the 24 MHz / 13 clock input.

## RS232 Serial Port (Default)

The full-duplex RS232 mode is the default setting on the utilityModule. With this mode enabled, connector CN3 must be connected to RS232 compatible devices. The following table gives the connector pinout and shows how to connect to an external serial connector, either DB25 or DB9 compatible.

### Connector CN3 in RS-232 Mode

**Table 7 Connector CN3 in RS-232 Mode**

CN3 Pin	Signal	Function	In/out	DB25	DB9
1	DCD	Data Carrier Detect	In	8	1
2	DSR	Data Set Ready	In	6	6
3	RXD	Receive Data	In	3	2
4	RTS	Request To Send	Out	4	7
5	TXD	Transmit Data	Out	2	3
6	CTS	Clear To Send	In	5	8
7	DTR	Data Terminal Ready	Out	20	4
8	RI	Ring Indicate	In	22	9
9,10	GND	Signal Ground	--	7	5

Facing the connector pins, the pinout is pictured in the following,

**Table 8 Connector CN3 pin location in RS-232 Mode**

9	7	5	3	1
GND	DTR	TXD	RXD	DCD
GND	RI	CTS	RTS	DSR
10	8	6	4	2

## RS422 or RS485 Serial Port

You can change the mode switch to set the first port as RS422 or RS485. In this case, you must connect CN3 to an RS422 or RS485 compatible device. When using RS422 or RS485 mode, you can use the port in either half-duplex (two-wire) or full-duplex (four-wire) configurations. For half-duplex (2-wire) operation, you must connect RXD+ to TDX+, and connect RXD- to TXD-.

---

Note! Two 120-ohm termination resistors are provided on the utilityModule. Termination is usually necessary on all RS-422 receivers and at the ends of the RS-485 bus. If the termination resistor is required, closing jumper JP8 5-6 for RxD and/or 7-8 CTS can enable it.

---

### RS422 and RS485 Mode Pinout

The following table gives the pinout of connector CN3 when RS422 or RS485 modes are enabled.

**Table 9 Connector CN3 in RS422/485 Mode**

CN3 Pin	Signal	Function	In/out	DB9
1	RTS-	Request to send (-)	Out	1
2	RTS+	Request to send (+)	Out	6
3	RXD-	Receive Data (-)	In	2
4	TXD+	Transmit Data (+)	Out	7
5	TXD-	Transmit Data (-)	Out	3
6	RXD+	Receive Data (+)	In	8
7	CTS-	Clear to send (-)	In	4
8	CTS+	Clear to send (+)	In	9
9,10	GND	Signal Ground	--	5

Facing the connector pins, the pinout is pictured in the following,

**Table 10 Connector CN3 pin location in RS422/485 Mode**

9	7	5	3	1
GND	CTS+	TXD+	RXD+	RTS+
GND	CTS-	RXD-	TXD-	RTS-
10	8	6	4	2

### ***Notes on using RS422 or RS485 Modes***

When using the serial port in RS422 or RS485 mode, the serial receiver is always enabled, however the serial transmitter is enabled and disabled under software control in the following two ways.

By default, the transmitter is enabled by manipulating the Request To Send (RTS\*) signal of the serial port controller. Writing bit 1 of the Modem Control Register (MCR) as follows controls this signal:

- If MCR bit 1 = 1, then RTS\* = 0, and serial transmitter is disabled
- If MCR bit 1 = 0, then RTS\* = 1, and serial transmitter is enabled

For more information on the serial port registers, including the MCR, please refer to a standard PC-AT hardware reference for the 16C550 UART, or refer to RTDUSA application note ANC102 at <http://www.rtdusa.com>

The other way to enable the serial transmitter is to write 1 to its corresponding bit of the utilityModule's internal common register 4, which sets the serial transmitter in "always on" mode. Please refer to Internal Common Register Section for detail.

The drivers are disabled in RS-422/485 mode at power up. You must enable the drivers by writing a 1 to the driver enable bit of the utilityModule's internal common register 4. Please refer to Internal Common Register Section for detail.

### ***Second COM port, CN4***

Please refer to the previous section on the first COM port CN3 for the description on CN4.

### ***Third COM port, CN5***

Please refer to the previous section on the first COM port CN3 for the description on CN5.

### ***Fourth COM port, CN6***

Please refer to the previous section on the first COM port CN3 for the description on CN6.

## CM313HR common registers

The utilityModule includes 5 common registers to provide additional information and software control that is not required for normal COM port operation, but may be helpful in determining the status of the board and configuring of the board. The following two sections give the location and definition of the common registers.

### Base Address of Common Registers

The utilityModule common registers are located 800h above the address of the first enabled COM port. That is, assuming that “X” in hex is the first enabled COM port base address, which can be any of the valid addresses listed in the Com Port Address Table, the base address for the common registers is “Y” in hex, then,

$$Y = X + 800h$$

For example, if the switches of SW4 are set all DOWN position which makes CN3 = 3E8h, CN4 = 2E8h, CN5 = 280h and CN6 = 288h, then according to the algorithm, the common registers base address (BA) will be the following depending the setting of enable switch SW2 for each serial port,

If CN3 is enabled then,

$$BA = 3E8h + 800h = BE8h$$

Else if CN3 is disabled AND CN4 is enabled then,

$$BA = 2E8h + 800h = AE8h$$

Else if CN3 and CN4 are disabled AND CN5 is enabled then,

$$BA = 280h + 800h = A80h$$

Else if CN3, CN4 and CN5 are disabled AND CN4 is enabled then,

$$BA = 288h + 800h = A88 A80h$$

Else if CN3, CN4, CN5 and CN6 are disabled then,

Common Registers are disabled

End If

### Common Register definitions

BA + 0 – Interrupt Status (Read Only)							
7	6	5	4	3	2	1	0
Reserved	Reserved	TxRDY*	RxRDY*	CN6	CN5	CN4	CN3

For each CNx bit:

0 = Not interrupting

1 = Interrupt set

TxRDY\*

0 = indicates a buffer ready for at least one of the four transmit channels

1 = indicates that all transmit buffers are full

RxRDY\*

0 = indicates one or more of the receive channels has data ready to read

1 = indicates that all receive buffers are empty

Reserved reads as 0

<b>BA + 1 – Address Switch (Read Only)</b>							
7	6	5	4	3	2	1	0
Reserved	Reserved	Reserved	Reserved	SW1-4	SW1-3	SW1-2	SW1-1

For each bit, see table above

0 = Down

1 = Up

Reserved reads as A to tag on the address register.

<b>BA + 2 -- Enable/Disable Jumpers (Read Only)</b>							
7	6	5	4	3	2	1	0
Reserved	Reserved	Reserved	Reserved	CN6	CN5	CN4	CN3

For each CNx bit:

Jumper installed = 0 = Port is disabled

Jumper open = 1 = Port is enabled

Reserved reads as 0

<b>BA + 3—Reserved</b>							
7	6	5	4	3	2	1	0
Reserved	Reserved	Reserved	Reserved	Reserved	Reserved	Reserved	Reserved

Reserved reads as 0

<b>BA + 4-- RS-422 RTS operation (W)</b>							
7	6	5	4	3	2	1	0
Reserved	Reserved	Driver Enable	IntSel	CN6	CN5	CN4	CN3

Driver Enable:

0 = All ports in RS-422/485 mode will have the drivers disabled

1 = All ports in RS-422/485 mode will have the drivers controlled as selected in register 4 and 5

Default to 0 to have drivers disabled during power up. User must program to a 1 to use RS-422/485 mode.

IntSel:

0 = MCR bit-3 controls the three state interrupt output.

1 = Overrides MCR bit-3 and interrupt outputs are enabled continuously.

Default to 0 to set COM ports in normal mode

For each CNx bit:

0 = use RTS to enable transmitter, default case

1 = transmitter always on

<b>BA + 5-- RS-422 TxD operation (W)</b>							
7	6	5	4	3	2	1	0
TxD+/-CN6	TxD+/-CN5	TxD+/-CN4	TxD+/-CN3	CN6	CN5	CN4	CN3

For each CNx bit:

0 = use RTS to enable transmitter or transmitter always on as defined by BA + 4 register CNx bit

1 = Use TxD to enable transmitter, transmitter data is tied low

For each TxD+/-CNx bit if corresponding CNx bit is 1:

0 = Use TxD to enable transmitter

1 = Use inverted TxD to enable transmitter

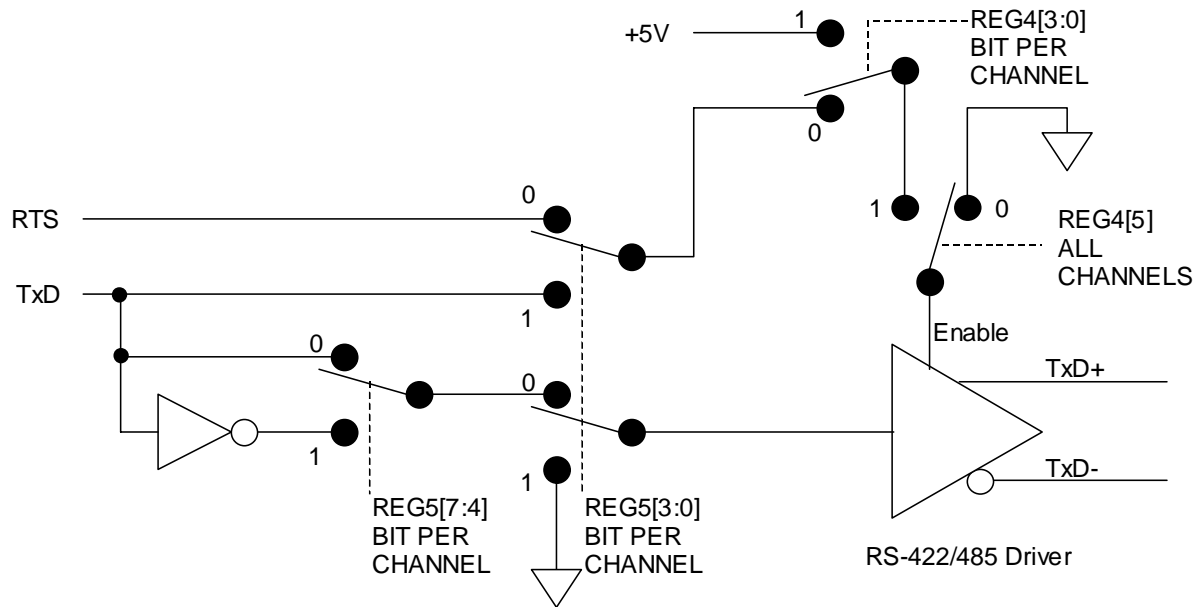

RS-422/485 mode configuration. All switches are shown in power on default conditions.

## 10Base-T connector, CN8

Connector CN8 is for UTP (Unshielded Twisted Pair) wiring normally used for 10Base-T Ethernet. It is wired in parallel with CN10. Don't try to use both CN8 and CN10 at the same time.

The following table gives the pinout of CN8.

Pin	Signal	Function	in/out
1	TX+	Transmit +	out
2	TX-	Transmit -	out
3	RX+	Receive +	in
4	N.C.	not connected	
5	N.C.	not connected	
6	RX-	Receive -	in
7	N.C.	not connected	
8	N.C.	not connected	

The figure below shows the pin numbering of CN8 when **looking into the connector**:

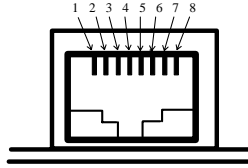

RJ-45 Jack Connector

CN8 is a standard female RJ-45 connector. One example of a mating plug is:

- AMP 5-554739-3 (unshielded)

## 10Base-T connector, CN10

Connector CN10 is for UTP (Unshielded Twisted Pair) wiring normally used for 10Base-T Ethernet. It is wired in parallel with CN8. Don't try to use both CN8 and CN10 at the same time.

The following table gives the pinout of CN10.

Pin	Signal	Function	in/out
1	TX+	Transmit +	out
2	RX-	Receive -	in
3	TX-	Transmit -	out
5	RX+	Receive +	in
4, 6 - 10	N.C.	not connected	

## 10Base-2 connector, CN14

Connector CN14 is a BNC bayonet connector for coaxial cable normally used with 10Base-2 Ethernet.

The pinout of CN14 is:

Pin	Signal	Function	in/out
1	SIGNAL	Signal to 50 ohm cable	in/out
2	GND	Signal Ground	--

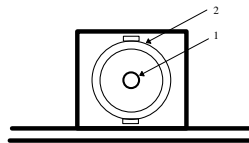

BNC Connector CN14

## ***Power Protection Circuitry***

To reduce the risk of damage due to power-supply problems, the utilityModule includes several protective components.

### ***Module Power-Supply Protection***

The utilityModule includes a component to help prevent damage due to problems with the +5Vdc power supply from the PC/104 bus. Protection is provided for:

- Over-current
- Reversed polarity
- Excessive voltage

This protection is only for the utilityModule, and will not protect other devices in a PC/104 stack.

The protective fuse is replaceable and is available from electronics suppliers. Its description and part number is:

Littelfuse Nano<sup>2</sup> SMF 1.0 amp, R451-001

---

**Caution:** Replace fuses only with parts of identical current and voltage rating.

---

## Chapter 3 USING THE UTILITYMODULE SERIAL PORTS

---

The utilityModule features an EXAR quad UART 16C550 compatible 16C554D part.

### *EXAR Documentation*

Due to the complexity of the EXAR serial chip, it is impossible for us to reproduce all programming information in this manual. If you will be doing in-depth programming of the serial port controller, we suggest you obtain the 16C554D datasheet from the manufacturer.

The 16C554D datasheet is available on-line in electronic format as an Adobe Acrobat (. PDF) file on the EXAR website:

[www.exar.com](http://www.exar.com)

You may also contact:

EXAR Corporation  
248720 Kato Road  
Fremont, CA 94538

Or by phone/fax:

Phone: 510 668 7017  
Fax: 510 668 7017

### **1.5 Mbps support**

With 24 MHz clock input selected (JP5, 1-2), the utilityModule is capable of provide data rates up to 1.5 Mbps in RS422/RS485 mode. The RS-232 buffers restrict the data rate to 120 Kbps in RS-232 mode.

### **Interrupt Sharing**

Interrupt sharing is a mechanism which allows different devices sharing same active high IRQ lines on the PC/104 bus, given that there is a interrupt sharing circuit associated with each device. The utilityModule provides interrupt-sharing circuits for all the serial ports; thus it allows sharing of one IRQ line among the serial ports in the utilityModule. However, user needs to be careful to share an IRQ line with devices in the system elsewhere, and be sure that other devices also share their IRQ lines as well. For instance, users should be aware of that the IRQ3/IRQ4 associated with serial port J3/J4 on RTDUSA cpuModule are not shareable. And if the utilityModule is in the same system with RTDUSA cpuModule, be advised not to use/share IRQ3/IRQ4 for the utilityModule unless you have serial ports on the cpuModule disabled.

Interrupt sharing in a PC/104 system requires one 1K pull-down resistor per IRQ line for all the devices that share the IRQ. Installing a G jumper in the utilityModule will pull its associated IRQ line down with a 1K resistor. That is, for example, if IRQn is shared among four serial ports on the utilityModule, only one G jumper needs to be installed for IRQn line. If more than one G jumper are installed, the pull-down on IRQn line will be much stronger that expected 1K-ohm, which will prevent interrupt controller from functioning correctly.

Let consider two cases to demonstrate the concepts for the above discussion. Let us assume that IRQ5 and IRQ10 are not used and driven by other devices in the system. For the first case, IRQ10 line is shared among the four serial ports and for the second case IRQ5 is shared for port 1 and port 2, while IRQ10 is shared among port 3 and port 4.

The following two tables listed the interrupt jumper settings for each case respectively.

**Table 11 Jumper Settings for interrupt sharing Case 1**

<b>Jumper</b>	<b>Setting</b>	<b>Function</b>
JP1 G jumper	13-14 Installed	IRQ10 for 1 <sup>st</sup> COM port 1K pull down resister added on IRQ10 from PORT1
JP2 G jumper	13-14 Removed	IRQ10 for 2 <sup>nd</sup> COM port No pull down resister added on IRQ10 from PORT2
JP3 G jumper	13-14 Removed	IRQ10 for 3 <sup>rd</sup> COM port No pull down resister added on IRQ10 from PORT3
JP4 G jumper	13-14 Removed	IRQ10 for 4 <sup>th</sup> COM port No pull down resister added on IRQ10 from PORT4

**Table 12 Jumper Settings for interrupt sharing Case 2**

<b>Jumper</b>	<b>Setting</b>	<b>Function</b>
JP1 G jumper	5-6 Installed	IRQ5 for 1 <sup>st</sup> COM port 1K pull down resister added on IRQ5 from PORT1
JP2 G jumper	5-6 Removed	IRQ5 for 2 <sup>nd</sup> COM port No pull down resister added on IRQ5 from PORT2
JP3 G jumper	13-14 Installed	IRQ10 for 3 <sup>rd</sup> COM port 1K pull down resister added on IRQ10 from PORT3
JP4 G jumper	13-14 Removed	IRQ10 for 4 <sup>th</sup> COM port No pull down resister added on IRQ10 from PORT4

## Chapter 4 USING THE UTILITYMODULE ETHERNET PORTS

Using the utilityModule is straightforward, and essentially identical to any other Ethernet card.

When CM313HR module is powered on, data in the EEPROM on board is transferred to Ethernet controller's internal configuration registers. The data in the EEPROM contains information configuration such as the base address of the card, the active interrupt line on the PC/104 bus for Ethernet access, the media type in use, etc. The factory default setting of the board is at I/O address 0x320 and IRQ 2/9. And if there is a resource conflicting, you need to change your setting on CM313HR with the other I/O boards removed temporarily by executing CM313HRSET program as described in a later chapter.

The following sections describe:

- Diagnostic LEDs
- Boot ROM socket
- Power Consumption

### ***Diagnostic LEDs***

CN8, the RJ45 connector, has two LEDs that are used to indicate status and provide some diagnostic information in case of malfunctions.

Name	Meaning	Normal State
TX/RX	Transmit or Receive data	Flashing with traffic
LNK	Link established (UTP)	On (10Base-T only)

#### ***TX/RX LED***

The yellow LED normally flashes when there is traffic on the network. It will flash for either transmit or receive data.

#### ***LNK LED***

The green LED is turned on when a valid 10Base-T link is detected by the chipset. It is only active when using the 10Base-T UTP connection with link integrity checking enabled. If it is off, the UTP wiring may be broken or incorrect, link integrity checking may be disabled, or you may be using the 10Base-2 or AUI interface.

### ***Boot ROM Socket***

In some applications, you may wish to use the boot ROM socket of the utilityModule to boot a connected cpuModule from a remote server.

The socket will accommodate a 32 pin PLCC EPROM or Flash memory devices of size 8k, 16k, 32k, or 64k bytes. The device must be a byte-wide architecture.

The boot ROM feature can be enabled using the CM313HRSET program described on page 5-3.

## Power Consumption

Power consumption of the utilityModule depends on which Ethernet interface is used and the degree of activity on the network.

The following table gives typical power consumption:

Configuration	AUI	TP	BNC
Consumption	200 mA	200 mA	200 mA

## Solder Jumpers

The CM113HR has solder jumpers to configure the system. The table below gives the details.

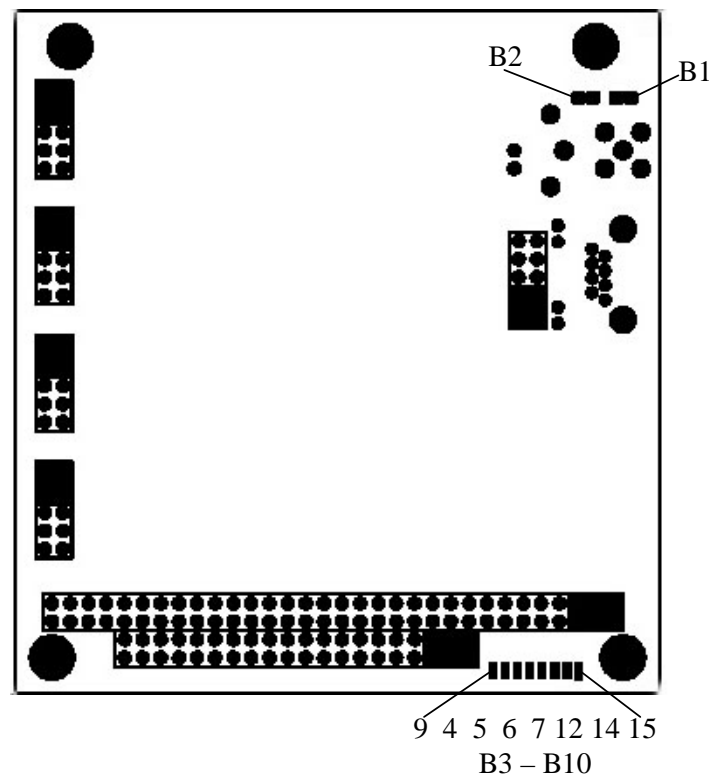

The following table gives the solder jumper functions:

Jumper	Default Setting	Function
B1	Open	Short will connect isolated 10Base-2 ground to chassis ground at mounting hole
B2	Open	Short will connect isolated 10Base-2 ground to board ground
B3 - B10	9	Sets the IRQ that is used when IRQ 2 is selected in the setup software. One and only one of these solder jumpers should be shorted.

---

## Chapter 5 SOFTWARE INSTALLATION

---

This chapter contains information on:

- Software installation
- ISMC9000.EXE Ethernet setup program
- DIAG313.EXE Serial port diagnostic
- Software Drivers

### ***Software installation***

There is no installation program for the supplied software. We suggest you create a directory named \CM313HR on your target drive, and copy all files and subdirectories from the supplied floppy disk into that directory.

### ***The ISMC9000.EXE Program***

The supplied floppy disk contains the Ethernet setup utility ISMC9000.EXE.

#### **Using ISMC9000.EXE**

The CM313HR utility module is completely software configurable with all its configuration data stored in EEPROM, ISMC9000.EXE is a utility program that let you view or change the existing setting of the board. Jumper JP6 is provided to allow a hardware default setting. You can view these settings by selecting configuration "JP6 Closed" in the program then selecting Display Configuration. The hardware default settings cannot be modified.

When you run the ISMC9000.EXE program, the utility looks at all possible I/O addresses. If no module is found or if there is a conflict, the utility quits with a message.

When the module is found and correctly operating, the utility displays a menu of options.

You can use the program to change settings for I/O address, Interrupt, Media Type, Remote Boot Prom, and compatibility mode and save your selection to EEPROM. These settings then are recalled from EEPROM whenever the module is reinitialized.

### ***The 313DIAG.EXE Program***

The supplied floppy disk contains the serial diagnostic utility 313DIAG.EXE.

This menu driven DOS utility will enable you to test the serial ports using internal and external loop back and confirm the operation.

## **Software drivers**

The floppy supplied with the utilityModule contains the following (or newer) versions of drivers.

### NDIS2 Drivers

- DOS
- Windows for Workgroups
- OS/2/Windows NT3.x, NT4.x

### NDIS3/4 Drivers

- Windows9x
- Windows NT4
- Windows 2000

For Linux, Unix and Novell drivers and driver updates contact SMSC's website at [www.smsc.com](http://www.smsc.com).

The direct link for LAN91C96I drivers is:

[http://www.smsc.com/main/catalog/lan91c96i.html#Additional Information](http://www.smsc.com/main/catalog/lan91c96i.html#Additional%20Information)

## Chapter 6 REFERENCE INFORMATION

This chapter contains reference information concerning:

- Ethernet References
- Types of Ethernet
- Types of Ethernet Cable
- Ethernet Frames
- IEEE 802 MAC Number

### *Ethernet References*

To learn more about Ethernet, you might start with:

Charles Spurgeon's Ethernet Website:

<http://wwwhost.ots.utexas.edu/ethernet/ethernet-home.html>

This site provides thorough overviews of 10 Mbps and faster Ethernet.

### *Types of Ethernet*

There are three standard types of 10 Megabit Ethernet, of which 10Base-T is by far the most common, and 10Base-5 is by far the least common.

<b>Ethernet Type</b>	<b>Nickname</b>	<b>Data transfer rate</b>	<b>Topology</b>	<b>Cable type</b>	<b>Maximum Segment length</b>
10Base-T	"Cheapernet"	10 Mbps	Star	100 ohm UTP (unshielded twisted pair)	100 m 328 ft
10Base-2	"Thin" Ethernet	10 Mbps	Bus	RG-58 coaxial	185 m 607 ft
10Base-5	"Thick" Ethernet	10 Mbps	Bus	RG-11 coaxial	500 m 1640 ft

## ***Types of Ethernet cable***

Ethernet uses one of three standard cable types:

<b>Ethernet Type</b>	<b>Cable type</b>	<b>Impedance</b>	<b>Denomination</b>
10Base-T	UTP	100 Ohm	unshielded twisted pair
10Base-2	RG-58	50 Ohm	Ethernet thin
10Base-5	RG-11	50 Ohm	Ethernet thick (yellow cable)

Note: Although 8-conductor telephone wire is commonly used for 10Base-T connections, this type wire is not the correct 100-ohm UTP, as it does not use twisted-pairs. Using such wire may cause excessive crosstalk, resulting in a large number of collisions and poor network performance.

## 10Base-T Wiring Convention

10Base-T Ethernet uses the following wiring convention when connecting a node to a hub. It is suggested you use this convention for consistency:

RJ45 PIN	First End		to	Second End		RJ45 PIN
	Pair No.	wire color		Pair No.	wire color	
1	3	W-G	to	2	W-O	1
2	3	G	to	2	O	2
3	2	W-O	to	3	W-G	3
4	1	BL	to	1	BL	4
5	1	W-BL	to	1	W-BL	5
6	2	O	to	3	G	6
7	4	W-BR	to	4	W-BR	7
8	4	BR	to	4	BR	8

Note: W-G = White-Green  
 G = Green  
 W-O = White-Orange  
 O = Orange  
 W-BL = White-Blue  
 BL = Blue  
 W-BR = White-Brown  
 BR = Brown

## ***Ethernet frames***

The following are standard Ethernet frames.

- ETHERNET\_II      Primarily used by TPC/IP
- ETHERNET\_802.3    Default frame for Netware 3.11
- ETHERNET\_802.2    Default frame for Netware 3.12 and 4.x
- ETHERNET\_SNAP    Primarily used by Appletalk

## ***IEEE 802 MAC number***

The CM202 utilityModule is identified with an Organizationally Unique Identifier (OUI) and company\_id number:

00-D0-81

The MAC (Media Access Control) number of the utilityModule is thus:

00-D0-81-xx-xx-xx

where the last three bytes are the serial number of the board, unique for each adapter.

## Chapter 7 RETURN POLICY AND WARRANTY

---

### ***Return Policy***

If the utilityModule requires repair, you may return it to us by following the procedure listed below:

---

**Caution:** Failure to follow this return procedure will *almost always* delay repair! Please help us expedite your repair by following this procedure.

---

- 1) Read the **Limited Warranty** that follows.
- 2) Contact the factory and request a Returned Merchandise Authorization (RMA) number.
- 3) On a sheet of paper, write the name, phone number, and fax number of a technically competent person who can answer questions about the problem.
- 4) On the paper, write a detailed description of the problem with the product. Answer the following questions:
  - Did the product ever work in your application?
  - What other devices were connected to the product?
  - How was power supplied to the product?
  - What features did and did not work?
  - What was being done when the product failed?
  - What were environmental conditions when the product failed?
- 5) Indicate the method we should use to ship the product back to you.
  - We will return warranty repairs by UPS Ground at our expense.
  - Warranty repairs may be returned by a faster service at your expense.
  - Non-warranty repairs will be returned by UPS Ground or the method you select, and will be billed to you.
- 6) Clearly specify the address to which we should return the product when repaired.
- 7) Enclose the paper with the product being returned.
- 8) Carefully package the product to be returned *using anti-static packaging!* We will not be responsible for products damaged in transit for repair.
- 7) Write the RMA number on the outside of the package.
- 8) Ship the package to:
  - Real Time Devices
  - 103 Innovation Blvd.
  - State College PA 16803
  - USA

## **Limited Warranty**

Real Time Devices USA, Inc. warrants the hardware and software products it manufactures and produces to be free from defects in materials and workmanship for one year following the date of shipment from REAL TIME DEVICES USA. This warranty is limited to the original purchaser of product and is not transferable.

During the one year warranty period, REAL TIME DEVICES USA will repair or replace, at its option, any defective products or parts at no additional charge, provided that the product is returned, shipping prepaid, to REAL TIME DEVICES USA. All replaced parts and products become the property of REAL TIME DEVICES USA. Before returning any product for repair, customers are required to contact the factory for an RMA number.

THIS LIMITED WARRANTY DOES NOT EXTEND TO ANY PRODUCTS WHICH HAVE BEEN DAMAGED AS A RESULT OF ACCIDENT, MISUSE, ABUSE (such as: use of incorrect input voltages, improper or insufficient ventilation, failure to follow the operating instructions that are provided by REAL TIME DEVICES USA, "acts of God" or other contingencies beyond the control of REAL TIME DEVICES USA), OR AS A RESULT OF SERVICE OR MODIFICATION BY ANYONE OTHER THAN REAL TIME DEVICES. EXCEPT AS EXPRESSLY SET FORTH ABOVE, NO OTHER WARRANTIES ARE EXPRESSED OR IMPLIED, INCLUDING, BUT NOT LIMITED TO, ANY IMPLIED WARRANTIES OF MERCHANTABILITY AND FITNESS FOR A PARTICULAR PURPOSE, AND REAL TIME DEVICES EXPRESSLY DISCLAIMS ALL WARRANTIES NOT STATED HEREIN. ALL IMPLIED WARRANTIES, INCLUDING IMPLIED WARRANTIES FOR MERCHANTABILITY AND FITNESS FOR A PARTICULAR PURPOSE, ARE LIMITED TO THE DURATION OF THIS WARRANTY. IN THE EVENT THE PRODUCT IS NOT FREE FROM DEFECTS AS WARRANTED ABOVE, THE PURCHASER'S SOLE REMEDY SHALL BE REPAIR OR REPLACEMENT AS PROVIDED ABOVE. UNDER NO CIRCUMSTANCES WILL REAL TIME DEVICES BE LIABLE TO THE PURCHASER OR ANY USER FOR ANY DAMAGES, INCLUDING ANY INCIDENTAL OR CONSEQUENTIAL DAMAGES, EXPENSES, LOST PROFITS, LOST SAVINGS, OR OTHER DAMAGES ARISING OUT OF THE USE OR INABILITY TO USE THE PRODUCT.

SOME STATES DO NOT ALLOW THE EXCLUSION OR LIMITATION OF INCIDENTAL OR CONSEQUENTIAL DAMAGES FOR CONSUMER PRODUCTS, AND SOME STATES DO NOT ALLOW LIMITATIONS ON HOW LONG AN IMPLIED WARRANTY LASTS, SO THE ABOVE LIMITATIONS OR EXCLUSIONS MAY NOT APPLY TO YOU.

THIS WARRANTY GIVES YOU SPECIFIC LEGAL RIGHTS, AND YOU MAY ALSO HAVE OTHER RIGHTS THAT VARY FROM STATE TO STATE.